



**SPECIFICATION  
FOR  
APPROVAL**

**MODEL : 15.6"Flat surface multi touch monitor  
AMP156W-UDB-AS6**

BASE MODEL :

**Customer's Confirmation**

Approved by:

Reviewed by:

Prepared by:

元眾實業有限公司

**Y.J.E. Display Tech Co., Ltd.**

Approved by:

Reviewed by:

Prepared by:

### Important safety instructions

01. Please read these instructions carefully before using the product and save for later reference.
02. Follow all warnings and instructions marked on the product.
03. Unplug this product from the wall outlet before cleaning. Clean the product with a damp soft cloth. Do not use liquid or aerosol cleaners as it may cause permanent damage to the screen.
04. Do not use this product near water.
05. Do not place this product on an unstable cart, stand, or table.  
The product may fall, causing serious damage to the product.
06. Slots and openings in the cabinet and the back or bottom are provided for ventilation; to ensure reliable operation of the product and to protect it from overheating, these openings must not be blocked or covered.  
The openings should never be placed near or over a radiator or heat register, or in a built-in installation unless proper ventilation is provided.
07. This product should be operated from the type of power indicated on the marking label.  
If you are not sure of the type of power available, consult your dealer or local power company.
08. This product is equipped with a 3-wire grounding type plug, a plug having a third (grounding) pin.  
This plug will only fit into a grounding-type power outlet.  
This is a safety feature. If you are unable to insert the plug into the outlet, contact your electrician to replace your obsolete outlet.  
Do not defeat the purpose of the grounding-type plug.
09. Do not allow anything to rest on the power cord.  
Do not locate this product where persons will walk on the cord.
10. If an extension cord is used with this product, make sure that the total of the ampere ratings on the products plugged into the extension cord does not exceed the extension cord ampere rating. Also make sure that the total of all products plugged into the wall outlet does not exceed 15 amps.
11. Never push objects of any kind into this product through cabinet slots as they may touch dangerous voltage points or short out parts that could result in a risk of fire or electric shock.  
Never spill liquid of any kind on the product.
12. Do not attempt to service this product yourself, as opening or removing covers may expose you to dangerous voltage points or other risks and will void the warranty.  
Refer all servicing to qualified service personnel.
13. Unplug this product from the wall outlet and refer servicing to qualified service personnel under the following conditions:
  - a. When the power cord or plug is damaged or frayed.
  - b. If liquid has been spilled into the product.
  - c. If the product has been exposed to rain or water.
  - d. If the product does not operate normally when the operating instructions are followed.  
Adjust only those controls that are covered by the operating instructions since improper adjustment of other controls may result in damage and will often require extensive work by a qualified technician to restore the product to normal operation.
  - e. If the product has been dropped or the cabinet has been damaged.
  - f. If the product exhibits a distinct change in performance, indicating a need for service.

**Record of Revision**

<b>Version &amp; Date</b>	<b>Page</b>	<b>Old Description</b>	<b>New Description</b>
2016/5/3	All	First Edition for Customer	

**Contents**

No.	Item	Page
	Cover	01
	Important safety instructions	02
	Record of Revision	03
	Contents	04
1.	Introduction	05
(1)	Features	05
(2)	Notice	05
(3)	Check list	05
2.	Installing the monitor	06
(1)	Power & Signal connections	06
(2)	Optional cable connections	06
(3)	Dimensions	07
3.	Using VGA LCD monitor	08
(1)	Key definition	08
(2)	Setup for Operation	09
(3)	OSD menu system	10
4.	Cleaning the monitor	17
5.	Disclaimer	17
6.	Trouble shooting	18
7.	Specifications	19

## Product Specification

### 1. Introduction

#### 1.1 Features

- High contrast color TFT-LCD Monitor support resolution up to 1366\*768.
- Power management system conforms to VESA DPMS and EPA Energy Star standards.
- Full consideration for touch screen installation and application.
- Universal Power adapter.
- Support DDC1 & DDC2B for Plug & Play compatibility.
- Advanced OSD control for picture quality adjustment.
- Detachable stand for wall-mounting adjustment.
- Heavy duty monitor with steel frame.
- Custom design by request.

#### 1.2 Notice

- Do not touch the LCD panel surface with sharp or hard objects.
- Do not use abrasive cleaners, waxes or solvents for cleaning, use only a dry or damp, soft cloth.
- Use only with a high quality, safety-approved, AC/DC power adapter.

#### 1.3 Check List

Before using this monitor, please make sure that all the items listed below are present in your package. Analog color TFT LCD monitor Accessory Box containing:

1	LCD monitor, 15.6"	x1
2	Adapter	x1
3	Power code	x1
4	VGA Cable, L=1.8m	x1
5	Touch Cable,USB,L=1.8m	x1
6	Panel Mount Kit (4pcs)	x1

If any items are missing or damaged, please contact your dealer immediately.

### **2. Installing the Monitor**

The procedures for setting up your TFT LCD monitor are as followings:

#### **2.1 Power & Signal connections**

##### **2.1.1 Power**

Switch off the power of your monitor and computer.

The Power Switch is located on in the center of the monitor.

##### **2.1.2 Power cable connection**

Connect the power cord to the AC outlet, and connect the power to the monitor through the AC/DC adapter.

##### **2.1.3 VGA cable connection**

Plug 15-pin VGA signal cable to the VGA connector in the rear of PC system, and plug the other end to the monitor. Secure cable connectors with screws.

#### **2.2 Optional cable connections**

The LCD monitor is designed to work with a variety of compatible video sources. Due to possible deviations between these video sources, you may have to make adjustments to the monitor settings from the OSD menu when switching between these sources.

These adjustments are made from the OSD menu.

## 2.3 Dimensions

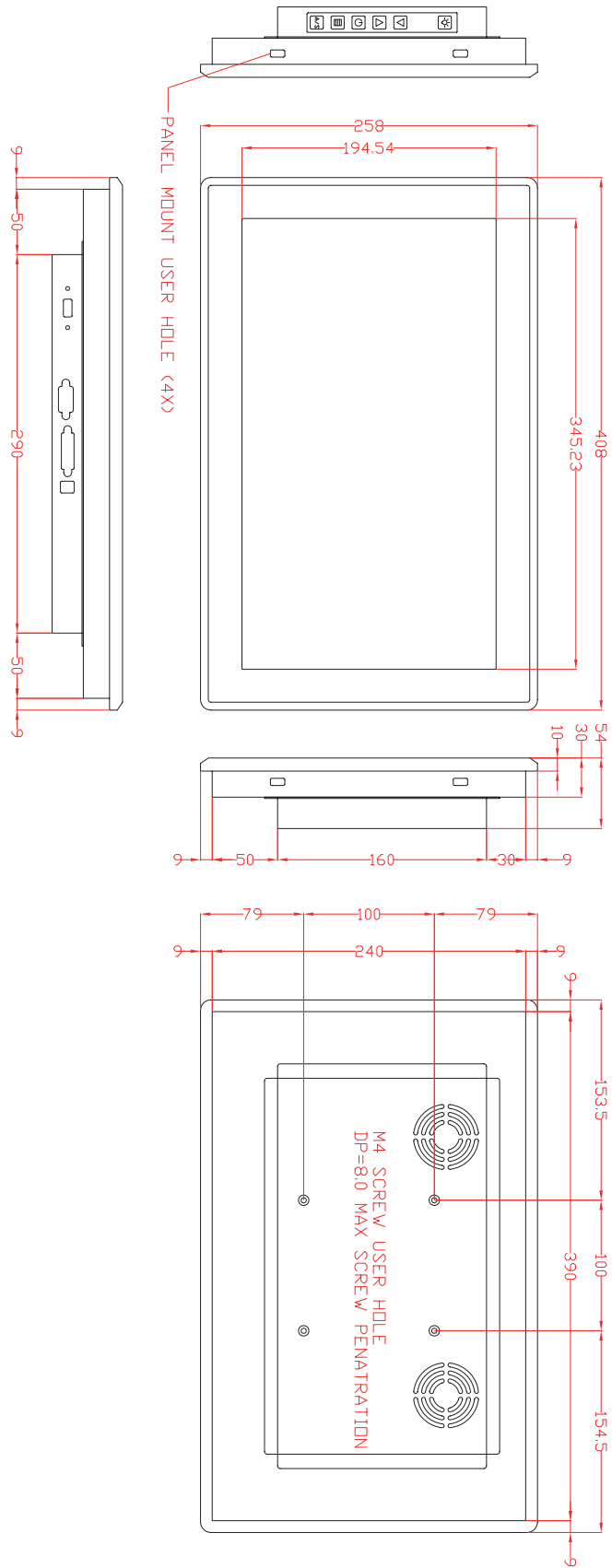

### 3. Using VGA LCD Monitor

#### 3.1 Key Definition

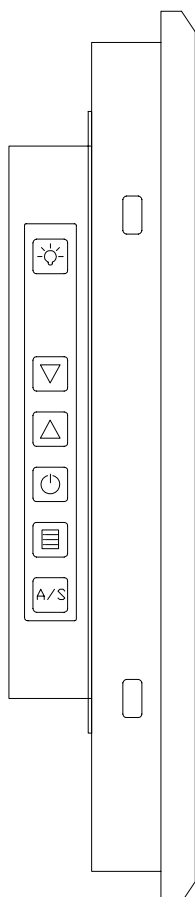

OSD KEY		Function
▼	↓ / ←	Down / value decrease
▲	↑ / →	Up / value increase
⏻	Power	Power ON / OFF
☰	Menu	Menu Select
A/S	Auto	Auto Adjust



## Product Specification

### 3.2 Setup for Operation

The OSD (On Screen Display) menu enables user to manipulate the image and settings OSD Main menu consists of source:

OSD MENU		Description
Auto Adjustment		Automatically adjust the horizontal position, vertical position, horizontal size and phase Windows background or characters should display on your full screen after proceed this function.
Color	Contrast	Adjust the contrast of the screen.
	Brightness	Adjust the brightness of the screen.
	Color Adjust	Choose "User color" can use to set value of Red/Green/Blue.
	Color Temp	Set color to 9300 , 6500 , 5500 , sRGB, User Color .
Image Setting	Clock	Adjust frequency to fill display.
	Phase	Adjust the phase control of the image.
	Gamma	Adjust the value of GAMMA.
	Sharpness	This functuon allows the user to optimize the sharpness of the image.
OSD Menu	OSD H. Pos.	Factory preset, OSD Horizontal Position.
	OSD V. Pos.	Factory preset, OSD Vertical Position.
	OSD Timer	It can adjust OSD display time.
Language		Select one of the 7 languages. (English, Français, Deutsch, Español, Japanese, Chinese Tradition, Chinese Simple)
Misc.	Aspect Ratio	Setting aspect ratio on or off.
	Reset	Return to factory original setting.

## Product Specification

### 3.3 OSD menu system

#### [Color]

Press "+" to increase or "-" to decrease the brightness, contrast or color adjust or color temp.

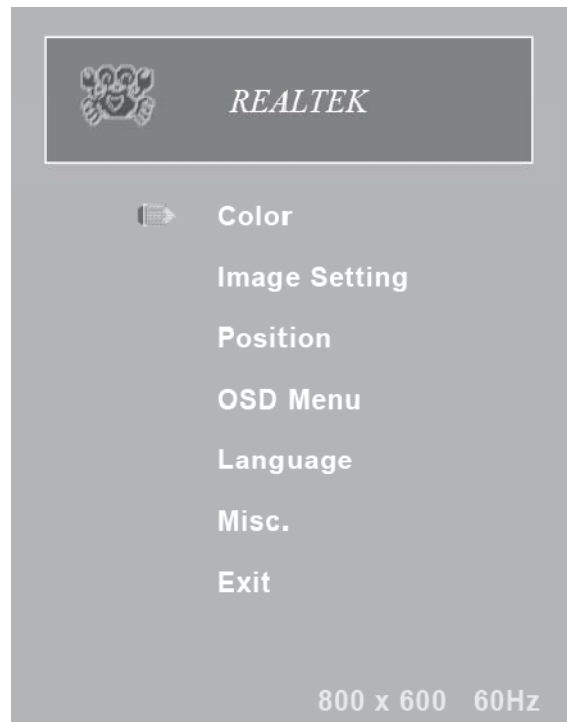

- **Contrast**

Adjust the contrast of the screen.

- **Brightness**

Adjust the brightness of the screen.

- **Color Adjust**

(Notice: please do color temp setting first. After finish color temp, then do color adjust.) Choose "USER" option can set value of Red/Green/Blue.

- **Color Temp**

Set color to 9300 , 6500 , 5500 , sRGB, USER .

You can select the screen's color level of the white color field from the default color temperature settings.

Also, you can fine tune the color temperature by USER option if necessary.

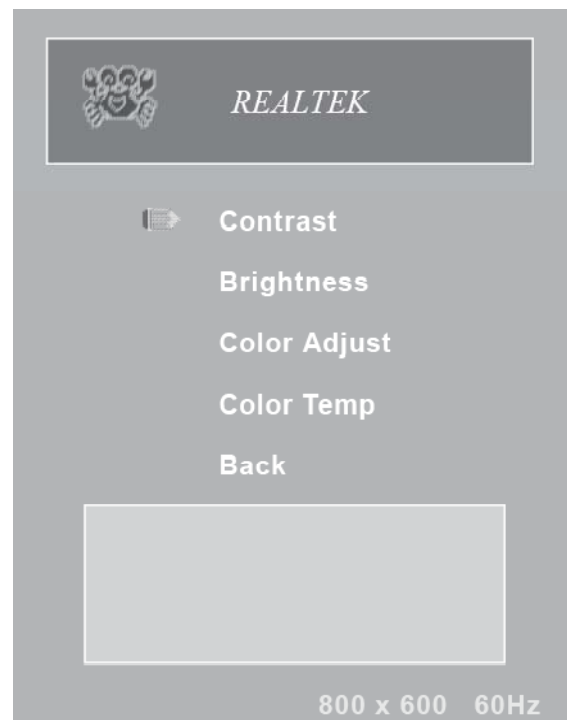

### [Image Setting]

You can adjust the value of screen quality automatically.

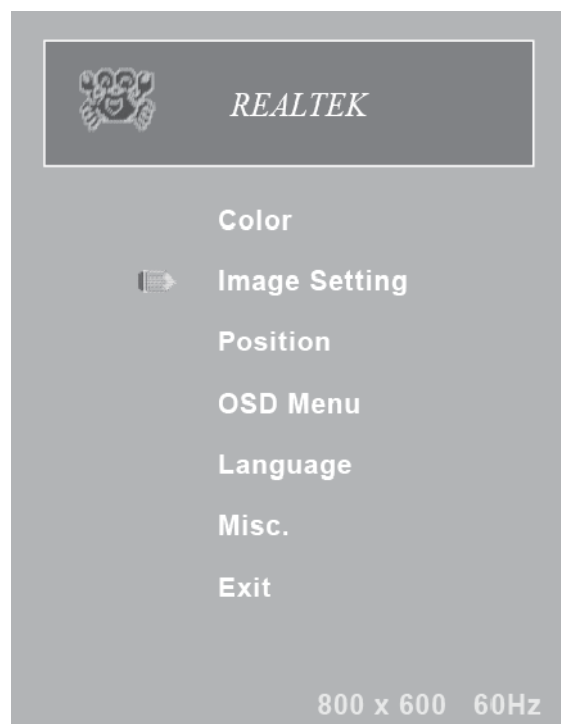

- **Clock**

Adjust frequency to fill display.

- **Phase**

Adjust the phase control of the image.

- **Gamma**

Adjust the value of Gamma.

- **Sharpness**

This function allows the user to optimize the sharpness of the image.

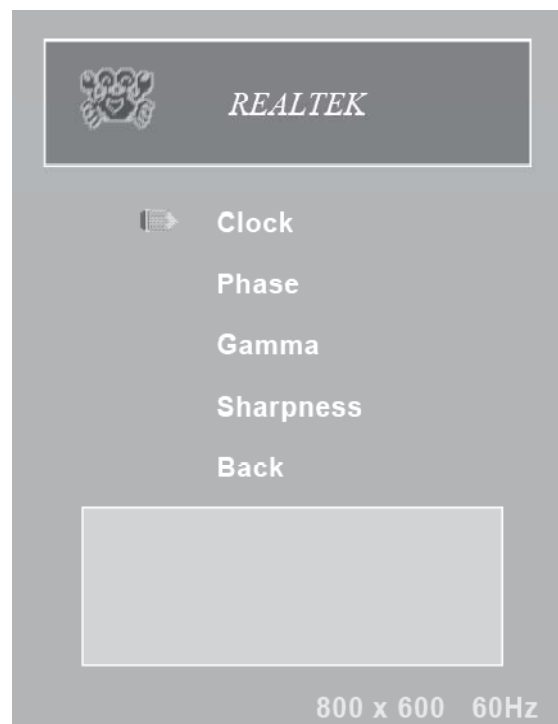

### [Position]

You can adjust the screen's position by horizontal and vertical manually.

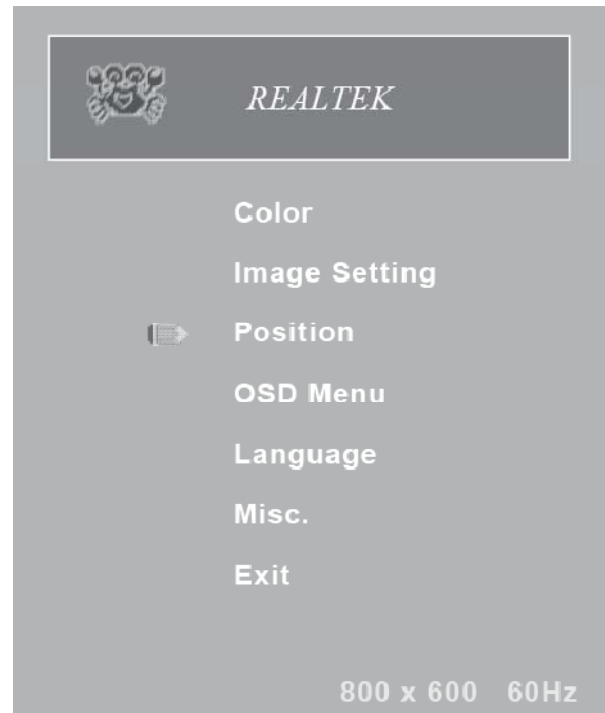

- **H. Position**

Adjust the horizontal position of the screen's image.

- **V. Position**

Adjust the vertical position of the screen's image.

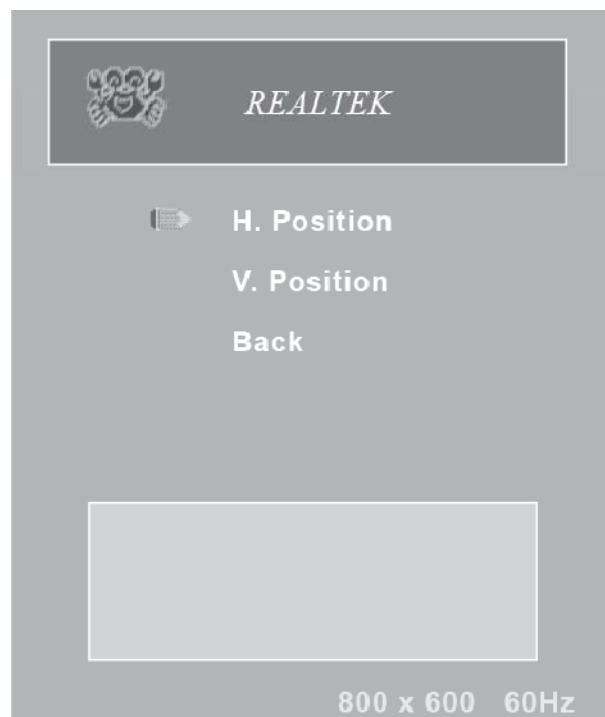

### [OSD Menu]

You can adjust the OSD Menu screen's position by horizontal and vertical manually.

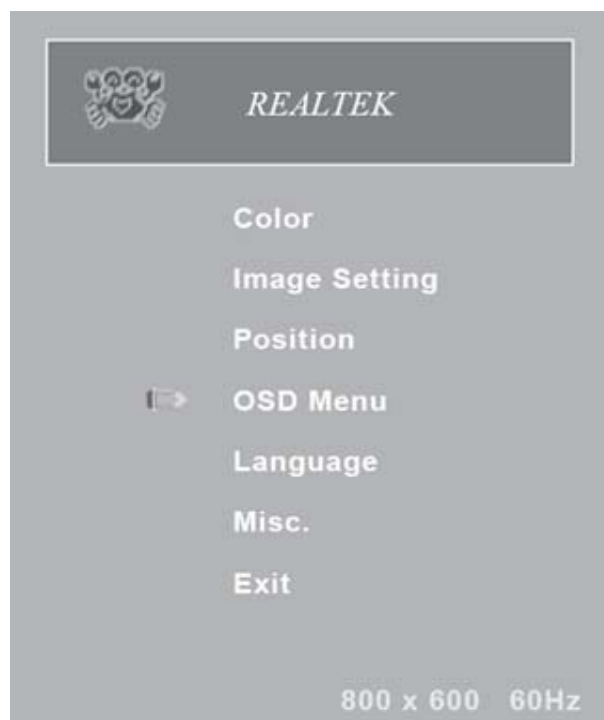

- **OSD H. Pos.**

Adjust the horizontal position of the OSD Menu screen's image.

- **OSD V. Pos.**

Adjust the vertical position of the OSD Menu screen's image.

- **OSD Timer**

Adjust OSD display time.



## Product Specification

### [Language]

Select one of the 7 languages.

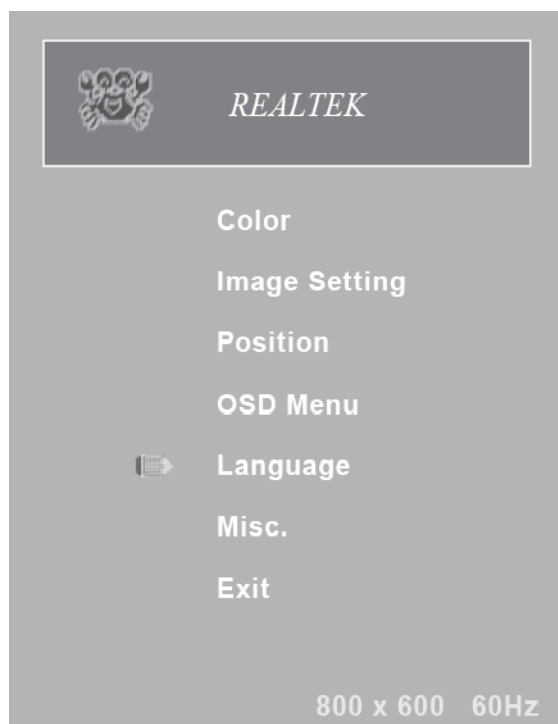

### [Misc.]

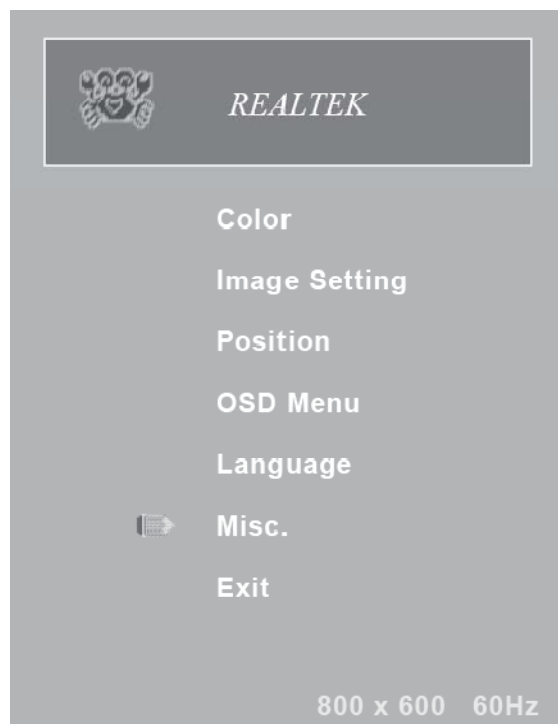

- **Signal Source**

The setting of signal input channel.

- **Reset**

Return to factory original setting.

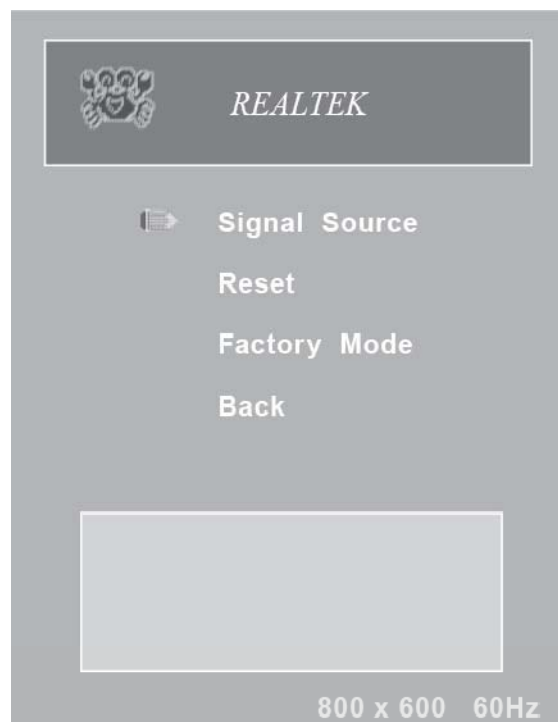

### [Exit]

Exit the OSD Menu.

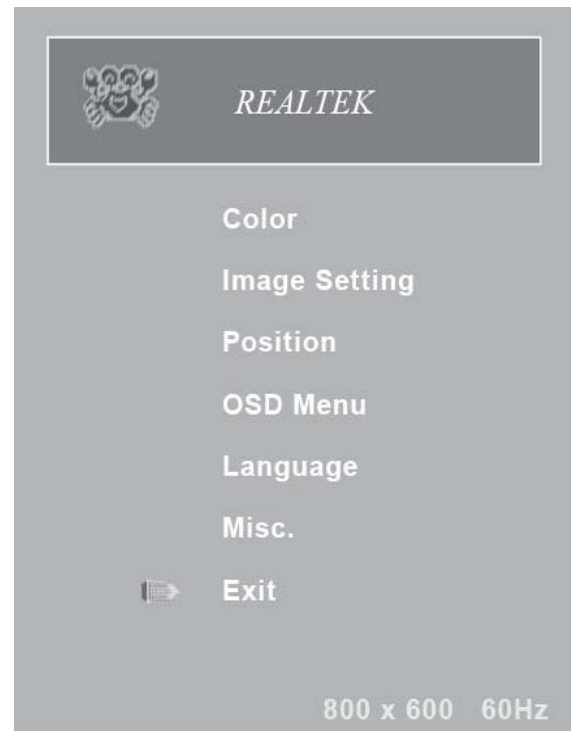



### 4. Cleaning the monitor

1. Make sure the monitor is turned off.
2. Never spray or pour any liquid directly onto the screen or case.
3. Wipe the screen with a clean, soft, lint-free cloth. This removes dust and other particles.
4. The display area is highly prone to be scratched. Do not use ketone-type material (ex. Acetone), Ethyl alcohol, toluene, ethyl acid or Methyl chloride to clean the panel. It may permanently damage the panel and void the warranty.
5. If it is still not clean enough, apply a small amount of non-ammonia, non-alcohol based glass cleaner onto a clean, soft, lint-free cloth, and wipe the screen.
6. Don't use water or oil directly on the monitor.  
If droplets are allowed to dry on the monitor, permanent staining or discoloration may occur.
7. Cleaning Touch Screen: please use dry cloth or soft cloth with neutral detergent (after wring dry) or one with ethanol at cleaning.  
Do not use any organic solvent, acid or alkali solution.

### 5. Disclaimer

We do not recommend using any ammonia or alcohol-based cleaners on the monitor screen or case. Some chemical cleaners have been reported to damage the screen and/or case of the monitor.

## Product Specification

### 6. Trouble shooting

If your monitor fails to operate correctly, consult the following chart for possible solution before calling for repairs:

Condition	Check Point
The picture does not appear	<ul style="list-style-type: none"><li>● Check if the signal cable is firmly seated in the socket.</li><li>● Check if the Power is ON at the computer</li><li>● Check if the brightness control is at the appropriate position, not at the Maximum .</li></ul>
The screen is not synchronized	<ul style="list-style-type: none"><li>● Check if the signal cable is firmly seated in the socket.</li><li>● Check if the output level matches the input level of your computer.</li><li>● Make sure the signal timings of the computer system are within the specification of the monitor.</li><li>● If your computer was working with a CRT monitor, you should check the current signal timing and turn off your computer before you connect the VGA Cable to this monitor.</li></ul>
The position of the screen is not in the center	<ul style="list-style-type: none"><li>● Adjust the H-position, and V-position, or Perform the Auto adjustment.</li></ul>
The screen is too bright (too dark)	<ul style="list-style-type: none"><li>● Check if the brightness or contrast control is at the appropriate position, not at the Maximum (Minimum).</li></ul>
The screen is shaking or waving	<ul style="list-style-type: none"><li>● Press "+" (the Auto - adjustment control) to adjust. Moving all the objects, which emit a magnetic field, such as motor or transformer, away from the monitor. Check if the specific voltage is applied.</li><li>● Check if the signal timing of the computer system is within the specification of monitor.</li></ul>

## Product Specification

### 7. Specifications

Item	Specification
Panel Type	15.6-inch TFT LCD
Screen Diagonal	15.6-inch
Active Display Area (mm)	344.232(H) x 193.536(V)
Pixel Pitch (um)	252 (per one triad) x 252
Number of Pixels	1366(x3) x 768
Contrast Ratio	500:1
Color Arrangement	R.G.B. Vertical Stripe
Brightness (cd/m <sup>2</sup> )	1000 cd/m <sup>2</sup>
Viewing Angle(Typ.)	85/85/85/85 (R/L/U/D)
Signal Connector	15 PIN D-Sub,DVI-D
Power Source	DC12V(+/-10%)
Power Management	VESA DPMS Compliant
Operating Temperature	0 ~ +50 °C
Storage Temperature	-20 ~ +60°C
Plug & Play	VESA DDC 1/2B
Touch Type	Projected Capacitive Touch
Transparency	90%(typ).
Hardness of surface	7H
Linearity	±1.5%(max).

\*Specifications are subject to change without notice\*\*

The LCD Products listed on this document are not suitable for use in aerospace, submarine, nuclear reactor control systems or life support systems. If customers intend to use these LCD products for this type of mission critical applications they should contact our sales department for further input.

Suitable applications include, but are not limited to, the following: Computer and Office equipment, Communications equipment, Test and Measurement equipment, Machine tools, Industrial robots, Audio and Visual equipment.