



Industrial Computer Products Data Acquisition System

ET-7000/PET-7000 Series Register Table



**ET-7000 Series
(Ethernet I/O)**

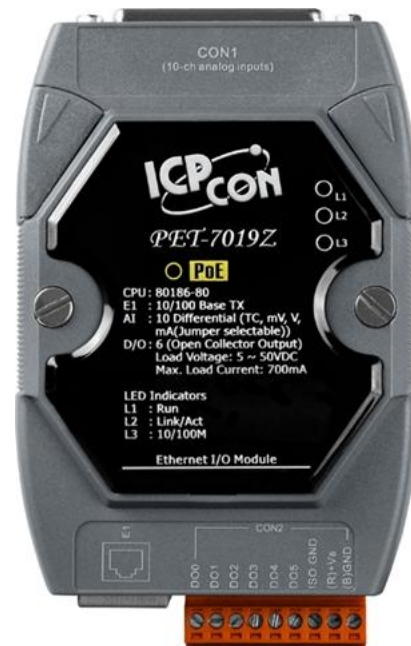

**PET-7000 Series
(PoE I/O)**

Warranty

All products manufactured by ICP DAS are under warranty regarding defective materials for a period of one year, beginning from the date of delivery to the original purchaser.

Warning

ICP DAS assumes no liability for any damage resulting from the use of this product. ICP DAS reserves the right to change this manual at any time without notice. The information furnished by ICP DAS is believed to be accurate and reliable. However, no responsibility is assumed by ICP DAS for its use, nor for any infringements of patents or other rights of third parties resulting from its use.

Copyright

Copyright © 2013 by ICP DAS CO., LTD. All rights are reserved.

Trademarks

Names are used for identification purposes only and may be registered trademarks of their respective companies.

Contact US

If you have any problems, please feel free to contact us.
You can count on us for a quick response.

Email: service@icpdas.com

Table of Contents

Table of Contents	3
Preface.....	4
About this manual	4
Contents in this manual.....	5
ET-7002/PET-7002.....	6
ET-7005/PET-7005.....	12
ET-7015/PET-7015.....	16
ET-7016/PET-7016.....	19
ET-7017/PET-7017	26
ET-7017-10/PET-7017-10	31
ET-7018Z/PET-7018Z	36
ET-7019/PET-7019.....	41
ET-7019Z/PET-7019Z	47
ET-7026/PET-7026.....	54
ET-7042/PET-7042.....	61
ET-7044/PET-7044.....	64
ET-7050/PET-7050.....	67
ET-7051/PET-7051	70
ET-7052/PET-7052.....	73
ET-7053/PET-7053.....	76
ET-7060/PET-7060.....	79
ET-7065.....	82
ET-7066.....	85
ET-7067/PET-7067	87
ET-7083/PET-7083.....	89
Appendix	92
A. Analog Input Type and Data Format Table	93
B. Analog Output Type and Data Format Table	96
Revision History	97

Preface

About this manual

This manual is intended to be used as a reference for users who need to communicate with the ET-7000/PET-7000 over a Modbus network.

This manual assumes that the user has some knowledge of commissioning and programming of Modbus devices, including some knowledge of the Modbus protocol and knowledge about your ET-7000/PET-7000 module.

This manual can be obtained from the companion CD:

- For ET-7000 series module -

CD:\NAPDOS\ET-7000\Document\

or from the ICP DAS FTP site at:

<http://ftp.icpdas.com/pub/cd/6000cd/napdos/et7000/document/>

- For PET-7000 series module -

CD:\NAPDOS\PET-7000\Document\

or from the ICP DAS FTP site at:

<http://ftp.icpdas.com/pub/cd/6000cd/napdos/pet7000/document/>

Contents in this manual

Each chapter contains the following information for each ET-7000/PET-7000 module:

- I/O Specifications
- Pin Assignments
- Wire Connections
- Modbus Register Table

The table below describes the properties of each field in a Modbus register table.

Register fields	Description
Register	The register addresses 1. DEX: Decimal format 2. HEX: Hexadecimal format
Point	The number of the I/O point
Description	The function description for the register address
Data Format	The read or write range of the I/O data
Attribute	The access type R: Read only W: Write only E: Save to the EEPROM
Factory Default	The factory default value after reset. The reset function can be found in the ET-7000/PET-7000 web page, as shown below.

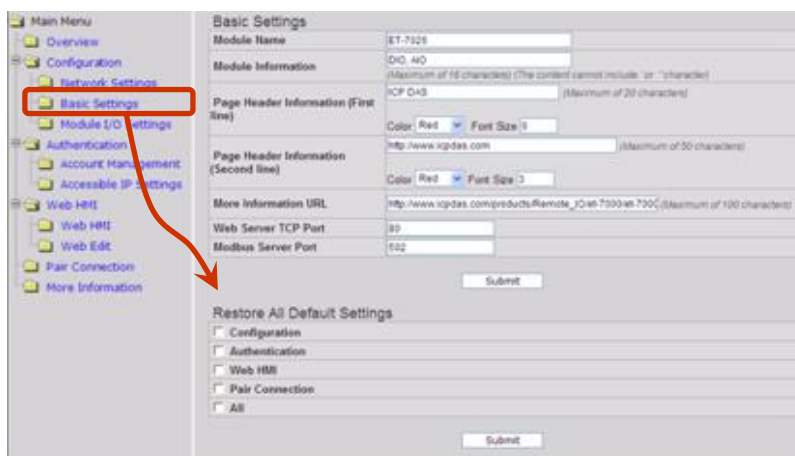

ET-7002/PET-7002

I/O Specifications

Analog Input		
Input Channels	3 (Differential)	
Input Type	+/-150 mV, +/-500 mV, +/-1 V, +/-5 V, +/-10 V, 0~20 mA, +/-20 mA, 4~20 mA (jumper selectable)	
Individual Channel Configuration	Yes	
Resolution	Normal Mode	16-bit
	Fast Mode	12-bit
Sampling Rate	Normal Mode	10 Samples/Sec. (Total)
	Fast Mode	60 Samples/Sec. (Total)
Accuracy	Normal Mode	+/-0.1%
	Fast Mode	+/-0.5% or better
Zero Drift	+/-20 uV/°C	
Span Drift	+/-25 ppm/°C	
Overvoltage Protection	240 Vrms	
Overcurrent Protection	50 mA max. at 110 VDC/VAC max.	
Input Impedance	Voltage	2 MΩ
	Current	124 Ω
Common Mode Rejection	86 dB Min.	
Normal Mode Rejection	100 dB	
Digital Input/Counter		
Input Channels	6	
Type	Wet Contact (Sink or Source)	
On Voltage Level	+10 VDC ~ +50 VDC	
Off Voltage Level	+4V VDC max.	
Input Impedance	10 KΩ, 0.5W	
Counter	Channels	6
	Max. Count	4,294,967,285 (32-bit)
	Max. Input Frequency	100 Hz
	Min. Pulse Width	5 ms
Overvoltage Protection	+50 VDC	
Power Relay		
Output Channels	3	
Operating Voltage Range	Power Relay Form A (SPST N.O.)	
Max. Load Current	5.0 A/Channel at 25°C	
Operate Time	6 ms (Typical)	
Release Time	3 ms (Typical)	
Electrical Life (Resistive load)	V D E:	5 A @ 250 VAC 30,000ops (10 ops/minute) at 75°C
		5 A @ 30 VAC 70,000ops (10 ops/minute) at 75°C
	U L:	5 A @ 250 VAC/30 VDC 6,000 ops.
		3 A @ 250 VAC/30 VDC 100,000 ops.
Mechanical Life	20,000,000 ops at no load (300 ops/minute)	
Intra-module Isolation, Field-to-Logic	3750 VDC	
Power-on Value	Yes, Programmable	
Safe Value	Yes, Programmable	

Pin Assignments

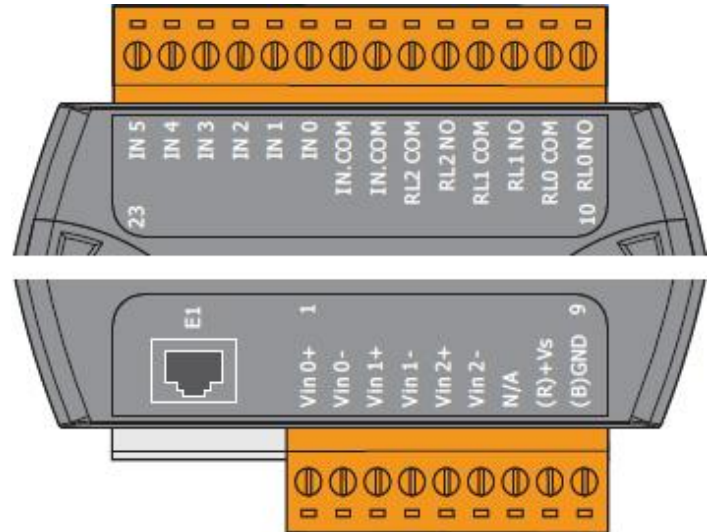

Voltage/Current Input Selection Jumper

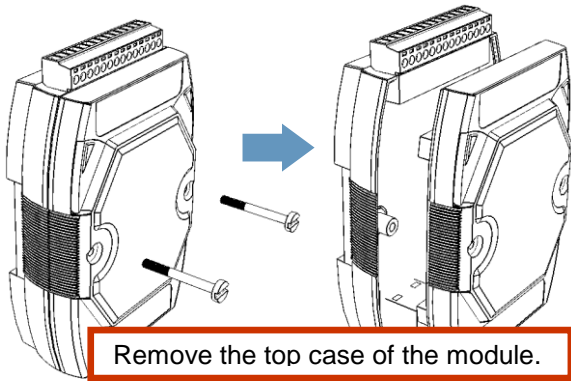

Remove the top case of the module.

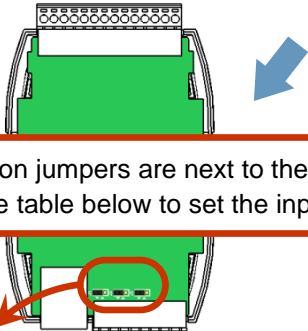

The selection jumpers are next to the connector. Refer to the table below to set the input type.

Channel	Vin0 ±	Vin1 ±	Vin2 ±
Jumper	J1	J2	J3

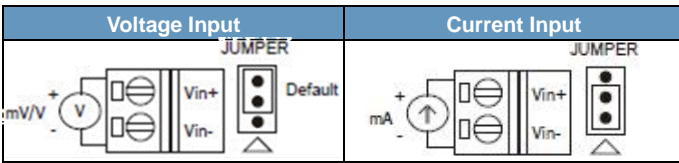

Digital Input/Counter	Readback as 1	Readback as 0
	+10 ~ +50 V _{DC}	Open or <4 V _{DC}
Sink		
Source		

Power Relay	ON State	OFF State
	Readback as 1	Readback as 0
Relay Output		

Tips & Warnings



The jumper settings of the input type for each AI channel must correspond to the input range for each AI channel of the web interface.

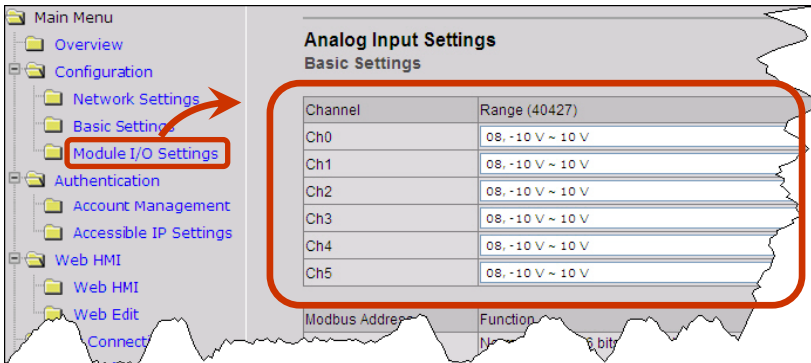

Wire Connections

ET-7000/PET-7000 Register Table, version 1.0.3

Modbus Register Table

Coils (0xxxx)

Register		Points	Description	Data Format	Attribute	Factory Default
DEC	HEX					
0000 : 0002	0000 : 0002	3	DO value	0: Off 1: On	R/W	-
00034 : 00039	0022 : 0027	6	Clear the DI counter value	1: Clear	W	-
00130 : 00135	0082 : 0087	6	Clear the DI latched value	1: Clear	W	-
00162 : 00164	00A2 : 00A4	3	Clear 1-ch historical AI max. value	1: Clear	W	-
00194 : 00196	00C2 : 00C4	3	Clear 1-ch historical AI min. value	1: Clear	W	-
00226	00E2	1	Reset the I/O settings to the factory default state	1: Reset	W	-
00233	00E9	1	Reboot the module	1: Reboot	W	-
00350	015E	1	Enable/Disable the DI latch function	0: Disable 1: Enable	R/W/E	0
00351 : 00356	015F : 0164	6	Enable/Disable the DI counter function	0: Disable 1: Enable	R/W/E	0
00431	01AF	1	Save the DO power-on value to the EEPROM	1: Save	W/E	-
00432	01B0	1	Save the DO safe value to the EEPROM	1: Save	W/E	-
00435 : 00437	01B3 : 01B5	3	Enable/Disable the DO power-on value function	0: Disable 1: Enable	R/W	0
00515 : 00517	0203 : 0205	3	Enable/Disable the DO safe value function	0: Disable 1: Enable	R/W	0
00595 : 00597	0253 : 0255	3	Enable/Disable the AI function	0: Disable 1: Enable	R/W/E	1
00628	0274	1	Set the AI sampling rate	0: Normal mode (10 Hz, 16 bits) 1: Fast mode (60 Hz, 12 bits)	R/W/E	0
00629	0275	1	Set the AI noise filter	0: Frequency 60 Hz 1: Frequency 50 Hz	R/W/E	0
00630	0276	1	Save preset values for the DI counter to the EEPROM	1: Save	W/E	-
00631	0277	1	Set the AI data format	0: Hexadecimal format 1: Engineering unit	R/W/E	0
00632	0278	1	Reset the AI calibration to the factory settings	1: Reset	W	-
00634	027A	1	Clear all historical AI max. values	1: Clear	W	-
00635	027B	1	Clear all historical AI min. values	1: Clear	W	-
00636 : 00638	027C : 027E	3	Enable/Disable the AI high alarm function	0: Disable 1: Enable	R/W/E	0
00668 : :	029C : :	3	Enable/Disable the AI low alarm function	0: Disable 1: Enable	R/W/E	0

ET-7000/PET-7000 Register Table, version 1.0.3

00670	029E					
00700 : 00702	02BC : 02BE	3	Set the AI high alarm mode	0: Momentary mode 1: Latching mode	R/W/E	0
00732 : 00734	02DC : 02DE	3	Set the AI low alarm mode	0: Momentary mode 1: Latching mode	R/W/E	0
00764 : 00766	02FC : 02FE	3	Clear the AI high alarm status	1: Clear	W	-
00796 : 00798	031C : 031E	3	Clear the AI low alarm status	1: Clear	W	-
00830	033E	1	Enable/Disable the AI calibration	0: Disable 1: Enable	R/W	-
00831	033F	1	Zero calibration for the channel 0	1: Set	W	-
00832	0340	1	Span calibration for the channel 0	1: Set	W	-

Discrete Inputs (1xxxx)

Register		Points	Description	Data Format	Attribute
DEC	HEX				
10000 : 10005	0000 : 0005	6	DI value	0: Off 1: On	R
10032 : 10037	0020 : 0025	6	Read DI "high latch" status	0: Normal 1: Latched	R
10064 : 10069	0040 : 0045	6	Read DI "low latch" status	0: Normal 1: Latched	R
10224 : 10226	00E0 : 00E2	3	Read AI high alarm status. When the AI value is higher than the high alarm value, the status becomes 1.	0: Normal 1: Alarmed	R
10256 : 10258	0100 : 0102	3	Read AI low alarm status. When the AI value is lower than the high alarm value, the status becomes 1.	0: Normal 1: Alarmed	R

Input Register (3xxxx)

Register		Points	No. Per Point	Description	Data Format	Attribute
DEC	HEX					
30000 : 30002	0000 : 0002	3	1	AI value	-32768 to 32767 (0x0000 to 0xFFFF)	R
30032 : 30043	0020 : 002B	6	2	DI counter value	0 to 4294967295	R
30236 : 30238	00EC : 00EE	3	1	AI historical max. value	-32768 to 32767 (0x0000 to 0xFFFF)	R
30268 : 30270	010C : 010E	3	1	AI historical min. value	-32768 to 32767 (0x0000 to 0xFFFF)	R
30300	012C	1	1	Number of the DI channel	6	R
30310	0136	1	1	Number of the DO channel	3	R
30320	0140	1	1	Number of the AI channel	3	R
30350	015E	1	1	OS image version	0x123 means version 1.2.3	R
30351	015F	1	1	Firmware version	0x123 means version 1.2.3	R
30353	0161	1	1	I/O version	0x123 means version 1.2.3	R
30360	0168	1	1	Communication state of the pair-connection	0: Normal <0: Failed	R

Holding Register (4xxxx)

Register		Points	No. Per Point	Description	Data Format	Attribute	Factory Value
DEC	HEX						
40200 : 40211	00C8 : 00D3	6	2	Set a preset value for the DI Counter Any values updated based on the Modbus communication will not take immediate effect and not be saved to EEPROM until the register (00630) is changed by a write operation.	0 to 4294967295	R/W	0
40271	010F	1	1	Set the module identification (Modbus NetID)	1 to 255	R/W/E	1
40296 : 40298	0128 : 012A	3	1	Set the AI high alarm value	-32768 to 32767 (0x0000 to 0xFFFF)	R/W/E	32767 (0x7FFF)
40328 : 40330	0148 : 014A	3	1	Set the AI low alarm value	-32768 to 32767 (0x0000 to 0xFFFF)	R/W/E	-32768 (0x8000)
40427 : 40429	01AB : 01AD	3	1	Set the AI range	0x07: 4~20 mA 0x08: +/-10 V 0x09: +/-5 V 0x0A: +/-1 V 0x0B: +/-500 mV 0x0C: +/-150 mV 0x0D: +/-20 mA 0x1A: 0~20 mA	R/W/E	0x08
40555	022B	1	1	Read the module reset status	1: Power-on 2: Module Watchdog 3: Software Reset Command	R	-
40556	022C	1	1	Read the boot count of the module The factory default value is 0 when the settings are set to the factory default values.	1 to 32767	R	-
40557	022D	1	1	Set the Host WDT timeout (unit: second)	0: Disable the Host WDT 5 to 65535: Enable the Host WDT	R/W/E	0
40558	022E	1	1	Read the WDT event count The initial value is 0 when the module is reset, and is increased when the WDT even happens.	0 to 32767	R	-
40559	022F	1	1	Read the module name	0x7002	R	-

ET-7005/PET-7005

I/O Specifications

Thermistor Input	
Input Channels	8 (Differential)
Sensor Type	Precon ST-A3, Fenwell U, YSI L100, YSI L300, YSI L1000, YSI B2252, YSI B3000, YSI B5000, YSI B6000, YSI B10000, YSI H10000, YSI H30000, User-defined
Individual Channel Configuration	Yes
Resolution	16-bit
Sampling Rate	10 Samples/Sec. (Total)
Accuracy	+/-0.1% or better
Zero Drift	+/-20 μ V/ $^{\circ}$ C
Span Drift	+/-25 ppm/ $^{\circ}$ C
Over voltage Protection	110 VDC/VAC
Common Mode Rejection	86 dB
Normal Mode Rejection	100 dB
Open Wire Detection	Yes
Digital Output	
Output Channels	4
Type	Isolated Open Collector (Sink)
Max. Load Current	700 mA/Channel
Load Voltage	5 VDC ~ 50 VDC
Overvoltage Protection	60 VDC
Overload Protection	1.4 A
Short-circuit Protection	Yes
Power-on Value	Yes, Programmable
Safe Value	Yes, Programmable

Pin Assignments

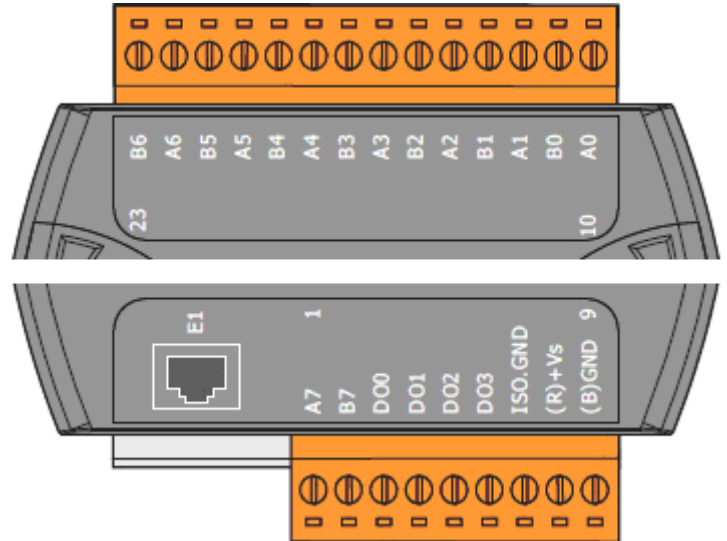

Wire Connections

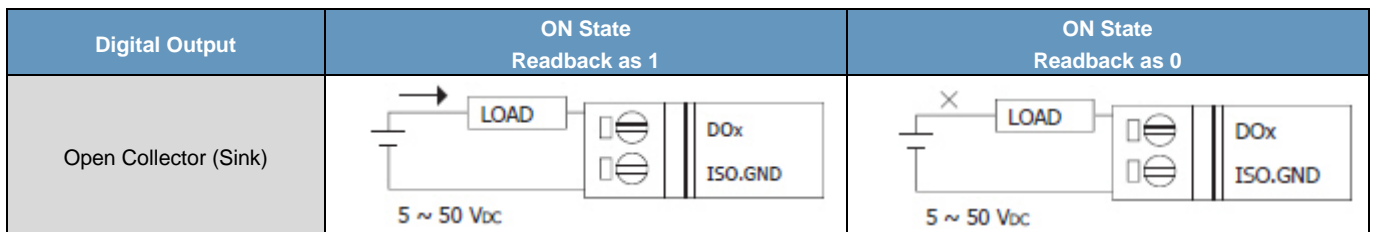
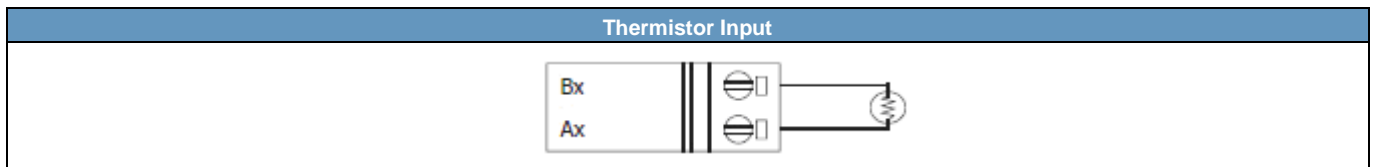

Modbus Register Table

Coils (0xxxx)

Register		Points	Description	Data Format	Attribute	Factory Value
DEC	HEX					
0000 : 0003	0000 : 0003	4	DO value	0: Off 1: On	R/W	-
00162 : 00169	00A2 : 00A9	8	Clear 1-ch historical AI max. value	1: Clear	W	-
00194 : 00201	00C2 : 00C9	8	Clear 1-ch historical AI min. value	1: Clear	W	-
00226	00E2	1	Reset the I/O settings to the factory default state	1: Reset	W	-
00233	00E9	1	Reboot module	1: Reboot	W	-
00431	01AF	1	Save the DO power-on value to the EEPROM	1: Save	W/E	-
00432	01B0	1	Save the DO safe value to the EEPROM	1: Save	W/E	-
00435 : 00438	01B3 : 01B6	4	Enable/Disable the DO power-on value function	0: Disable 1: Enable	R/W	0
00515 : 00518	0203 : 0206	4	Enable/Disable the DO safe value function	0: Disable 1: Enable	R/W	0
00595 : 00602	0253 : 025A	8	Enable/Disable the AI function	0: Disable 1: Enable	R/W/E	1
00627	0273	1	Set the temperature scale	0: Celsius 1: Fahrenheit	R/W/E	0
00631	0277	1	Set the AI data format	0: Hexadecimal format 1: Engineering unit	R/W/E	0
00632	0278	1	Reset the AI calibration to the factory settings	1: Reset	W	-
00634	027A	1	Clear all historical AI max. values	1: Clear	W	-
00635	027B	1	Clear all historical AI min. values	1: Clear	W	-
00636 : 00643	027C : 0283	8	Enable/Disable the AI high alarm function	0: Disable 1: Enable	R/W/E	0
00668 : 00675	029C : 02A3	8	Enable/Disable the AI low alarm function	0: Disable 1: Enable	R/W/E	0
00700 : 00707	02BC : 02C3	8	Set the AI high alarm mode	0: Momentary mode 1: Latching mode	R/W/E	0
00732 : 00739	02DC : 02E3	8	Set the AI low alarm mode	0: Momentary mode 1: Latching mode	R/W/E	0
00764 : 00771	02FC : 0303	8	Clear the AI high alarm status	1: Clear	W	-
00796 : 00803	031C : 0323	8	Clear the AI low alarm status	1: Clear	W	-
00830	033E	1	Enable/Disable the AI calibration	0: Disable 1: Enable	R/W	-
00831	033F	1	Zero calibration for the channel 0	1: Active	W	-
00832	0340	1	Span calibration for the channel 0	1: Active	W	-

ET-7000/PET-7000 Register Table, version 1.0.3

Discrete Inputs (1xxxx)

Register		Points	Description	Data Format	Attribute
DEC	HEX				
10224 :	00E0 :	8	Read AI high alarm status. When the AI value is higher than the high alarm value, the status becomes 1.	0: Normal 1: Alarmed	R
10231	00E7				
10256 :	0100 :	8	Read AI low alarm status. When the AI value is lower than the high alarm value, the status becomes 1.	0: Normal 1: Alarmed	R
10263	0107				

Input Register (3xxxx)

Register		Points	No. Per Point	Description	Data Format	Attribute
DEC	HEX					
30000 :	0000 :	8	1	AI value	-32768 to 32767 (0x0000 to 0xFFFF)	R
30007	0007					
30236 :	00EC :	8	1	AI historical max. value	-32768 to 32767 (0x0000 to 0xFFFF)	R
30243	00F3					
30268 :	010C :	8	1	AI historical min. value	-32768 to 32767 (0x0000 to 0xFFFF)	R
30275	0113					
30310	0136	1	1	Number of the DO channel	4	R
30320	0140	1	1	Number of the AI channel	8	R
30350	015E	1	1	OS image version	0x123 means version 1.2.3	R
30351	015F	1	1	Firmware version	0x123 means version 1.2.3	R
30353	0161	1	1	I/O version	0x123 means version 1.2.3	R
30360	0168	1	1	Communication state of the pair-connection	0: Normal <0: Failed	R

Holding Register (4xxxx)

Register		Points	No. Per Point	Description	Data Format	Attribute	Factory Value
DEC	HEX						
40110 : 40117	006E : 0075	8	1	Set the AI temperature offset value	-128 to 127	R/W/E	0
40271	010F	1	1	Set the module identification (Modbus NetID)	1 to 255	R/W/E	1
40296 : 40303	0128 : 012F	8	1	Set the AI high alarm value	-32768 to 32767 (0x0000 to 0xFFFF)	R/W/E	32767 (0x7FFF)
40328 : 40335	0148 : 014F	8	1	Set the AI low alarm value	-32768 to 32767 (0x0000 to 0xFFFF)	R/W/E	-4096 (0xF000)
40427 : 40434	01AB : 01B2	8	1	Set the AI range	0x60: PreCon Type III 10K@25°C, -30°F ~ 240°F 0x61: Fenwell Type U 2K@25°C, -50°C ~ 150°C 0x62: Fenwell Type U 2K@25°C, 0°C ~ 150°C 0x63: YSI L Mix 100@25°C, -80°C ~ 100°C 0x64: YSI L Mix 300@25°C, -80°C ~ 100°C 0x65: YSI L Mix 1000@25°C, -70°C ~ 100°C 0x66: YSI B Mix 2252@25°C, -50°C ~ 150°C 0x67: YSI B Mix 3000@25°C, -40°C ~ 150°C 0x68: YSI B Mix 5000@25°C, -40°C ~ 150°C 0x69: YSI B Mix 6000@25°C, -30°C ~ 150°C 0x6A: YSI B Mix 10000@25°C, -30°C ~ 150°C 0x6B: YSI B Mix 10000@25°C, -30°C ~ 150°C 0x6C: YSI B Mix 30000@25°C, -10°C ~ 200°C 0x70 to 0x77: User-defined, -50°C ~ 150°C	R/W/E	0x60
40555	022B	1	1	Read the module reset status	1: Power-on 2: Module Watchdog 3: Software Reset Command	R	-
40556	022C	1	1	Read the boot count of the module The factory default value is 0 when the settings are set to the factory default values.	1 to 32767	R	-
40557	022D	1	1	Set the Host WDT timeout (unit: second)	0: Disable the Host WDT 5 to 65535: Enable the Host WDT	R/W/E	0
40558	022E	1	1	Read the WDT event count The initial value is 0 when the module is reset, and is increased when the WDT even happens.	0 to 32767	R	-
40559	022F	1	1	Read the module name	0x7005	R	-
40590 : 40597	024E : 0255	8	1	Set the AI Steinhart-hart coefficient A	Steinhart-hart coefficient in IEEE-754 format	R/W/E	0
40622 : 40629	026E : 0275	8	1	Set the AI Steinhart-hart coefficient B	Steinhart-hart coefficient in IEEE-754 format	R/W/E	0
40654 : 40661	028E : 0295	8	1	Set the AI Steinhart-hart coefficient C	Steinhart-hart coefficient in IEEE-754 format	R/W/E	0

ET-7015/PET-7015

I/O Specifications

RTD Input	
Input Channels	7 (Differential)
Sensor Type	Pt100, Pt1000, Ni120, Cu100, Cu1000
Wire Connection	2/3 wire
Individual Channel Configuration	Yes
Resolution	16-bit
Sampling Rate	12 Samples/Sec. (Total)
Accuracy	+/-0.05%
Zero Drift	+/-0.5 μ V/ $^{\circ}$ C
Span Drift	+/-20 μ V/ $^{\circ}$ C
Common Mode Rejection	150 dB
Normal Mode Rejection	100 dB
Input Impedance	>1 M Ω
Open Wire Detection	Yes
3-wire RTD Lead Resistance Elimination	Yes

Pin Assignments

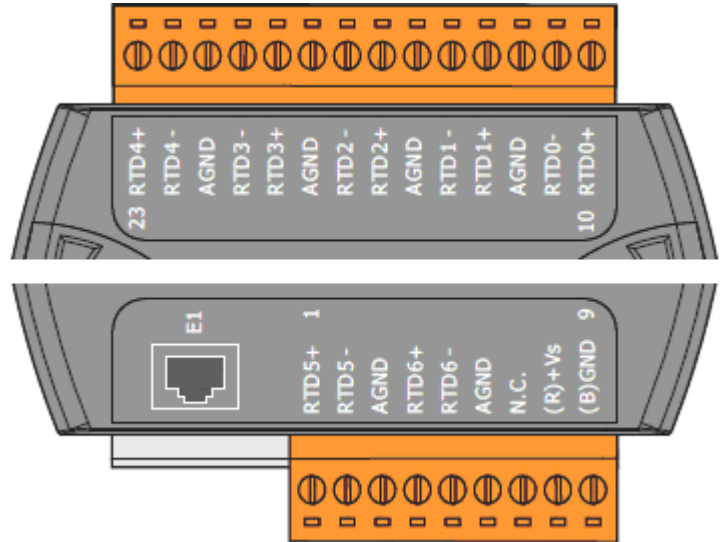

Wire Connections

RTD Input	CH0 1, 2, 5 and 6	CH3 and CH4
2-wire of RTD		
3-wire of RTD		

Tips & Warnings

- Use 26-12 AWG wire for signal connections
- Strip the wire to a length of 7 ± 0.5 mm
- Use a crimp terminal for wiring
- Avoid high-voltage cables and power equipment as much as possible
- Use shielded wire and connect the shielding to the Ax terminal of the channel

Modbus Register Table

Coils (0xxxx)

Register		Points	Description	Data Format	Attribute	Factory Value
DEC	HEX					
00226	00E2	1	Reset the I/O settings to the factory default state	1: Reset	W	-
00233	00E9	1	Reboot the module	1: Reboot	W	-
00595 : 00601	0253 : 0259	7	Enable/Disable the AI function	0: Disable 1: Enable	R/W/E	1
00629	0275	1	Set the AI noise filter	0: Frequency 60 Hz 1: Frequency: 50 Hz	R/W/E	0
00631	0277	1	Set the AI data format	0: Hexadecimal format 1: Engineering unit	R/W/E	0
00632	0278	1	Reset the AI calibration to the factory settings	1: Reset	W	-
00830	033E	1	Enable/Disable the AI calibration	0: Disable 1: Enable	R/W	-
00831	033F	1	Zero calibration for the channel 0	1: Set	W	-
00832	0340	1	Span calibration for the channel 0	1: Set	W	-
00833	0341	1	Zero calibration for the channel 1	1: Set	W	-
00834	0342	1	Span calibration for the channel 1	1: Set	W	-
00835	0343	1	Zero calibration for the channel 2	1: Set	W	-
00836	0344	1	Span calibration for the channel 2	1: Set	W	-
00837	0345	1	Zero calibration for the channel 3	1: Set	W	-
00838	0346	1	Span calibration for the channel 3	1: Set	W	-
00839	0347	1	Zero calibration for the channel 4	1: Set	W	-
00840	0348	1	Span calibration for the channel 4	1: Set	W	-
00841	0349	1	Zero calibration for the channel 5	1: Set	W	-
00842	034A	1	Span calibration for the channel 5	1: Set	W	-
00843	034B	1	Zero calibration for the channel 6	1: Set	W	-
00844	034C	1	Span calibration for the channel 6	1: Set	W	-

Input Register (3xxxx)

Register		Points	No. Per Point	Description	Data Format	Attribute
DEC	HEX					
30000 : 30006	0000 : 0006	7	1	AI value	-32768 to 32767 (0x0000 to 0xFFFF)	R
30320	0140	1	1	Number of the AI channel	7	R
30350	015E	1	1	OS image version	0x123 means version 1.2.3	R
30351	015F	1	1	Firmware version	0x123 means version 1.2.3	R
30353	0161	1	1	I/O version	0x123 means version 1.2.3	R

Holding Register (4xxxx)

Register		Points	No. Per Point	Description	Data Format	Attribute	Factory Value
DEC	HEX						
40110 :	006E :	7	1	Set the AI temperature offset value	-128 to 127	R/W/E	0
40116	0074						
40142 :	008E :	7	1	Set the AI resistance offset value	0 to 255	R/W/E	0
40148	0094						
40271	010F	1	1	Set the module identification (Modbus NetID)	1 to 255	R/W/E	1
40427 :	01AB :	7	1	Set the AI range	0x20: Platinum 100, $\alpha=0.00385$, $-100^{\circ}\text{C} \sim 100^{\circ}\text{C}$ 0x21: Platinum 100, $\alpha=0.00385$, $0^{\circ}\text{C} \sim 100^{\circ}\text{C}$ 0x22: Platinum 100, $\alpha=0.00385$, $0^{\circ}\text{C} \sim 200^{\circ}\text{C}$ 0x23: Platinum 100, $\alpha=0.00385$, $0^{\circ}\text{C} \sim 600^{\circ}\text{C}$ 0x24: Platinum 100, $\alpha=0.003916$, $-100^{\circ}\text{C} \sim 100^{\circ}\text{C}$ 0x25: Platinum 100, $\alpha=0.003916$, $0^{\circ}\text{C} \sim 100^{\circ}\text{C}$ 0x26: Platinum 100, $\alpha=0.003916$, $0^{\circ}\text{C} \sim 200^{\circ}\text{C}$ 0x27: Platinum 100, $\alpha=0.003916$, $0^{\circ}\text{C} \sim 600^{\circ}\text{C}$ 0x28: Nickel 120, $-80^{\circ}\text{C} \sim 100^{\circ}\text{C}$ 0x29: Nickel 120, $0^{\circ}\text{C} \sim 100^{\circ}\text{C}$ 0x2A: Platinum 1000, $\alpha=0.00385$, $-200^{\circ}\text{C} \sim 600^{\circ}\text{C}$ 0x2B: Cu 100 @ 0°C , $\alpha=0.00421$, $-20^{\circ}\text{C} \sim 150^{\circ}\text{C}$ 0x2C: Cu 100 @ 25°C , $\alpha=0.00427$, $0^{\circ}\text{C} \sim 200^{\circ}\text{C}$ 0x2D: Cu 1000 @ 0°C , $\alpha=0.00421$, $-20^{\circ}\text{C} \sim 150^{\circ}\text{C}$ 0x2E: Platinum 100, $\alpha=0.00385$, $-200^{\circ}\text{C} \sim 200^{\circ}\text{C}$ 0x2F: Platinum 100, $\alpha=0.003916$, $-200^{\circ}\text{C} \sim 200^{\circ}\text{C}$ 0x80: Platinum 100, $\alpha=0.00385$, $-200^{\circ}\text{C} \sim 600^{\circ}\text{C}$ 0x81: Platinum 100, $\alpha=0.003916$, $-200^{\circ}\text{C} \sim 600^{\circ}\text{C}$ 0x82: Cu 50 @ 0°C , $-50^{\circ}\text{C} \sim 150^{\circ}\text{C}$ 0x83: Nickel 100, $-60^{\circ}\text{C} \sim 180^{\circ}\text{C}$	R/W/E	0x20
40433	01B1						
40555	022B	1	1	Read the module reset status	1: Power-on 2: Module Watchdog 3: Software Reset Command	R	-
40556	022C	1	1	Read the boot count of the module The factory default value is 0 when the settings are set to the factory default values.	1 to 32767	R	-
40557	022D	1	1	Set the Host WDT timeout (unit: second)	0: Disable the Host WDT 5 to 65535: Enable the Host WDT	R/W/E	0
40558	022E	1	1	Read the WDT event count The initial value is 0 when the module is reset, and is increased when the WDT even happens.	0 to 32767	R	-
40559	022F	1	1	Read the module name	0x7015	R	-

ET-7016/PET-7016

I/O Specifications

Strain Gauge Input		
Input Channels	2 (Differential)	
Input Type	+/-15 mV, +/-50 mV, +/-100 mV, +/-500 mV, +/-1 V, +/-2.5 V, 0~20 mA, +/-20 mA, 4~20 mA	
Strain Gauge Type	Full-Bridge, Half-Bridge and Quarter-Bridge	
Individual Channel Configuration	Yes	
Resolution	16-bit	
Sampling Rate	10 Samples/Sec. (Total)	
Accuracy	+/-0.05%	
Zero Drift	+/-0.5 uV/°C	
Span Drift	+/-25 ppm/°C	
Over voltage Protection	30 VDC	
Input Impedance	Voltage	>400 kΩ
	Current	124 Ω
Common Mode Rejection	150 dB Min.	
Normal Mode Rejection	100 dB	
Excitation Voltage Output		
Output Channels	1	
Output Range	0 ~ 10V	
Max. Output Load Current	60 mA	
Accuracy	+/-0.05% of FSR	
Drift	+/-50 ppm/°C	
Power-on Value	Yes	
Digital Input/Counter		
Input Channels	2	
Type	Wet Contact (Sink or Source)	
On Voltage Level	+3.5 VDC ~ +50 VDC	
Off Voltage Level	+1V VDC Max.	
Input Impedance	10 KΩ, 0.5W	
Counter	Channels	2
	Max. Count	4,294,967,285 (32-bit)
	Max. Input Frequency	100 Hz
	Min. Pulse Width	5 ms
Overvoltage Protection	+70 VDC	
Digital Output		
Output Channels	2	
Type	Isolated Open Collector (Sink)	
Max. Load Current	700 mA/Channel	
Load Voltage	5 VDC ~ 50 VDC	
Overvoltage Protection	60 VDC	
Overload Protection	1.4 A	
Short-circuit Protection	Yes	
Power-on Value	Yes, Programmable	
Safe Value	Yes, Programmable	

Pin Assignments

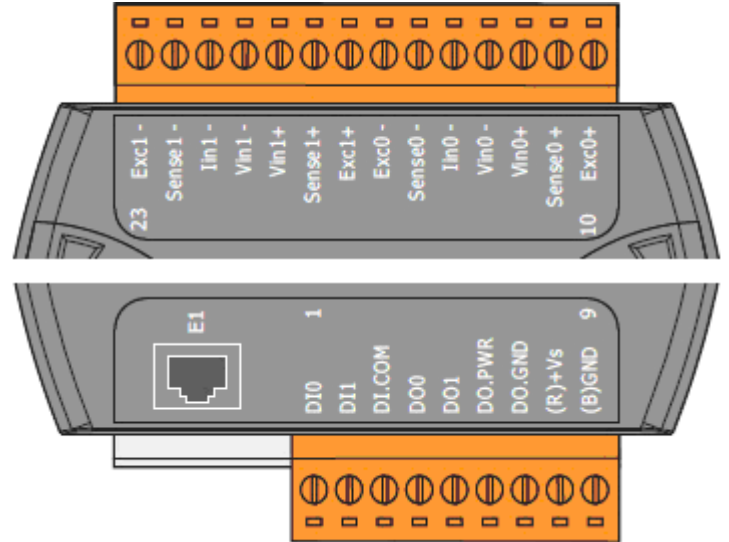

Excitation Voltage

Strain Gauge	Quarter-Bridge	Half-Bridge	Full-Bridge
120R	7.0V	7.0V	3.5V
350R	10V	10V	10V

Wire Connections

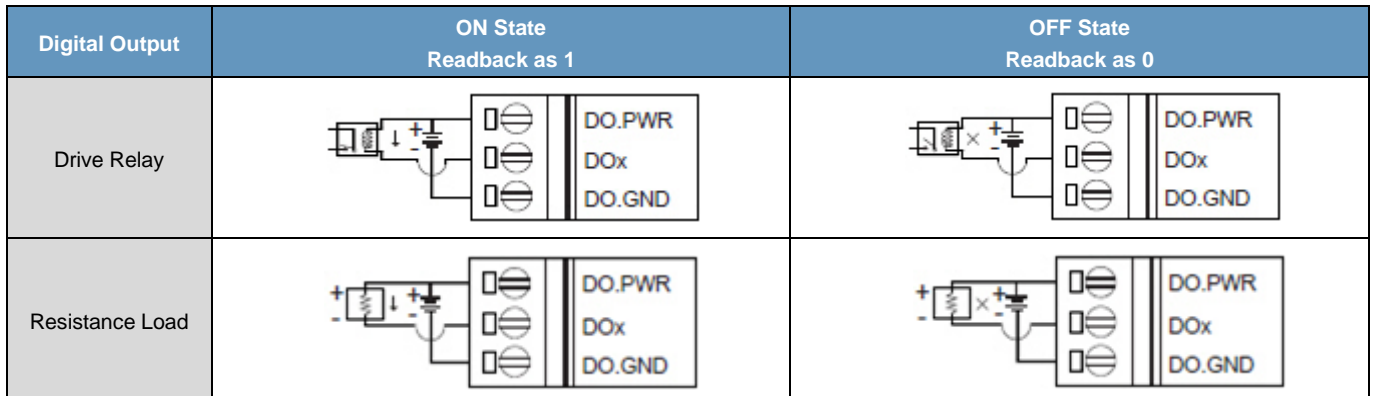
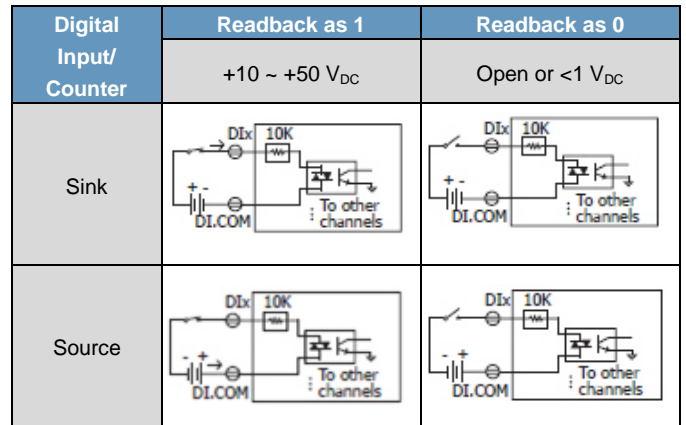
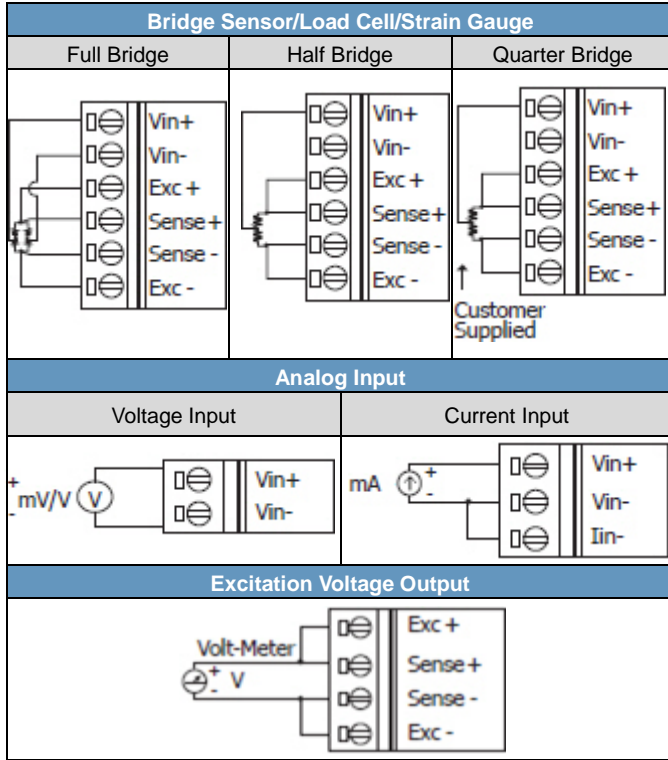

Modbus Register Table

Coils (0xxxx)

Register		Points	Description	Data Format	Attribute	Factory Default
DEC	HEX					
0000 : 0001	0000 : 0001	2	DO value	0: Off 1: On	R/W	-
00034 : 00035	0022 : 0023	2	Clear the DI counter value	1: Clear	W	-
00130 : 00131	0082 : 0083	2	Clear the DI latched value	1: Clear	W	-
00162 : 00163	00A2 : 00A3	2	Clear 1-ch historical AI max. value	1: Clear	W	-
00194 : 00195	00C2 : 00C3	2	Clear 1-ch historical AI min. value	1: Clear	W	-
00226	00E2	1	Reset the I/O settings to the factory default state	1: Reset	W	-
00233	00E9	1	Reboot the module	1: Reboot	W	-
00341 : 00342	0155 : 0156	2	Set the strain gauge input type	0: Half-bridge/Quarter-bridge 1: Full-bridge	R/W/E	0
00343 : 00344	0157 : 0158	2	Enable/Disable the start-up voltage output	0: Disable 1: Enable	R/W/E	0
00345 : 00346	0159 : 016A	2	Enable/Disable the linear mapping	0: Disable 1: Enable	R/W/E	0
00350	015E	1	Enable/Disable the DI latch function	0: Disable 1: Enable	R/W/E	0
00351 : 00352	015F : 0160	2	Enable/Disable the DI counter function	0: Disable 1: Enable	R/W/E	0
00431	01AF	1	Save the DO power-on value to the EEPROM	1: Save	W/E	-
00432	01B0	1	Save the DO safe value to the EEPROM	1: Save	W/E	-
00435 : 00436	01B3 : 01B4	2	Enable/Disable the DO power-on value function	0: Disable 1: Enable	R/W	0
00515 : 00516	0203 : 0204	2	Enable/Disable the DO safe value function	0: Disable 1: Enable	R/W	0
00595 : 00596	0253 : 0254	2	Enable/Disable the AI function	0: Disable 1: Enable	R/W/E	1
00629	0275	1	Set the AI noise filter	0: Frequency 60 Hz 1: Frequency 50 Hz	R/W/E	0
00630	0276	1	Save preset values for the DI counter to the EEPROM	1: Save	W/E	-
00631	0277	1	Set the AI/AO data format	0: Hexadecimal format 1: Engineering unit	R/W/E	0
00632	0278	1	Reset the AI calibration to the factory settings	1: Reset	W	-
00634	027A	1	Clear all historical AI max. values	1: Clear	W	-

ET-7000/PET-7000 Register Table, version 1.0.3

00635	027B	1	Clear all historical AI min. values	1: Clear	W	-
00636	027C	2	Enable/Disable the AI high alarm function	0: Disable 1: Enable	R/W/E	0
:	:					
00637	027D					
00668	029C	2	Enable/Disable the AI low alarm function	0: Disable 1: Enable	R/W/E	0
:	:					
00669	029D					
00700	02BC	2	Set the AI high alarm mode	0: Momentary mode 1: Latching mode	R/W/E	0
:	:					
00701	02BD					
00732	02DC	2	Set the AI low alarm mode	0: Momentary mode 1: Latching mode	R/W/E	0
:	:					
00733	02DD					
00764	02FC	2	Clear the AI high alarm status	1: Clear	W	-
:	:					
00765	02FD					
00796	031C	2	Clear the AI low alarm status	1: Clear	W	-
:	:					
00797	031D					
00830	033E	1	Enable/Disable the AI calibration	0: Disable 1: Enable	R/W	-
00831	033F	1	Zero calibration for the channel 0	1: Set	W	-
00832	0340	1	Span calibration for the channel 0	1: Set	W	-

Discrete Inputs (1xxxx)

Register		Points	Description	Data Format	Attribute
DEC	HEX				
10000	0000	2	DI value	0: Off 1: On	R
:	:				
10001	0001				
10032	0020	2	Read DI "high latch" status	0: Normal 1: Latched	R
:	:				
10033	0021				
10064	0040	2	Read DI "low latch" status	0: Normal 1: Latched	R
:	:				
10065	0041				
10224	00E0	2	Read AI high alarm status. When the AI value is higher than the high alarm value, the status becomes 1.	0: Normal 1: Alarmed	R
:	:				
10225	00E1				
10256	0100	2	Read AI low alarm status. When the AI value is lower than the high alarm value, the status becomes 1.	0: Normal 1: Alarmed	R
:	:				
10257	0101				

Input Register (3xxxx)

Register		Points	No. Per Point	Description	Data Format	Attribute
DEC	HEX					
30000 : 30001	0000 : 0001	2	1	AI value	-32768 to 32767 (0x0000 to 0xFFFF)	R
30032 : 30035	0020 : 0023	2	2	DI counter value	0 to 4294967295	R
30236 : 30237	00EC : 00ED	2	1	AI historical max. value	-32768 to 32767 (0x0000 to 0xFFFF)	R
30268 : 30269	010C : 010D	2	1	AI historical min. value	-32768 to 32767 (0x0000 to 0xFFFF)	R
30300	012C	1	1	Number of the DI channel	6	R
30310	0136	1	1	Number of the DO channel	3	R
30320	0140	1	1	Number of the AI channel	3	R
30350	015E	1	1	OS image version	0x123 means version 1.2.3	R
30351	015F	1	1	Firmware version	0x123 means version 1.2.3	R
30353	0161	1	1	I/O version	0x123 means version 1.2.3	R
30360	0168	1	1	Communication state of the pair-connection	0: Normal <0: Failed	R

Holding Register (4xxxx)

Register		Points	No. Per Point	Description	Data Format	Attribute	Factory Value
DEC	HEX						
40000 : 40001	0000 : 0001	2	1	Set the excitation voltage output	-32768 to 32767 (0x0000 to 0xFFFF)	R/W	-
40200 : 40203	00C8 : 00CB	2	2	Set a preset value for the DI Counter Any values updated based on the Modbus communication will not take immediate effect and not be saved to EEPROM until the register (00630) is changed by a write operation.	0 to 4294967295	R/W	0
40271	010F	1	1	Set the module identification (Modbus NetID)	1 to 255	R/W/E	1
40296 : 40297	0128 : 0129	2	1	Set the AI high alarm value	-32768 to 32767 (0x0000 to 0xFFFF)	R/W/E	32767 (0x7FFF)
40328 : 40329	0148 : 0149	2	1	Set the AI low alarm value	-32768 to 32767 (0x0000 to 0xFFFF)	R/W/E	-32768 (0x8000)
40360 : 40361	0168 : 0169	2	1	Set the start-up excitation voltage	-32768 to 32767 (0x0000 to 0xFFFF)	R/W/E	0
40427 : 40428	01AB : 01AC	2	1	Set the strain gauge input range	0x00: +/-15 mV 0x01: +/-50 mV 0x02: +/-100 mV 0x03: +/-500 mV 0x04: +/-1 V 0x05: +/-2.5 V 0x06: +/-20 mA 0x07: 4 ~ 20 mA 0x1A: 0 ~ 20 mA	R/W/E	0x05
40461	01CD	1	1	Set the source low value for the channel 0	-32768 to 32767 (0x0000 to 0xFFFF)	R/W/E	0
40462	01CE	1	1	Set the source high value for the channel 0	-32768 to 32767 (0x0000 to 0xFFFF)	R/W/E	0
40463	01CF	1	1	Set the target low value for the channel 0	-32768 to 32767 (0x0000 to 0xFFFF)	R/W/E	0
40464	01D0	1	1	Set the target high value for the channel 0	-32768 to 32767 (0x0000 to 0xFFFF)	R/W/E	0
40465	01D1	1	1	Set the source low value for the channel 1	-32768 to 32767 (0x0000 to 0xFFFF)	R/W/E	0
40466	01D2	1	1	Set the source high value for the channel 1	-32768 to 32767 (0x0000 to 0xFFFF)	R/W/E	0
40467	01D3	1	1	Set the target low value for the channel 1	-32768 to 32767 (0x0000 to 0xFFFF)	R/W/E	0
40468	01D4	1	1	Set the target high value for the channel 1	-32768 to 32767 (0x0000 to 0xFFFF)	R/W/E	0
40555	022B	1	1	Read the module reset status	1: Power-on 2: Module Watchdog 3: Software Reset Command	R	-
40556	022C	1	1	Read the boot count of the module The factory default value is 0 when the settings are set to the factory default values.	1 to 32767	R	-
40557	022D	1	1	Set the Host WDT timeout (unit: second)	0: Disable the Host WDT 5 to 65535: Enable the Host	R/W/E	0

ET-7000/PET-7000 Register Table, version 1.0.3

					WDT		
40558	022E	1	1	Read the WDT event count The initial value is 0 when the module is reset, and is increased when the WDT even happens.	0 to 32767	R	-
40559	022F	1	1	Read the module name	0x7016	R	-

ET-7017/PET-7017

I/O Specifications

Analog Input		
Input Channels	8 (Differential)	
Input Type	+/-150 mV, +/-500 mV, +/-1 V, +/-5 V, +/-10 V, 0~20 mA, +/-20 mA, 4~20 mA (jumper selectable)	
Individual Channel Configuration	Yes	
Resolution	Normal Mode	16-bit
	Fast Mode	12-bit
Sampling Rate	Normal Mode	10 Samples/Sec. (Total)
	Fast Mode	60 Samples/Sec. (Total)
Accuracy	Normal Mode	+/-0.1%
	Fast Mode	+/-0.5% or better
Zero Drift	+/-20 uV/°C	
Span Drift	+/-25 ppm/°C	
Overvoltage Protection	240 Vrms	
Input Impedance	Voltage	2 MΩ
	Current	125 Ω
Common Mode Rejection	86 dB Min.	
Normal Mode Rejection	100 dB	
Digital Output		
Output Channels	4	
Type	Isolated Open Collector (Sink)	
Max. Load Current	700 mA/Channel	
Load Voltage	5 VDC~50 VDC	
Overvoltage Protection	60 VDC	
Overload Protection	1.4 A	
Short-circuit Protection	Yes	
Power-on Value	Yes, Programmable	
Safe Value	Yes, Programmable	

Pin Assignments

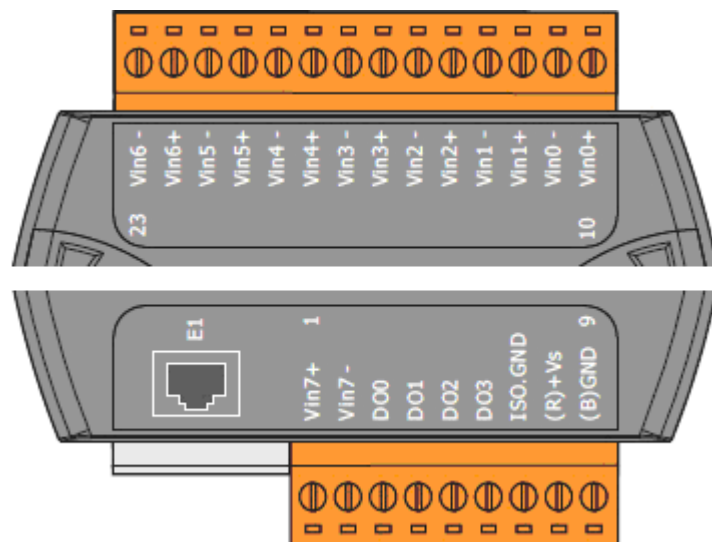

Voltage/Current Input Selection Jumper Settings

Channel	Vin6 ±	Vin5 ±	Vin4 ±	Vin3 ±	Vin2 ±	Vin1 ±	Vin0 ±
Jumper	J7	J6	J5	J4	J3	J2	J1

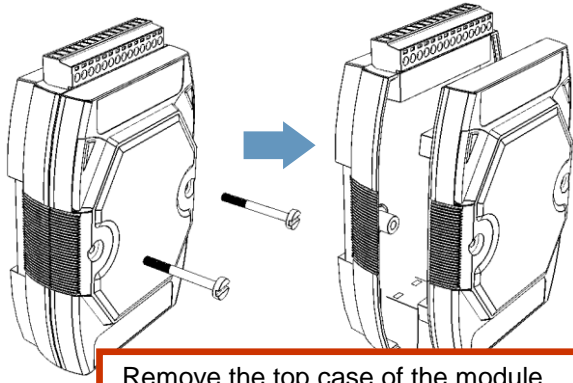

Remove the top case of the module.

The selection jumpers are next to the connector. Refer to the table below to set the input type.

Channel	Vin7 ±
Jumper	J8

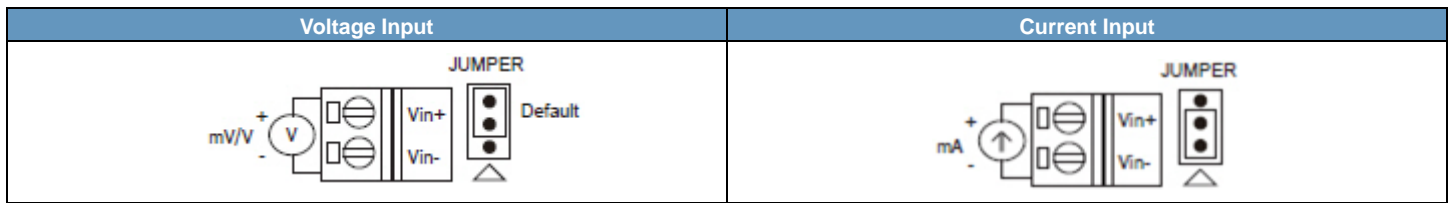

Tips & Warnings



The jumper settings of the input type for each AI channel must correspond to the input range for each AI channel of the web interface.

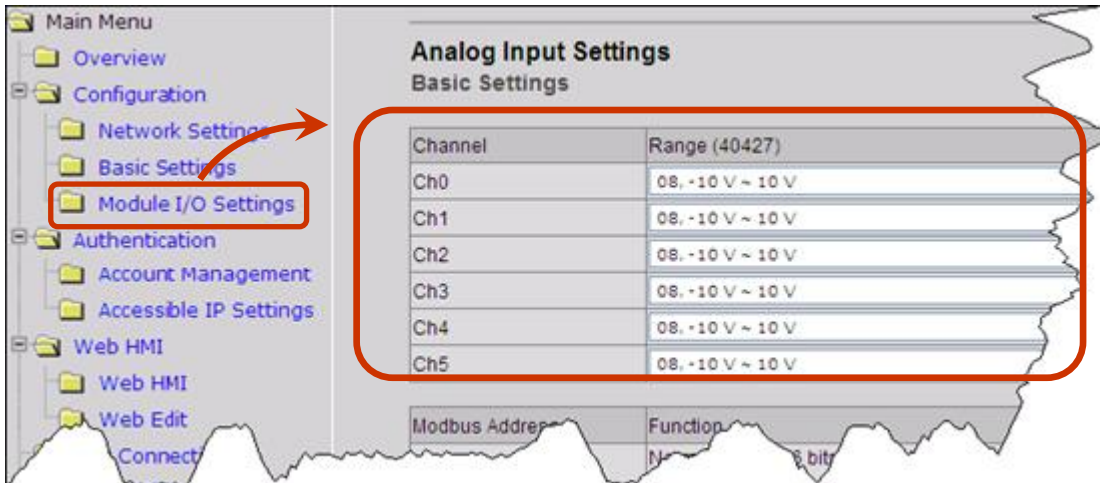

Wire Connections

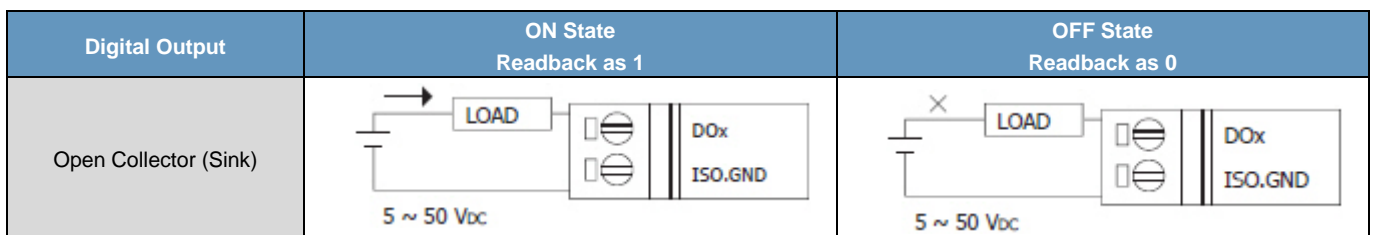

Modbus Register Table

Coils (0xxxx)

Register		Points	Description	Data Format	Attribute	Factory Value
DEC	HEX					
0000 : 0003	0000 : 0003	4	DO value	0: Off 1: On	R/W	-
00162 : 00169	00A2 : 00A9	8	Clear 1-ch historical AI max. value	1: Clear	W	-
00194 : 00201	00C2 : 00C9	8	Clear 1-ch historical AI min. value	1: Clear	W	-
00226	00E2	1	Reset the I/O settings to the factory default state	1: Reset	W	-
00233	00E9	1	Reboot the module	1: Reboot	W	-
00431	01AF	1	Save the DO power-on value to the EEPROM	1: Save	W/E	-
00432	01B0	1	Save the DO safe value to the EEPROM	1: Save	W/E	-
00435 : 00438	01B3 : 01B6	4	Enable/Disable the DO power-on value function	0: Disable 1: Enable	R/W	0
00515 : 00518	0203 : 0206	4	Enable/Disable the DO safe value function	0: Disable 1: Enable	R/W	0
00595 : 00602	0253 : 025A	8	Enable/Disable the AI function	0: Disable 1: Enable	R/W/E	1
00628	0274	1	Set the AI sampling rate	0: Normal mode (10 Hz, 16 bits) 1: Fast mode (60 Hz, 12 bits)	R/W/E	0
00629	0275	1	Set the AI noise filter	0: Frequency 60 Hz 1: Frequency: 50 Hz	R/W/E	0
00631	0277	1	Set the AI data format	0: Hexadecimal format 1: Engineering unit	R/W/E	0
00632	0278	1	Reset the AI calibration to the factory settings	1: Reset	W	-
00634	027A	1	Clear all historical AI max. values	1: Clear	W	-
00635	027B	1	Clear all historical AI min. values	1: Clear	W	-
00636 : 00643	027C : 0283	8	Enable/Disable the AI high alarm function	0: Disable 1: Enable	R/W/E	0
00668 : 00675	029C : 02A3	8	Enable/Disable the AI low alarm function	0: Disable 1: Enable	R/W/E	0
00700 : 00707	02BC : 02C3	8	Set the AI high alarm mode	0: Momentary mode 1: Latching mode	R/W/E	0
00732 : 00739	02DC : 02E3	8	Set the AI low alarm mode	0: Momentary mode 1: Latching mode	R/W/E	0
00764 : 00771	02FC : 0303	8	Clear the AI high alarm status	1: Clear	W	-
00796 : 00803	031C : 0323	8	Clear the AI low alarm status	1: Clear	W	-

ET-7000/PET-7000 Register Table, version 1.0.3

00830	033E	1	Enable/Disable the AI calibration	0: Disable 1: Enable	R/W	-
00831	033F	1	Zero calibration for the channel 0	1: Set	W	-
00832	0340	1	Span calibration for the channel 0	1: Set	W	-

Discrete Inputs (1xxxx)

Register		Points	Description	Data Format	Attribute
DEC	HEX				
10224 : 10231	00E0 : 00E7	8	Read AI high alarm status. When the AI value is higher than the high alarm value, the status becomes 1.	0: Normal 1: Alarmed	R
10256 : 10263	0100 : 0107	8	Read AI low alarm status. When the AI value is lower than the high alarm value, the status becomes 1.	0: Normal 1: Alarmed	R

Input Register (3xxxx)

Register		Points	No. Per Point	Description	Data Format	Attribute
DEC	HEX					
30000 : 30007	0000 : 0007	8	1	AI value	-32768 to 32767 (0x0000 to 0xFFFF)	R
30236 : 30243	00EC : 00F3	8	1	AI historical max. value	-32768 to 32767 (0x0000 to 0xFFFF)	R
30268 : 30275	010C : 0113	8	1	AI historical min. value	-32768 to 32767 (0x0000 to 0xFFFF)	R
30310	0136	1	1	Number of the DO channel	4	R
30320	0140	1	1	Number of the AI channel	8	R
30350	015E	1	1	OS image version	0x123 means version 1.2.3	R
30351	015F	1	1	Firmware version	0x123 means version 1.2.3	R
30353	0161	1	1	I/O version	0x123 means version 1.2.3	R
30360	0168	1	1	Communication state of the pair-connection	0: Normal <0: Failed	R

Holding Register (4xxxx)

Register		Points	No. Per Point	Description	Data Format	Attribute	Factory Value
DEC	HEX						
40271	010F	1	1	Set the module identification (Modbus NetID)	1 to 255	R/W/E	1
40296 : 40303	0128 : 012F	8	1	Set the AI high alarm value	-32768 to 32767 (0x0000 to 0xFFFF)	R/W/E	32767 (0x7FFF)
40328 : 40335	0148 : 014F	8	1	Set the AI low alarm value	-32768 to 32767 (0x0000 to 0xFFFF)	R/W/E	-32768 (0x8000)
40427 : 40434	01AB : 01B2	8	1	Set the AI range	0x07: 4 ~ 20 mA 0x08: +/-10 V 0x09: +/-5 V 0x0A: +/-1 V 0x0B: +/-500 mV 0x0C: +/-150 mV 0x0D: +/-20 mA 0x1A: 0~20 mA	R/W/E	0x08
40555	022B	1	1	Read the module reset status	1: Power-on 2: Module Watchdog 3: Software Reset Command	R	-
40556	022C	1	1	Read the boot count of the module The factory default value is 0 when the settings are set to the factory default values.	1 to 32767	R	-
40557	022D	1	1	Set the Host WDT timeout (unit: second)	0: Disable the Host WDT 5 to 65535: Enable the Host WDT	R/W/E	0
40558	022E	1	1	Read the WDT event count The initial value is 0 when the module is reset, and is increased when the WDT even happens.	0 to 32767	R	-
40559	022F	1	1	Read the module name	0x7017	R	-

ET-7017-10/PET-7017-10

I/O Specifications

Analog Input		
Input Channels	10 differential or 20 single-ended (Note) (software selectable)	
Input Type	+/-150 mV, +/-500 mV, +/-1 V, +/-5 V, +/-10 V, 0~20 mA, +/-20 mA, 4~20 mA (jumper selectable)	
Individual Channel Configuration	Yes	
Resolution	Normal Mode	16-bit
	Fast Mode	12-bit
Sampling Rate	Normal Mode	10 Samples/Sec. (Total)
	Fast Mode	60 Samples/Sec. (Total)
Accuracy	Normal Mode	+/-0.1%
	Fast Mode	+/-0.5% or better
Zero Drift	+/-20 μ V/ $^{\circ}$ C	
Span Drift	+/-25 ppm/ $^{\circ}$ C	
Overvoltage Protection	Differential	240 Vrms
	Single-ended	150 Vrms
Input Impedance	Voltage	2 M Ω (Differential), 1 M Ω (Single-ended)
	Current	125 Ω
Common Mode Rejection	86 dB Min.	
Normal Mode Rejection	100 dB	
Note: Differential mode can be used for voltage input and current input. Single-ended mode can be used for voltage input only		

Pin Assignments

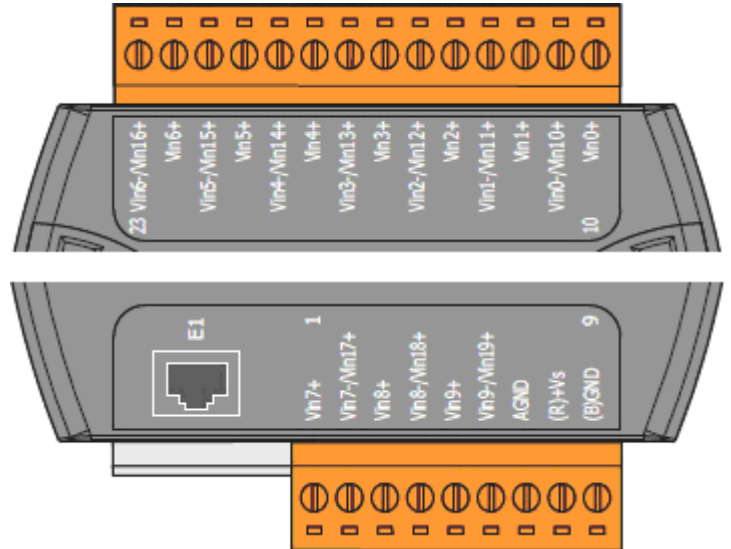

Voltage/Current Input Selection Jumper Settings

Channel	Vin6 ±	Vin5 ±	Vin4 ±	Vin3 ±	Vin2 ±	Vin1 ±	Vin0 ±
Jumper	J7	J6	J5	J4	J3	J2	J1

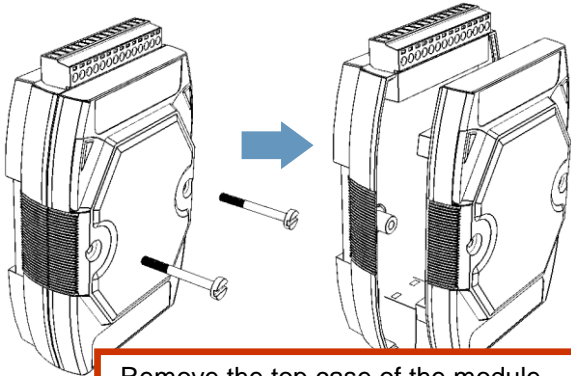

Remove the top case of the module.

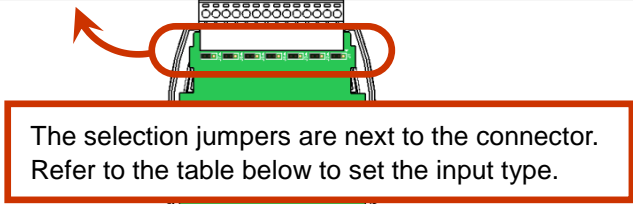

The selection jumpers are next to the connector. Refer to the table below to set the input type.

Channel	Vin7 ±	Vin8 ±	Vin79±
Jumper	J8	J9	J10

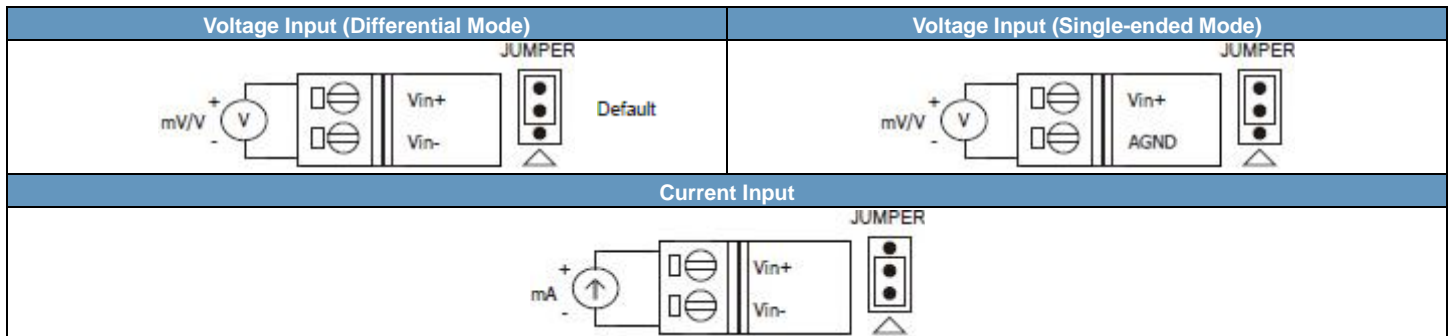

Tips & Warnings



The jumper settings of the input type for each AI channel must correspond to the input range for each AI channel of the web interface.

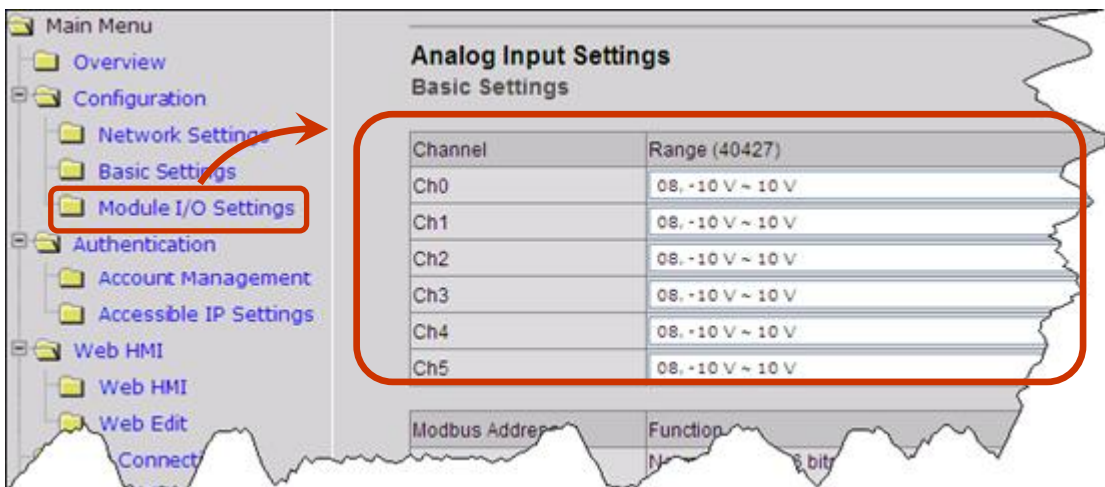

Modbus Register Table

Coils (0xxxx)

Register		Points	Description	Data Format	Attribute	Factory Value
DEC	HEX					
00162 : 00181	00A2 : 00B5	20	Clear 1-ch historical AI max. value	1: Clear	W	-
00194 : 00213	00C2 : 00D5	20	Clear 1-ch historical AI min. value	1: Clear	W	-
00226	00E2	1	Reset the I/O settings to the factory default state	1: Reset	W	-
00233	00E9	1	Reboot the module	1: Reboot	W	-
00595 : 00614	0253 : 0266	20	Enable/Disable the AI function	0: Disable 1: Enable	R/W/E	1
00628	0274	1	Set the AI sampling rate	0: Normal mode (10 Hz, 16 bits) 1: Fast mode (60 Hz, 12 bits)	R/W/E	0
00629	0275	1	Set the AI noise filter	0: Frequency 60 Hz 1: Frequency 50 Hz	R/W/E	0
00631	0277	1	Set the AI data format	0: Hexadecimal format 1: Engineering unit	R/W/E	0
00632	0278	1	Reset the AI calibration to the factory settings	1: Reset	W	-
00634	027A	1	Clear all historical AI max. values	1: Clear	W	-
00635	027B	1	Clear all historical AI min. values	1: Clear	W	-
00636 : 00655	027C : 028F	20	Enable/Disable the AI high alarm function	0: Disable 1: Enable	R/W/E	0
00668 : 00687	029C : 02AF	20	Enable/Disable the AI low alarm function	0: Disable 1: Enable	R/W/E	0
00700 : 00719	02BC : 02CF	20	Set the AI high alarm mode	0: Momentary mode 1: Latching mode	R/W/E	0
00732 : 00751	02DC : 02EF	20	Set the AI low alarm mode	0: Momentary mode 1: Latching mode	R/W/E	0
00764 : 00783	02FC : 030F	20	Clear the AI high alarm status	1: Clear	W	-
00796 : 00815	031C : 032F	20	Clear the AI low alarm status	1: Clear	W	-
00830	033E	1	Enable/Disable the AI calibration	0: Disable 1: Enable	R/W	-
00831	033F	1	Zero calibration for the channel 0	1: Set	W	-
00832	0340	1	Span calibration for the channel 0	1: Set	W	-
00833	0341	1	Set the AI mode	0: Differential 1: Single-ended	R/W/E	0

Discrete Inputs (1xxxx)

Register		Points	Description	Data Format	Attribute
DEC	HEX				
10224 :	00E0 :	20	Read AI high alarm status. When the AI value is higher than the high alarm value, the status becomes 1.	0: Normal 1: Alarmed	
10243	00F3				
10256 :	0100 :	20	Read AI low alarm status. When the AI value is lower than the high alarm value, the status becomes 1.	0: Normal 1: Alarmed	
10275	0113				

Input Register (3xxxx)

Register		Points	No. Per Point	Description	Data Format	Attribute
DEC	HEX					
30000 :	0000 :	20	1	AI value	-32768 to 32767 (0x0000 to 0xFFFF)	R
30019	0013					
30236 :	00EC :	20	1	AI historical max. value	-32768 to 32767 (0x0000 to 0xFFFF)	R
30255	00FF					
30268 :	010C :	20	1	AI historical min. value	-32768 to 32767 (0x0000 to 0xFFFF)	R
30287	011F					
30320	0140	1	1	Number of the AI channel	10/20	R
30350	015E	1	1	OS image version	0x123 means version 1.2.3	R
30351	015F	1	1	Firmware version	0x123 means version 1.2.3	R
30353	0161	1	1	I/O version	0x123 means version 1.2.3	R

Holding Register (4xxxx)

Register		Points	No. Per Point	Description	Data Format	Attribute	Factory Value
DEC	HEX						
40271	010F	1	1	Set the module identification (Modbus NetID)	1 to 255	R/W/E	1
40296 : 40315	0128 : 013B	20	1	Set the AI high alarm value	-32768 to 32767 (0x0000 to 0xFFFF)	R/W/E	32767 (0x7FFF)
40328 : 40347	0148 : 015B	20	1	Set the AI low alarm value	-32768 to 32767 (0x0000 to 0xFFFF)	R/W/E	-32768 (0x8000)
40427 : 40446	01AB : 01BF	20	1	Set the AI range	0x07: 4 ~ 20 mA 0x08: +/-10 V 0x09: +/-5 V 0x0A: +/-1 V 0x0B: +/-500 mV 0x0C: +/-150 mV 0x0D: +/-20 mA 0x1A: 0~20 mA	R/W/E	0x08
40555	022B	1	1	Read the module reset status	1: Power-on 2: Module Watchdog 3: Software Reset Command	R	-
40556	022C	1	1	Read the boot count of the module The factory default value is 0 when the settings are set to the factory default values.	1 to 32767	R	-
40557	022D	1	1	Set the Host WDT timeout (unit: second)	0: Disable the Host WDT 5 to 65535: Enable the Host WDT	R/W/E	0
40558	022E	1	1	Read the WDT event count The initial value is 0 when the module is reset, and is increased when the WDT even happens.	0 to 32767	R	-
40559	022F	1	1	Read the module name	0x7017	R	-

ET-7018Z/PET-7018Z

I/O Specifications

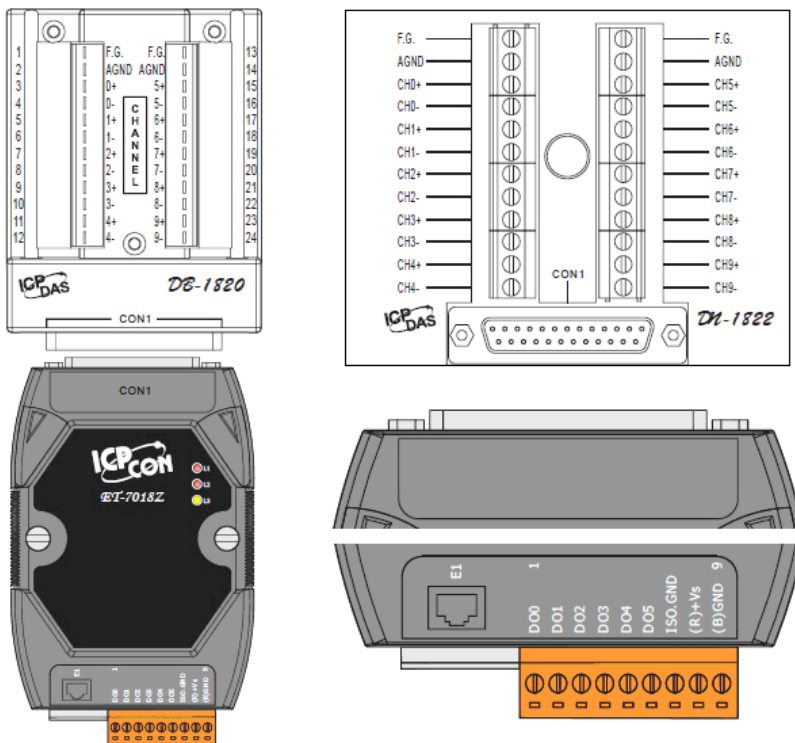

Analog Input	
Input Channels	10 (Differential)
Input Type	+/-15 mV, +/-50 mV, +/-100 mV, +/-500 mV, +/-1 V, +/-2.5V 0~20 mA, +/-20 mA, 4~20 mA (Requires Optional External 125Ω Resistor) Thermocouple (J, K, T, E, R, S, B, N, C, L, M and LDIN43710)
Individual Channel Configuration	Yes
Resolution	16-bit
Sampling Rate	10 Samples/Sec. (Total)
Accuracy	+/-0.1% or better
Zero Drift	+/-0.5 uV/°C
Span Drift	+/-25 ppm/°C
Overvoltage Protection	240 Vrms
Input Impedance	>300 KΩ
Common Mode Rejection	150 dB Min.
Normal Mode Rejection	100 dB
Temperature Outputs Consistency	Yes
Stable Temperature Output In The Field	Yes
Open Wire Detection	Yes
Digital Output	
Output Channels	6
Type	Isolated Open Collector (Sink)
Max. Load Current	700 mA/Channel
Load Voltage	5 VDC~50 VDC
Overvoltage Protection	60 VDC
Overload Protection	1.4 A
Short-circuit Protection	Yes
Power-on Value	Yes, Programmable
Safe Value	Yes, Programmable

Pin Assignments

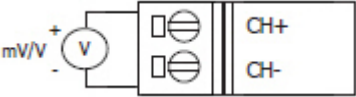

ET-7000/PET-7000 Register Table, version 1.0.3

Wire Connections

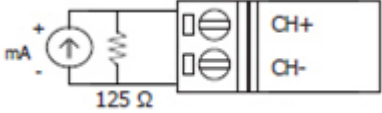
Voltage Input	Thermocouple Input
	
Current Input	
	<p>Note that an optional external 125 Ω resistor is required when connecting to a current source,</p>

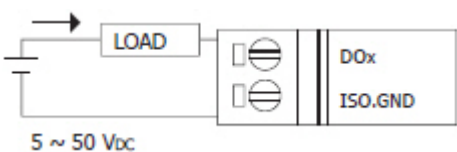
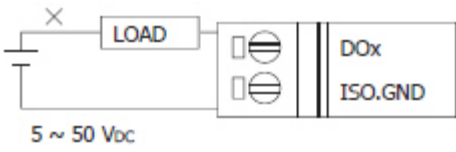
Digital Output	ON State Readback as 1	OFF State Readback as 0
Open Collector (Sink)		

Modbus Register Table

Coils (0xxxx)

Register		Points	Description	Data Format	Attribute	Factory Value
DEC	HEX					
0000 : 0005	0000 : 0005	6	DO value	0: Off 1: On	R/W	-
00162 : 00171	00A2 : 00AB	10	Clear 1-ch historical AI max. value	1: Clear	W	-
00194 : 00203	00C2 : 00CB	10	Clear 1-ch historical AI min. value	1: Clear	W	-
00226	00E2	1	Reset the I/O settings to the factory default state	1: Reset	W	-
00233	00E9	1	Reboot the module	1: Reboot	W	-
00431	01AF	1	Save the DO power-on value to the EEPROM	1: Save	W/E	-
00432	01B0	1	Save the DO safe value to the EEPROM	1: Save	W/E	-
00435 : 00440	01B3 : 01B8	6	Enable/Disable the DO power-on value function	0: Disable 1: Enable	R/W	0
00515 : 00520	0203 : 0208	6	Enable/Disable the DO safe value function	0: Disable 1: Enable	R/W	0
00595 : 00604	0253 : 025C	10	Enable/Disable the AI function	0: Disable 1: Enable	R/W/E	1
00627	0273	1	Enable/Disable the CJC function	0: Disable 1: Enable	R/W/E	1
00629	0275	1	Set the AI noise filter	0: Frequency 60 Hz 1: Frequency 50 Hz	R/W/E	0
00631	0277	1	Set the AI data format	0: Hexadecimal format 1: Engineering unit	R/W/E	0
00632	0278	1	Reset the AI calibration to the factory settings	1: Reset	W	-
00634	027A	1	Clear all historical AI max. values	1: Clear	W	-
00635	027B	1	Clear all historical AI min. values	1: Clear	W	-
00636 : 00645	027C : 0285	10	Enable/Disable the AI high alarm function	0: Disable 1: Enable	R/W/E	0
00668 : 00677	029C : 02A5	10	Enable/Disable the AI low alarm function	0: Disable 1: Enable	R/W/E	0
00700 : 00709	02BC : 02C5	10	Set the AI high alarm mode	0: Momentary mode 1: Latching mode	R/W/E	0
00732 : 00741	02DC : 02E5	10	Set the AI low alarm mode	0: Momentary mode 1: Latching mode	R/W/E	0
00764 : 00773	02FC : 0305	10	Clear the AI high alarm status	1: Clear	W	-
00796 : 00805	031C : 0325	10	Clear the AI low alarm status	1: Clear	W	-
00830	033E	1	Enable/Disable the AI calibration	0: Disable	R/W	-

ET-7000/PET-7000 Register Table, version 1.0.3

				1: Enable		
00831	033F	1	Zero calibration for the channel 0	1: Set	W	-
00832	0340	1	Span calibration for the channel 0	1: Set	W	-

Discrete Inputs (1xxxx)

Register		Points	Description	Data Format	Attribute
DEC	HEX				
10224 : 10233	00E0 : 00E9	10	Read AI high alarm status. When the AI value is higher than the high alarm value, the status becomes 1.	0: Normal 1: Alarmed	R
10256 : 10265	0100 : 0109	10	Read AI low alarm status. When the AI value is lower than the high alarm value, the status becomes 1.	0: Normal 1: Alarmed	R

Input Register (3xxxx)

Register		Points	No. Per Point	Description	Data Format	Attribute
DEC	HEX					
30000 : 30009	0000 : 0009	10	1	AI value	-32768 to 32767 (0x0000 to 0xFFFF)	R
30143	008F	1	1	CJC value	-32768 to 32767	R
30236 : 30245	00EC : 00F5	10	1	AI historical max. value	-32768 to 32767 (0x0000 to 0xFFFF)	R
30268 : 30277	010C : 0115	10	1	AI historical min. value	-32768 to 32767 (0x0000 to 0xFFFF)	R
30310	0136	1	1	Number of the DO channel	6	R
30320	0140	1	1	Number of the AI channel	10	R
30350	015E	1	1	OS image version	0x123 means version 1.2.3	R
30351	015F	1	1	Firmware version	0x123 means version 1.2.3	R
30353	0161	1	1	I/O version	0x123 means version 1.2.3	R
30360	0168	1	1	Communication state of the pair-connection	0: Normal <0: Failed	R

Holding Register (4xxxx)

Register		Points	No. Per Point	Description	Data Format	Attribute	Factory Value
DEC	HEX						
40271	010F	1	1	Set the module identification (Modbus NetID)	1 to 255	R/W/E	1
40296 : 40305	0128 : 0131	10	1	Set the AI high alarm value	-32768 to 32767 (0x0000 to 0xFFFF)	R/W/E	32767 (0x7FFF)
40328 : 40337	0148 : 0151	10	1	Set the AI low alarm value	-32768 to 32767 (0x0000 to 0xFFFF)	R/W/E	-32768 (0x8000)
40427 : 40436	01AB : 01B4	10	1	Set the AI range	0x00: +/-15 mV 0x01: +/-50 mV 0x02: +/-100 mV 0x03: +/-500 mV 0x04: +/-1 V 0x05: +/-2.5 V 0x06: +/-20 mA 0x07: 4 ~ 20 mA 0x0E: Type J, -210°C ~ 760°C 0x0F: Type K, -270°C ~ 1372°C 0x10: Type T, -270°C ~ 400°C 0x11: Type E, -270°C ~ 1000°C 0x12: Type R, 0°C ~ 1768°C 0x13: Type S, 0°C ~ 1768°C 0x14: Type B, 0°C ~ 1820°C 0x15: Type N, -270°C ~ 1300°C 0x16: Type C, 0°C ~ 2320°C 0x17: Type L, -200°C ~ 800°C 0x18: Type M, -200°C ~ 100°C 0x19: Type L DIN43710, -200°C ~ 900°C 0x1A: 0 ~ 20 mA	R/W/E	0x05
40491 : 40500	01EB : 01F4	10	1	Set the CJC Offset for the single channel	-9999 to 9999	R/W/E	0
40523	020B	1	1	Set the CJC Offset for all channels	-9999 to 9999	R/W/E	0
40555	022B	1	1	Read the module reset status	1: Power-on 2: Module Watchdog 3: Software Reset Command	R	-
40556	022C	1	1	Read the boot count of the module The factory default value is 0 when the settings are set to the factory default values.	1 to 32767	R	-
40557	022D	1	1	Set the Host WDT timeout (unit: second)	0: Disable the Host WDT 5 to 65535: Enable the Host WDT	R/W/E	0
40558	022E	1	1	Read the WDT event count The initial value is 0 when the module is reset, and is increased when the WDT even happens.	0 to 32767	R	-
40559	022F	1	1	Read the module name	0x7018	R	-
40589	024D	1	1	Set the CJC operation status	0: Stop 1: Start 2: Read once	R/W/E	1

ET-7019/PET-7019

I/O Specifications

Analog Input		
Input Channels	8 (Differential)	
Input Type	+/-15 mV, +/-50 mV, +/-100 mV, +/-150 mV, +/-500 mV, +/-1 V, +/-5 V, +/-10 V, 0~20 mA, +/-20 mA, 4~20 mA Thermocouple (J, K, T, E, R, S, B, N, C, L, M and LDIN43710)	
Individual Channel Configuration	Yes	
Resolution	16-bit	
Sampling Rate	10 Samples/Sec. (Total)	
Accuracy	+/-0.1% or better	
Zero Drift	+/-10 uV/°C	
Span Drift	+/-25 ppm/°C	
Overvoltage Protection	240 Vrms	
Input Impedance	Voltage	>1 MΩ
	Current	125 Ω
Common Mode Rejection	86 dB Min.	
Normal Mode Rejection	100 dB	
Open Wire Detection	Yes	
Digital Output		
Output Channels	4	
Type	Isolated Open Collector (Sink)	
Max. Load Current	700 mA/Channel	
Load Voltage	5 VDC~50 VDC	
Overvoltage Protection	60 VDC	
Overload Protection	1.4 A	
Short-circuit Protection	Yes	
Power-on Value	Yes, Programmable	
Safe Value	Yes, Programmable	

Pin Assignments

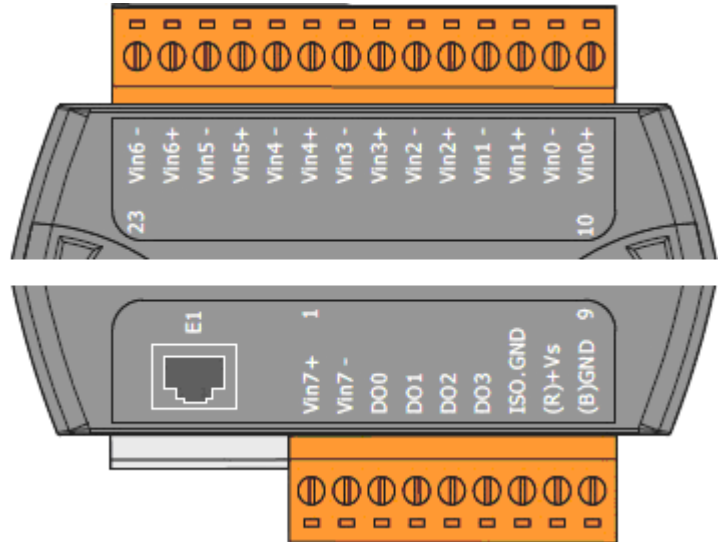

Voltage/Current Input Selection Jumper Settings

Remove the top case of the module.

Channel	Vin6 ±	Vin5 ±	Vin4 ±	Vin3 ±	Vin2 ±	Vin1 ±	Vin0 ±
Jumper	J7	J6	J5	J4	J3	J2	J1

The selection jumpers are next to the connector. Refer to the table below to set the input type.

Channel	Vin7 ±
Jumper	J8

Voltage Input	Thermocouple Input
Current Input	

Tips & Warnings



The jumper settings of the input type for each AI channel must correspond to the input range for each AI channel of the web interface.

Analog Input Settings
Basic Settings

Channel	Range (40427)
Ch0	08, -10 V ~ 10 V
Ch1	08, -10 V ~ 10 V
Ch2	08, -10 V ~ 10 V
Ch3	08, -10 V ~ 10 V
Ch4	08, -10 V ~ 10 V
Ch5	08, -10 V ~ 10 V

Wire Connections

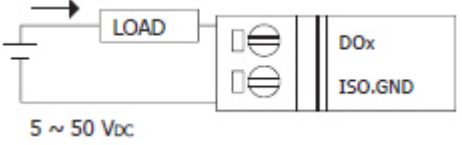
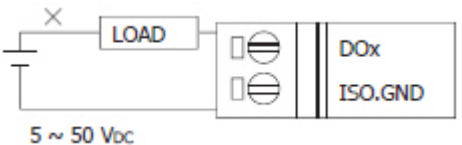
Digital Output	ON State Readback as 1	OFF State Readback as 0
Open Collector (Sink)	 <p>5 ~ 50 Vdc</p>	 <p>5 ~ 50 Vdc</p>

Modbus Register Table

Coils (0xxxx)

Register		Points	Description	Data Format	Attribute	Factory Value
DEC	HEX					
0000 : 0003	0000 : 0003	4	DO value	0: Off 1: On	R/W	-
00162 : 00169	00A2 : 00A9	8	Clear 1-ch historical AI max. value	1: Clear	W	-
00194 : 00201	00C2 : 00C9	8	Clear 1-ch historical AI min. value	1: Clear	W	-
00226	00E2	1	Reset the I/O settings to the factory default state	1: Reset	W	-
00233	00E9	1	Reboot the module	1: Reboot	W	-
00431	01AF	1	Save the DO power-on value to the EEPROM	1: Save	W/E	-
00432	01B0	1	Save the DO safe value to the EEPROM	1: Save	W/E	-
00435 : 00438	01B3 : 01B6	4	Enable/Disable the DO power-on value function	0: Disable 1: Enable	R/W	0
00515 : 00518	0203 : 0206	4	Enable/Disable the DO safe value function	0: Disable 1: Enable	R/W	0
00595 : 00602	0253 : 025A	8	Enable/Disable the AI function	0: Disable 1: Enable	R/W/E	1
00627	0273	1	Enable/Disable the CJC function	0: Disable 1: Enable	R/W/E	1
00629	0275	1	Set the AI noise filter	0: Frequency 60 Hz 1: Frequency 50 Hz	R/W/E	0
00631	0277	1	Set the AI data format	0: Hexadecimal format 1: Engineering unit	R/W/E	0
00632	0278	1	Reset the AI calibration to the factory settings	1: Reset	W	-
00634	027A	1	Clear all historical AI max. values	1: Clear	W	-
00635	027B	1	Clear all historical AI min. values	1: Clear	W	-
00636 : 00643	027C : 0283	8	Enable/Disable the AI high alarm function	0: Disable 1: Enable	R/W/E	0
00668 : 00675	029C : 02A3	8	Enable/Disable the AI low alarm function	0: Disable 1: Enable	R/W/E	0
00700 : 00707	02BC : 02C3	8	Set the AI high alarm mode	0: Momentary mode 1: Latching mode	R/W/E	0
00732 : 00739	02DC : 02E3	8	Set the AI low alarm mode	0: Momentary mode 1: Latching mode	R/W/E	0
00764 : 00771	02FC : 0303	8	Clear the AI high alarm status	1: Clear	W	-
00796 : 00803	031C : 0323	8	Clear the AI low alarm status	1: Clear	W	-
00830	033E	1	Enable/Disable the AI calibration	0: Disable 1: Enable	R/W	-

ET-7000/PET-7000 Register Table, version 1.0.3

00831	033F	1	Zero calibration for channel 0	1: Active	W	-
00832	0340	1	Span calibration for channel 0	1: Active	W	-

Discrete Inputs (1xxxx)

Register		Points	Description	Data Format	Attribute
DEC	HEX				
10224	00E0	8	Read AI high alarm status. When the AI value is higher than the high alarm value, the status becomes 1.	0: Normal 1: Alarmed	R
:	:				
10231	00E7				
10256	0100	8	Read AI low alarm status. When the AI value is lower than the high alarm value, the status becomes 1.	0: Normal 1: Alarmed	R
:	:				
10263	0107				

Input Register (3xxxx)

Register		Points	No. Per Point	Description	Data Format	Attribute
DEC	HEX					
30000	0000	8	1	AI value	-32768 to 32767 (0x0000 to 0xFFFF)	R
:	:					
30007	0007					
30143	008F	1	1	CJC value	-32768 to 32767	R
30236	00EC	8	1	AI historical max. value	-32768 to 32767 (0x0000 to 0xFFFF)	R
:	:					
30243	00F3					
30268	010C	8	1	AI historical min. value	-32768 to 32767 (0x0000 to 0xFFFF)	R
:	:					
30275	0113					
30310	0136	1	1	Number of the DO channel	4	R
30320	0140	1	1	Number of the AI channel	8	R
30350	015E	1	1	OS image version	0x123 means version 1.2.3	R
30351	015F	1	1	Firmware version	0x123 means version 1.2.3	R
30353	0161	1	1	I/O version	0x123 means version 1.2.3	R
30360	0168	1	1	Communication state of the pair-connection	0: Normal <0: Failed	R

Holding Register (4xxxx)

Register		Points	No. Per Point	Description	Data Format	Attribute	Factory Value
DEC	HEX						
40271	010F	1	1	Set the module identification (Modbus NetID)	1 to 255	R/W/E	1
40296 : 40303	0128 : 012F	8	1	Set the AI high alarm value	-32768 to 32767 (0x0000 to 0xFFFF)	R/W/E	32767 (0x7FFF)
40328 : 40335	0148 : 014F	8	1	Set the AI low alarm value	-32768 to 32767 (0x0000 to 0xFFFF)	R/W/E	-32768 (0x8000)
40427 : 40434	01AB : 01B2	8	1	Set the AI range	0x00: +/-15 mV 0x01: +/-50 mV 0x02: +/-100 mV 0x03: +/-500 mV 0x04: +/-1 V 0x05: +/-2.5 V 0x06: +/-20 mA 0x07: 4 ~ 20 mA 0x0E: Type J, -210°C ~ 760°C 0x0F: Type K, -270°C ~ 1372°C 0x10: Type T, -270°C ~ 400°C 0x11: Type E, -270°C ~ 1000°C 0x12: Type R, 0°C ~ 1768°C 0x13: Type S, 0°C ~ 1768°C 0x14: Type B, 0°C ~ 1820°C 0x15: Type N, -270°C ~ 1300°C 0x16: Type C, 0°C ~ 2320°C 0x17: Type L, -200°C ~ 800°C 0x18: Type M, -200°C ~ 100°C 0x19: Type L DIN43710, -200°C ~ 900°C 0x1A: 0 ~ 20 mA	R/W/E	0x05
40491 : 40598	01EB : 01F2	8	1	Set the CJC Offset for the single channel	-9999 to 9999	R/W/E	0
40523	020B	1	1	Set the CJC Offset for all channels	-9999 to 9999	R/W/E	0
40555	022B	1	1	Read the module reset status	1: Power-on 2: Module Watchdog 3: Software Reset Command	R	-
40556	022C	1	1	Read the boot count of the module The factory default value is 0 when the settings are set to the factory default values.	1 to 32767	R	-
40557	022D	1	1	Set the Host WDT timeout (unit: second)	0: Disable the Host WDT 5 to 65535: Enable the Host WDT	R/W/E	0
40558	022E	1	1	Read the WDT event count The initial value is 0 when the module is reset, and is increased when the WDT even happens.	0 to 32767	R	-
40559	022F	1	1	Read the module name	0x7019	R	-
40589	024D	1	1	Set the CJC operation status	0: Stop 1: Start 2: Read once	R/W/E	1

ET-7000/PET-7000 Register Table, version 1.0.3

ET-7019Z/PET-7019Z

I/O Specifications

Analog Input	
Input Channels	10 (Differential)
Input Type	+/-15 mV, +/-50 mV, +/-100 mV, +/-150 mV, +/-500 mV, +/-1 V, +/-2.5V, +/-5 V, +/-10 V 0~20 mA, +/-20 mA, 4~20 mA (Jumper Selectable) Thermocouple (J, K, T, E, R, S, B, N, C, L, M and LDIN43710)
Individual Channel Configuration	Yes
Resolution	16-bit
Sampling Rate	10 Samples/Sec. (Total)
Accuracy	+/-0.1% or better
Zero Drift	+/-0.5 uV/°C
Span Drift	+/-25 ppm/°C
Oversvoltage Protection	240 Vrms
Input Impedance	>300 KΩ
Common Mode Rejection	86 dB Min.
Normal Mode Rejection	100 dB
Temperature Outputs Consistency	Yes
Stable Temperature Output In The Field	Yes
Open Wire Detection	Yes
Digital Output	
Output Channels	6
Type	Isolated Open Collector (Sink)
Max. Load Current	700 mA/Channel
Load Voltage	5 VDC~50 VDC
Oversvoltage Protection	60 VDC
Overload Protection	1.4 A
Short-circuit Protection	Yes
Power-on Value	Yes, Programmable
Safe Value	Yes, Programmable

Pin Assignments

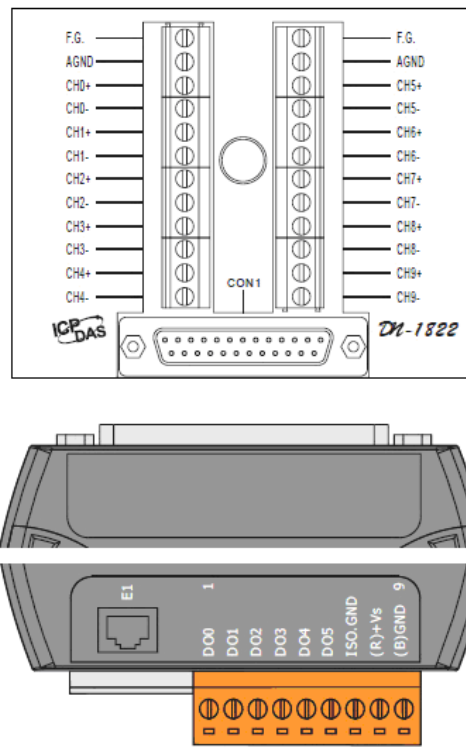
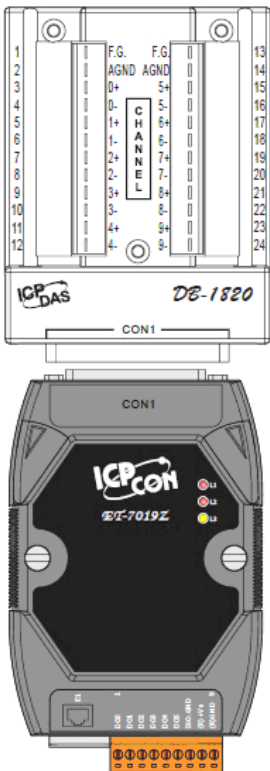

ET-7000/PET-7000 Register Table, version 1.0.3

Voltage/Current Input Selection Jumper Settings

Channel	CH0 ±	CH1 ±	CH2±	CH3±	CH4±	CH5±	CH6±	CH7±
Jumper	J1	J2	J3	J4	J5	J6	J7	J8

Channel	CH8 ±	CH9 ±
Jumper	J9	J10

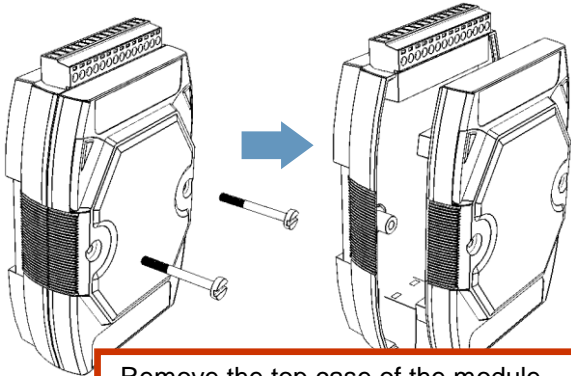

Remove the top case of the module.

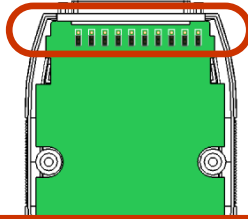

The selection jumpers are next to the connector. Refer to the table below to set the input type.

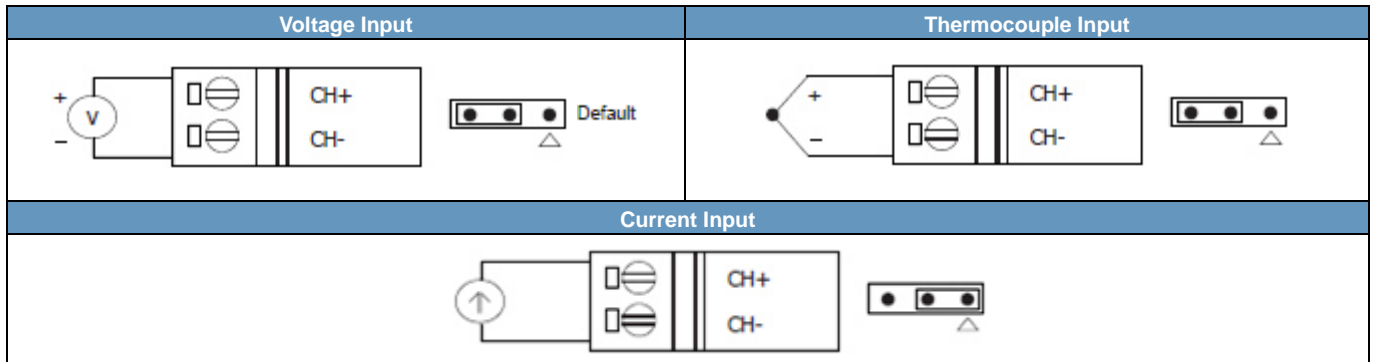

Tips & Warnings



The jumper settings of the input type for each AI channel must correspond to the input range for each AI channel of the web interface.

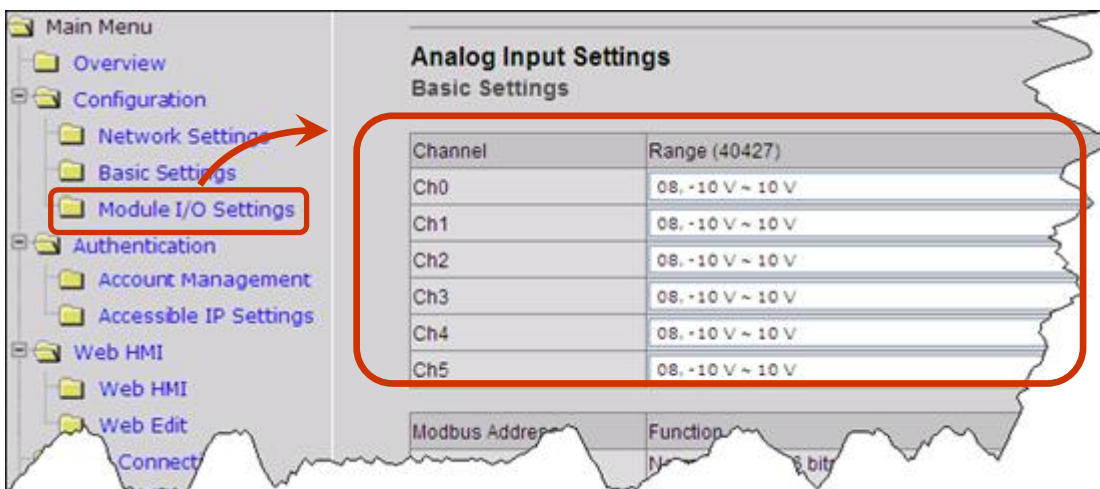

Wire Connections

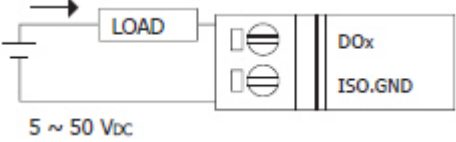
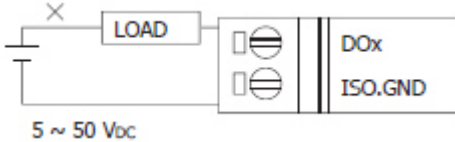
Digital Output	ON State Readback as 1	OFF State Readback as 0
Open Collector (Sink)	 <p>5 ~ 50 Vdc</p>	 <p>5 ~ 50 Vdc</p>

Modbus Register Table

Coils (0xxxx)

Register		Points	Description	Data Format	Attribute	Factory Value
DEC	HEX					
0000 : 0005	0000 : 0005	6	DO value	0: Off 1: On	R/W	-
00162 : 00171	00A2 : 00AB	10	Clear 1-ch historical AI max. value	1: Clear	W	-
00194 : 00203	00C2 : 00CB	10	Clear 1-ch historical AI min. value	1: Clear	W	-
00226	00E2	1	Reset the I/O settings to the factory default state	1: Reset	W	-
00233	00E9	1	Reboot the module	1: Reboot	W	-
00431	01AF	1	Save the DO power-on value to the EEPROM	1: Save	W/E	-
00432	01B0	1	Save the DO safe value to the EEPROM	1: Save	W/E	-
00435 : 00440	01B3 : 01B8	6	Enable/Disable the DO power-on value function	0: Disable 1: Enable	R/W	0
00515 : 00520	0203 : 0208	6	Enable/Disable the DO safe value function	0: Disable 1: Enable	R/W	0
00595 : 00604	0253 : 025C	10	Enable/Disable the AI function	0: Disable 1: Enable	R/W/E	1
00627	0273	1	Enable/Disable the CJC function	0: Disable 1: Enable	R/W/E	1
00629	0275	1	Set the AI noise filter	0: Frequency 60 Hz 1: Frequency 50 Hz	R/W/E	0
00631	0277	1	Set the AI data format	0: Hexadecimal format 1: Engineering unit	R/W/E	0
00632	0278	1	Reset the AI calibration to the factory settings	1: Reset	W	-
00634	027A	1	Clear all historical AI max. values	1: Clear	W	-
00635	027B	1	Clear all historical AI min. values	1: Clear	W	-
00636 : 00645	027C : 0285	10	Enable/Disable the AI high alarm function	0: Disable 1: Enable	R/W/E	0
00668 : 00677	029C : 02A5	10	Enable/Disable the AI low alarm function	0: Disable 1: Enable	R/W/E	0
00700 : 00709	02BC : 02C5	10	Set the AI high alarm mode	0: Momentary mode 1: Latching mode	R/W/E	0
00732 : 00741	02DC : 02E5	10	Set the AI low alarm mode	0: Momentary mode 1: Latching mode	R/W/E	0
00764 : 00773	02FC : 0305	10	Clear the AI high alarm status	1: Clear	W	-
00796 : 00805	031C : 0325	10	Clear the AI low alarm status	1: Clear	W	-
00830	033E	1	Enable/Disable the AI calibration	0: Disable 1: Enable	R/W	-

ET-7000/PET-7000 Register Table, version 1.0.3

00831	033F	1	Zero calibration for the channel 0	1: Set	W	-
00832	0340	1	Span calibration for the channel 0	1: Set	W	-

Discrete Inputs (1xxxx)

Register		Points	Description	Data Format	Attribute
DEC	HEX				
10224	00E0	10	Read AI high alarm status. When the AI value is higher than the high alarm value, the status becomes 1.	0: Normal 1: Alarmed	R
:	:				
10233	00E9				
10256	0100	10	Read AI low alarm status. When the AI value is lower than the high alarm value, the status becomes 1.	0: Normal 1: Alarmed	R
:	:				
10265	0109				

Input Register (3xxxx)

Register		Points	No. Per Point	Description	Data Format	Attribute
DEC	HEX					
30000	0000	10	1	AI value	-32768 to 32767 (0x0000 to 0xFFFF)	R
:	:					
30009	0009					
30143	008F	1	1	CJC value	-32768 to 32767	R
30236	00EC	10	1	AI historical max. value	-32768 to 32767 (0x0000 to 0xFFFF)	R
:	:					
30245	00F5					
30268	010C	10	1	AI historical min. value	-32768 to 32767 (0x0000 to 0xFFFF)	R
:	:					
30277	0115					
30310	0136	1	1	Number of the DO channel	6	R
30320	0140	1	1	Number of the AI channel	10	R
30350	015E	1	1	OS image version	0x123 means version 1.2.3	R
30351	015F	1	1	Firmware version	0x123 means version 1.2.3	R
30353	0161	1	1	I/O version	0x123 means version 1.2.3	R
30360	0168	1	1	Communication state of the pair-connection	0: Normal <0: Failed	R

Holding Register (4xxxx)

Register		Points	No. Per Point	Description	Data Format	Attribute	Factory Value
DEC	HEX						
40271	010F	1	1	Set the module identification (Modbus NetID)	1 to 255	R/W/E	1
40296 : 40305	0128 : 0131	10	1	Set the AI high alarm value	-32768 to 32767 (0x0000 to 0xFFFF)	R/W/E	32767 (0x7FFF)
40328 : 40337	0148 : 0151	10	1	Set the AI low alarm value	-32768 to 32767 (0x0000 to 0xFFFF)	R/W/E	-32768 (0x8000)
40427 : 40436	01AB : 01B4	10	1	Set the AI range	0x00: +/-15 mV 0x01: +/-50 mV 0x02: +/-100 mV 0x03: +/-500 mV 0x04: +/-1 V 0x05: +/-2.5 V 0x06: +/-20 mA 0x07: 4 ~ 20 mA 0x08: +/-10 V 0x09: +/-5 V 0x0A: +/-1V 0x0B: +/-500 mV 0x0C: +/-150 mV 0x0D: +/-20 mA 0x0E: Type J, -210°C ~ 760°C 0x0F: Type K, -270°C ~ 1372°C 0x10: Type T, -270°C ~ 400°C 0x11: Type E, -270°C ~ 1000°C 0x12: Type R, 0°C ~ 1768°C 0x13: Type S, 0°C ~ 1768°C 0x14: Type B, 0°C ~ 1820°C 0x15: Type N, -270°C ~ 1300°C 0x16: Type C, 0°C ~ 2320°C 0x17: Type L, -200°C ~ 800°C 0x18: Type M, -200°C ~ 100°C 0x19: Type L DIN43710, -200°C ~ 900°C 0x1A: 0 ~ 20 mA	R/W/E	0x05
40491 : 40500	01EB : 01F4	10	1	Set the CJC Offset for the single channel	-9999 to 9999	R/W/E	0
40523	020B	1	1	Set the CJC Offset for all channels	-9999 to 9999	R/W/E	0
40555	022B	1	1	Read the module reset status	1: Power-on 2: Module Watchdog 3: Software Reset Command	R	-
40556	022C	1	1	Read the boot count of the module The factory default value is 0 when the settings are set to the factory default values.	1 to 32767	R	-
40557	022D	1	1	Set the Host WDT timeout (unit: second)	0: Disable the Host WDT 5 to 65535: Enable the Host WDT	R/W/E	0
40558	022E	1	1	Read the WDT event count The initial value is 0 when the module is reset, and is increased	0 to 32767	R	-

ET-7000/PET-7000 Register Table, version 1.0.3

				when the WDT even happens.			
40559	022F	1	1	Read the module name	0x7019	R	-
40589	024D	1	1	Set the CJC operation status	0: Stop 1: Start 2: Read once	R/W/E	1

ET-7026/PET-7026

I/O Specifications

Analog Input		
Input Channels	6 (Differential)	
Input Type	+/-500 mV, +/-1 V, +/-5 V, +/-10 V, 0~20 mA, +/-20 mA, 4~20 mA (jumper selectable)	
Individual Channel Configuration	Yes	
Resolution	Normal Mode	16-bit
	Fast Mode	12-bit
Sampling Rate	Normal Mode	10 Samples/Sec. (Total)
	Fast Mode	60 Samples/Sec. (Total)
Accuracy	Normal Mode	+/-0.1%
	Fast Mode	+/-0.5% or better
Zero Drift	+/-20 uV/°C or better	
Span Drift	+/-25 ppm/°C	
Overvoltage Protection	240 Vrms	
Input Impedance	2 MΩ	
Common Mode Rejection	86 dB Min.	
Normal Mode Rejection	100 dB	
Analog Output		
Output Channels	2	
Output Type	0~5 V, +/-5 V, 0~10 V, +/-10 V 0~20 mA, 4~20 mA (jumper selectable)	
Individual Channel Configuration	Yes	
Resolution	12-bit	
Accuracy	+/-0.1% of FSR	
Voltage Output Capability	20 mA @ 10 V	
Current Load Resistance	500 Ω	
Open Wire Detection	Yes, for 4~20 mA only	
Power On Value	Yes, Programmable	
Safe Value	Yes, Programmable	
Digital Input/Counter		
Input Channels	2	
Dry Contact (Source)	On Voltage Level	Close to GND
	Off Voltage Level	Open
	Effective Distance for Dry Contact	500M max.
Wet Contact (Sink/Source)	On Voltage Level	+3.5 VDC ~ +30VDC
	Off Voltage Level	+1 VDC max.
Counter	Channels	2
	Max. Counts	4,294,967,285 (32-bit)
	Max. Input Frequency	100 Hz
	Min. Pulse Width	5 ms
Overvoltage Protection	30 VDC	
Digital Output		
Output Channels	2	
Type	Isolated Open Collector (Sink)	
Max. Load Current	700 mA/Channel	
Load Voltage	+5 VDC ~ +50 VDC	
Overvoltage Protection	60 VDC	
Overload Protection	1.4 A	
Short-circuit Protection	Yes	
Power-on Value	Yes, Programmable	
Safe Value	Yes, Programmable	

Pin Assignments

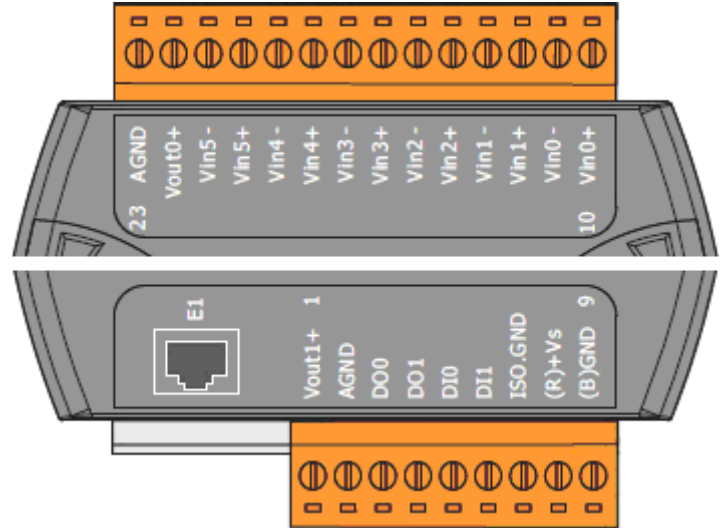

Voltage/Current Input Selection Jumper Settings

Remove the top case of the module.

Channel	Vout0 & AGND	Vin5 ±	Vin4 ±	Vin3 ±	Vin2 ±	Vin1 ±	Vin0 ±
Jumper	JP5	J6	J5	J4	J3	J2	JP1

The selection jumpers are next to the connector. Refer to the table below to set the input type.

Channel	Vout1+ & AGND
Jumper	JP6

Voltage Input	Current Input	Voltage Output	Current Output

Tips & Warnings



The jumper settings of the input type for each AI/AO channel must correspond to the input range for each AI/AO channel of the web interface.

Analog Output Settings Basic Settings

Channel	Range (40459)
Ch0	32.0 V ~ 10 V
Ch1	32.0 V ~ 10 V

Analog Input Settings Basic Settings

Channel	Range (40427)
Ch0	08.10 V ~ 10 V
Ch1	08.10 V ~ 10 V
Ch2	08.10 V ~ 10 V
Ch3	08.10 V ~ 10 V
Ch4	08.10 V ~ 10 V
Ch5	08.10 V ~ 10 V

Wire Connections

Digital Input/Counter	ON State Readback as 1	OFF State Readback as 0	Digital Output	ON State Readback as 1	OFF State Readback as 0
Dry Contact			Open Collector (Sink)		

Modbus Register Table

Coils (0xxxx)

Register		Points	Description	Data Format	Attribute	Factory Value
DEC	HEX					
0000 : 0001	0000 : 0001	2	DO value	0: Off 1: On	R/W	-
00034 : 00035	0022 : 0023	2	Clear the DI counter value	1: Clear	W	-
00130 : 00131	0082 : 0083	2	Clear the DI latched value	1: Clear	W	-
00162 : 00167	00A2 : 00A7	6	Clear 1-ch historical AI max. value	1: Clear	W	-
00194 : 00199	00C2 : 00C7	6	Clear 1-ch historical AI min. value	1: Clear	W	-
00226	00E2	1	Reset the I/O settings to the factory default state	1: Reset	W	-
00233	00E9	1	Reboot the module	1: Reboot	W	-
00350	015E	1	Enable/Disable the DI latch function	0: Disable 1: Enable	R/W/E	0
00351 : 00352	015F : 0160	2	Enable/Disable the DI counter function	0: Disable 1: Enable	R/W/E	0
00431	01AF	1	Save the DO power-on value to the EEPROM	1: Save	W/E	-
00432	01B0	1	Save the DO safe value to the EEPROM	1: Save	W/E	-
00435 : 00436	01B3 : 01B4	2	Enable/Disable the DO power-on value function	0: Disable 1: Enable	R/W	0
00515 : 00516	0203 : 0204	2	Enable/Disable the DO safe value function	0: Disable 1: Enable	R/W	0
00595 : 00560	0253 : 0258	6	Enable/Disable the AI function	0: Disable 1: Enable	R/W/E	1
00628	0274	1	Set the AI sampling rate	0: Normal mode (10 Hz, 16 bits) 1: Fast mode (60 Hz, 12 bits)	R/W/E	0
00629	0275	1	Set the AI noise filter	0: Frequency 60 Hz 1: Frequency 50 Hz	R/W/E	0
00630	0276	1	Save preset values for the DI counter to the EEPROM	1: Save	W/E	-
00631	0277	1	Set the AI/AO data format	0: Hexadecimal format 1: Engineering unit	R/W/E	0
00632	0278	1	Reset the AI calibration to the factory settings	1: Reset	W	-
00634	027A	1	Clear all historical AI max. values	1: Clear	W	-
00635	027B	1	Clear all historical AI min. values	1: Clear	W	-
00636 : 00641	027C : 0281	6	Enable/Disable the AI high alarm function	0: Disable 1: Enable	R/W/E	0
00668 : :	029C : :	6	Enable/Disable the AI low alarm function	0: Disable 1: Enable	R/W/E	0

ET-7000/PET-7000 Register Table, version 1.0.3

00670	02A1					
00700 : 00705	02BC : 02C1	6	Set the AI high alarm mode	0: Momentary mode 1: Latching mode	R/W/E	0
00732 : 00737	02DC : 02E1	6	Set the AI low alarm mode	0: Momentary mode 1: Latching mode	R/W/E	0
00764 : 00769	02FC : 0301	6	Clear the AI high alarm status	1: Clear	W	-
00796 : 00801	031C : 0321	6	Clear the AI high low status	1: Clear	W	-
00830	033E	1	Enable/Disable the AI calibration	0: Disable 1: Enable	R/W	-
00831	033F	1	Zero calibration for the channel 0	1: Set	W	-
00832	0340	1	Span calibration for the channel 0	1: Set	W	-

Discrete Inputs (1xxxx)

Register		Points	Description	Data Format	Attribute
DEC	HEX				
10000 : 10001	0000 : 0001	2	DI value	0: Off 1: On	R
10032 : 10033	0020 : 0021	2	Read DI "high latch" status	0: Normal 1: Latched	R
10064 : 10065	0040 : 0041	2	Read DI "low latch" status	0: Normal 1: Latched	R
10224 : 10229	00E0 : 00E5	6	Read AI high alarm status. When the AI value is higher than the high alarm value, the status becomes 1.	0: Normal 1: Alarmed	R
10256 : 10261	0100 : 0105	6	Read AI low alarm status. When the AI value is lower than the high alarm value, the status becomes 1.	0: Normal 1: Alarmed	R

Input Register (3xxxx)

Register		Points	No. Per Point	Description	Data Format	Attribute
DEC	HEX					
30000 : 30005	0000 : 0005	6	1	AI value	-32768 to 32767 (0x0000 to 0xFFFF)	R
30032 : 30035	0020 : 0023	2	2	DI counter value	0 to 4294967295	R
30236 : 30241	00EC : 00F1	6	1	AI historical max. value	-32768 to 32767 (0x0000 to 0xFFFF)	R
30268 : 30273	010C : 0111	6	1	AI historical min. value	-32768 to 32767 (0x0000 to 0xFFFF)	R
30300	012C	1	1	Number of the DI channel	6	R
30310	0136	1	1	Number of the DO channel	2	R
30320	0140	1	1	Number of the AI channel	2	R
30330	014A	1	1	Number of the AO channel	2	R
30350	015E	1	1	OS image version	0x123 means version 1.2.3	R
30351	015F	1	1	Firmware version	0x123 means version 1.2.3	R
30353	0161	1	1	I/O version	0x123 means version 1.2.3	R
30360	0168	1	1	Communication state of the pair-connection	0: Normal <0: Failed	R

Holding Register (4xxxx)

Register		Points	No. Per Point	Description	Data Format	Attribute	Factory Value
DEC	HEX						
40000 : 40001	0000 : 0001	2	1	AO value	-32768 to 32767 (0x0000 to 0xFFFF)	R/W	-
40200 : 40203	00C8 : 00CB	2	2	Set a preset value for the DI Counter Any values updated based on the Modbus communication will not take immediate effect and not be saved to EEPROM until the register (00630) is changed by a write operation.	0 to 4294967295	R/W	0
40271	010F	1	1	Set the module identification (Modbus NetID)	1 to 255	R/W/E	1
40296 : 40301	0128 : 012D	6	1	Set the AI high alarm value	-32768 to 32767 (0x0000 to 0xFFFF)	R/W/E	32767 (0x7FFF)
40328 : 40333	0148 : 014D	6	1	Set the AI low alarm value	-32768 to 32767 (0x0000 to 0xFFFF)	R/W/E	-32768 (0x8000)
40360 : 40361	0168 : 0169	2	1	Set the power-on value for the AO channel	-32768 to 32767 (0x0000 to 0xFFFF)	R/W/E	0
40392 : 40393	0188 : 0189	2	1	Set the safe value for the AO channel	-32768 to 32767 (0x0000 to 0xFFFF)	R/W/E	0
40427 : 40432	01AB : 01B0	6	1	Set the AI range	0x07: 4~20 mA 0x08: +/-10 V 0x09: +/-5 V 0x0A: +/-1 V 0x0B: +/-500 mV 0x0C: +/-150 mV 0x0D: +/-20 mA 0x1A: 0~20 mA	R/W/E	0x08
40459 : 40460	01CB : 01CC	2	1	Set the AO range	0x30: 0~20 mA 0x31: 4~20 mA 0x32: 0~10 V 0x33: +/-10 V 0x34: 0~5 V 0x35: +/-5 V	R/W/E	0x32
40523 : 40524	020B : 020C	2	1	Set the AO slew rate range	0x00: Immediate 0x01: 0.0625 V/sec or 0.125 mA/sec 0x02: 0.125 V/sec or 0.25 mA/sec 0x03: 0.25 V/sec or 0.5 mA/sec 0x04: 0.5 V/sec or 1.0 mA/sec 0x05: 1.0 V/sec or 2.0 mA/sec 0x06: 2.0 V/sec or 4.0 mA/sec 0x07: 4.0 V/sec or 8.0 mA/sec 0x08: 8.0 V/sec or 16 mA/sec 0x09: 16 V/sec or 32 mA/sec 0x10: 32 V/sec or 64 mA/sec 0x11: 64 V/sec or 128 mA/sec 0x12: 128 V/sec or 256 mA/sec 0x13: 256 V/sec or 512 mA/sec 0x14: 512 V/sec or 1024 mA/sec	R/W/E	0x00

ET-7000/PET-7000 Register Table, version 1.0.3

40555	022B	1	1	Read the module reset status	1: Power-on 2: Module Watchdog 3: Software Reset Command	R	-
40556	022C	1	1	Read the boot count of the module The factory default value is 0 when the settings are set to the factory default values.	1 to 32767	R	-
40557	022D	1	1	Set the Host WDT timeout (unit: second)	0: Disable the Host WDT 5 to 65535: Enable the Host WDT	R/W/E	0
40558	022E	1	1	Read the WDT event count The initial value is 0 when the module is reset, and is increased when the WDT even happens.	0 to 32767	R	-
40559	022F	1	1	Read the module name	0x7026	R	-

ET-7042/PET-7042

I/O Specifications

Model	ET-7042	PET-7042
Digital Output		
Output Channels	16	
Type	Isolated Open Collector (Sink)	
Max. Load Current	100 mA/Channel at 25°C Direct drive power relay module	
Load Voltage	+5 V _{DC} ~ +30 V _{DC}	
Overvoltage Protection	-	60 V _{DC}
Overload Protection	-	1.3 A
Short-circuit Protection	-	Yes
Power-on Value	Yes, Programmable	
Safe Value	Yes, Programmable	

Pin Assignments

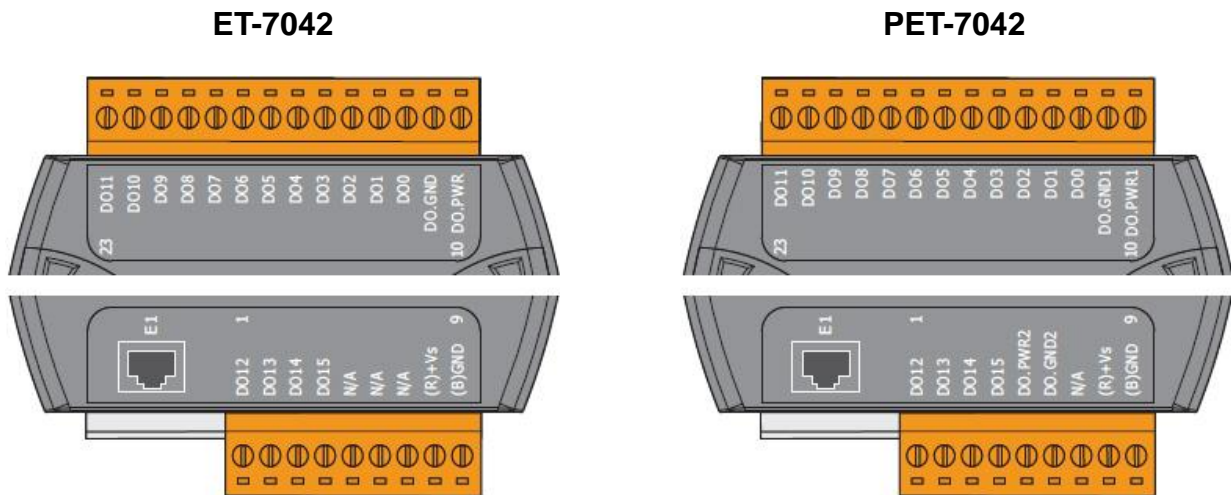

Wire Connection

Digital Output	ON State Readback as 1	OFF State Readback as 0
Drive Relay		
Resistance Load		

Modbus Register Table

Coils (0xxxx)

Register		Points	Description	Data Format	Attribute	Factory Value
DEC	HEX					
00000 : 00015	0000 : 000F	16	DO value	0: Off 1: On	R/W	-
00126	007E	1	Reset the I/O settings to the factory default state	1: Reset	W	-
00133	0085	1	Reboot the module	1: Reboot	W	-
00231	00E7	1	Save the DO power-on value to the EEPROM	1: Save	W/E	-
00232	00E8	1	Save the DO safe value to the EEPROM	1: Save	W/E	-
00235 : 00250	00EB : 00FA	16	Enable/Disable the DO power-on value function	0: Disable 1: Enable	R/W	0
00267 : 00282	010B : 011A	16	Enable/Disable the DO safe value function	0: Disable 1: Enable	R/W	0

Input Register (3xxxx)

Register		Points	No. Per Point	Description	Data Format	Attribute
DEC	HEX					
30110	006E	1	1	Number of the DO channel	16	R
30150	0096	1	1	OS image version	0x123 means version 1.2.3	R
30151	0097	1	1	Firmware version	0x123 means version 1.2.3	R
30153	0099	1	1	I/O version	0x123 means version 1.2.3	R
30160	00A0	1	1	Communication state of the pair-connection	0: Normal <0: Failed	R

Holding Register (4xxxx)

Register		Points	No. Per Point	Description	Data Format	Attribute	Factory Value
DEC	HEX						
40255	00FF	1	1	Read the module reset status	1: Power-on 2: Module Watchdog 3: Software Reset Command	R	-
40256	0100	1	1	Read the boot count of the module The factory default value is 0 when the settings are set to the factory default values.	1 to 32767	R	-
40257	0101	1	1	Set the Host WDT timeout (unit: second)	0: Disable the Host WDT 5 to 65535: Enable the Host WDT	R/W/E	0
40258	0102	1	1	Read the WDT event count The initial value is 0 when the module is reset, and is increased when the WDT even happens.	0 to 32767	R	-
40260	0104	1	1	Read the module name	0x7042	R	-
40271	010F	1	1	Set the module identification (Modbus NetID)	1 to 255	R/W/E	1

ET-7044/PET-7044

I/O Specifications

Digital Input/Counter		
Input Channels	8	
Type	Wet Contact (Sink, Source)	
On Voltage Level	+10 VDC ~ +50VDC	
Off Voltage Level	+4 VDC max.	
Input Impedance	10 KΩ	
Counter	Channels	8
	Max. Count	4,294,967,285 (32-bit)
	Max. Input Frequency	500 Hz
	Min. Pulse Width	1 ms
Overvoltage Protection	70 VDC	
Digital Output		
Output Channels	8	
Type	Isolated Open Collector (Sink)	
Max. Load Current	300 mA/Channel at 25°C	
Load Voltage	+10 VDC ~ +40 VDC	
Overvoltage Protection	60 VDC	
Overload Protection	1.1 A	
Short-circuit Protection	Yes	
Power On Value	Yes, Programmable	
Safe Value	Yes, Programmable	

Pin Assignments

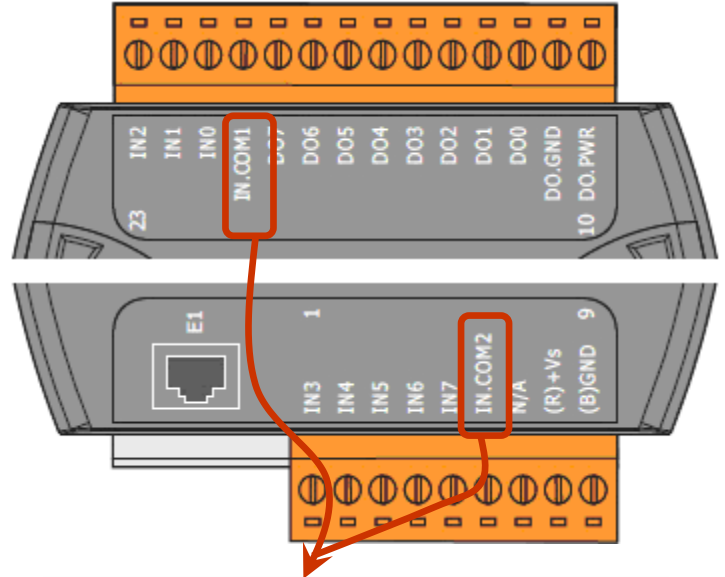

The IN.COM1 and IN.COM2 of the ET-7044 are internally wired together. But in the PET-7044, they are separate.

Wire Connections

Digital Input/Counter	Readback as 1 +10 ~ +50 V _{DC}	Readback as 0 Open or <4 V _{DC}
Sink		
Source		

Digital Output	ON State Readback as 1	OFF State Readback as 0
Drive Relay		
Resistance Load		

Modbus Register Table

Coils (0xxxx)

Register		Points	Description	Data Format	Attribute	Factory Value
DEC	HEX					
0000 : 0007	0000 : 0007	8	DO value	0: Off 1: On	R/W	-
00032	0020	1	Clear 1-ch historical DI max. value	1: Clear	W	-
00033	0021	1	Clear 1-ch historical DI min. value	1: Clear	W	-
00034 : 00041	0022 : 0029	8	Clear the DI counter value	1: Clear	W	-
00126	007E	1	Reset the I/O settings to the factory default state	1: Reset	W	-
00133	0085	1	Reboot the module	1: Reboot	W	-
00150	0096	1	Enable/Disable the DI latch function	0: Disable 1: Enable	R/W/E	0
00151 : 00158	0097 : 009E	8	Enable/Disable the DI counter function	0: Disable 1: Enable	R/W/E	0
00231	00E7	1	Save the DO power-on value to the EEPROM	1: Save	W/E	-
00232	00E8	1	Save the DO safe value to the EEPROM	1: Save	W/E	-
00235 : 00242	00EB : 00F2	8	Enable/Disable the DO power-on value function	0: Disable 1: Enable	R/W	0
00267 : 00274	010B : 0112	8	Enable/Disable the DO safe value function	0: Disable 1: Enable	R/W	0
00318	013E	1	Save preset values for the DI counter to the EEPROM	1: Save	W/E	-

Discrete Inputs (1xxxx)

Register		Points	Description	Data Format	Attribute
DEC	HEX				
10000 : 10007	0000 : 0007	8	DI value	0: Off 1: On	R
10032 : 10039	0020 : 0027	8	Read DI "high latch" status	0: Normal 1: Latched	R
10064 : 10071	0040 : 0047	8	Read DI "low latch" status	0: Normal 1: Latched	R

Input Register (3xxxx)

Register		Points	No. Per Point	Description	Data Format	Attribute
DEC	HEX					
30016 : 30031	0010 : 001F	8	2	DI counter value	0 to 4294967295	R
30100	0064	1	1	Number of the DI channel	8	R
30110	006E	1	1	Number of the DO channel	8	R
30150	0096	1	1	OS image version	0x123 means version 1.2.3	R
30151	0097	1	1	Firmware version	0x123 means version 1.2.3	R
30153	0099	1	1	I/O version	0x123 means version 1.2.3	R
30160	00A0	1	1	Communication state of the pair-connection	0: Normal <0: Failed	R

Holding Register (4xxxx)

Register		Points	No. Per Point	Description	Data Format	Attribute	Factory Value
DEC	HEX						
40050 : 40065	0032 : 0041	8	2	Set a preset value for the DI Counter Any values updated based on the Modbus communication will not take immediate effect and not be saved to EEPROM until the register (00318) is changed by a write operation.	0 to 4294967295	R/W	0
40255	00FF	1	1	Read the module reset status	1: Power-on 2: Module Watchdog 3: Software Reset Command	R	-
40256	0100	1	1	Read the boot count of the module The factory default value is 0 when the settings are set to the factory default values.	1 to 32767	R	-
40257	0101	1	1	Set the Host WDT timeout (unit: second)	0: Disable the Host WDT 5 to 65535: Enable the Host WDT	R/W/E	0
40258	0102	1	1	Read the WDT event count The initial value is 0 when the module is reset, and is increased when the WDT even happens.	0 to 32767	R	-
40260	0104	1	1	Read the module name	0x7044	R	-
40271	010F	1	1	Set the module identification (Modbus NetID)	1 to 255	R/W/E	1

ET-7050/PET-7050

I/O Specifications

Model		ET-7050	PET-7050
Digital Input/Counter			
Input Channels		12	
Type		Wet Contact (Sink, Source)	
On Voltage Level		+10 VDC ~ +50VDC	
Off Voltage Level		+4 VDC max.	
Input Impedance		10 KΩ	
Counter	Channels	12	
	Max. Count	4,294,967,285 (32-bit)	
	Max. Input Frequency	500 Hz	
	Min. Pulse Width	1 ms	
Overvoltage Protection		70 VDC	
Digital Output			
Output Channels		6	
Type		Isolated Open Collector (Sink)	
Max. Load Current		100 mA/Channel at 25°C Direct drive power relay module	
Load Voltage		+5 VDC ~ +30 VDC	
Overvoltage Protection		-	60 VDC
Overload Protection		-	1.3 A
Short-circuit Protection		-	Yes
Power-on Value		Yes, Programmable	
Safe Value		Yes, Programmable	

Pin Assignments

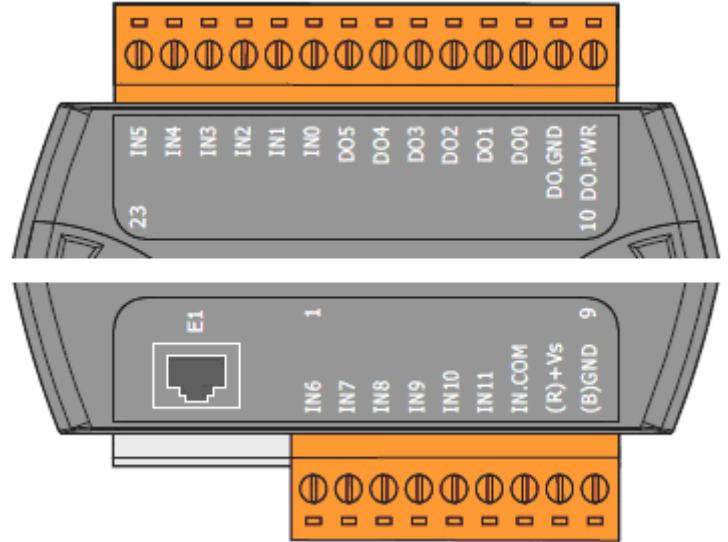

Wire Connections

Digital Input/Counter	Readback as 1 +10 ~ +50 V _{DC}	Readback as 0 Open or <4 V _{DC}
Sink		
Source		

Digital Output	ON State Readback as 1	OFF State Readback as 0
Drive Relay		
Resistance Load		

Modbus Register Table

Coils (0xxxx)

Register		Points	Description	Data Format	Attribute	Factory Value
DEC	HEX					
00000 : 00005	0000 : 0005	6	DO value	0: Off 1: On	R/W	-
00032	0020	1	Clear 1-ch historical DI max. value	1: Clear	W	-
00033	0021	1	Clear 1-ch historical DI min. value	1: Clear	W	-
00034 : 00045	0022 : 002D	12	Clear the DI counter value	1: Clear	W	-
00126	007E	1	Reset the I/O settings to the factory default state	1: Reset	W	-
00133	0085	1	Reboot the module	1: Reboot	W	-
00150	0096	1	Enable/Disable the DI latch function	0: Disable 1: Enable	R/W/E	0
00151 : 00162	0097 : 00A2	12	Enable/Disable the DI counter function	0: Disable 1: Enable	R/W/E	0
00231	00E7	1	Save the DO power-on value to the EEPROM	1: Save	W/E	-
00232	00E8	1	Save the DO safe value to the EEPROM	1: Save	W/E	-
00235 : 00240	00EB : 00F0	6	Enable/Disable the DO power-on value function	0: Disable 1: Enable	R/W	0
00267 : 00272	010B : 0110	6	Enable/Disable the DO safe value function	0: Disable 1: Enable	R/W	0
00318	013E	1	Save preset values for the DI counter to the EEPROM	1: Save	W/E	-

Discrete Inputs (1xxxx)

Register		Points	Description	Data Format	Attribute
DEC	HEX				
10000 : 10011	0000 : 000B	12	DI value	0: Off 1: On	R
10032 : 10043	0020 : 002B	12	Read DI "high latch" status	0: Normal 1: Latched	R
10064 : 10075	0040 : 004B	12	Read DI "low latch" status	0: Normal 1: Latched	R

Input Register (3xxxx)

Register		Points	No. Per Point	Description	Data Format	Attribute
DEC	HEX					
30016 : 30039	0010 : 0027	12	2	DI counter value	0 to 4294967295	R
30100	0064	1	1	Number of the DI channel	12	R
30110	006E	1	1	Number of the DO channel	6	R
30150	0096	1	1	OS image version	0x123 means version 1.2.3	R
30151	0097	1	1	Firmware version	0x123 means version 1.2.3	R
30153	0099	1	1	I/O version	0x123 means version 1.2.3	R
30160	00A0	1	1	Communication state of the pair-connection	0: Normal <0: Failed	R

Holding Register (4xxxx)

Register		Points	No. Per Point	Description	Data Format	Attribute	Factory Value
DEC	HEX						
40050 : 40073	0032 : 0049	12	2	Set a preset value for the DI Counter Any values updated based on the Modbus communication will not take immediate effect and not be saved to EEPROM until the register (00318) is changed by a write operation.	0 to 4294967295	R/W	0
40255	00FF	1	1	Read the module reset status	1: Power-on 2: Module Watchdog 3: Software Reset Command	R	-
40256	0100	1	1	Read the boot count of the module The factory default value is 0 when the settings are set to the factory default values.	1 to 32767	R	-
40257	0101	1	1	Set the Host WDT timeout (unit: second)	0: Disable the Host WDT 5 to 65535: Enable the Host WDT	R/W/E	0
40258	0102	1	1	Read the WDT event count The initial value is 0 when the module is reset, and is increased when the WDT even happens.	0 to 32767	R	-
40260	0104	1	1	Read the module name	0x7050	R	-
40271	010F	1	1	Set the module identification (Modbus NetID)	1 to 255	R/W/E	1

ET-7051/PET-7051

I/O Specifications

Digital Input/Counter		
Input Channels	16	
Type	Wet Contact (Sink, Source)	
On Voltage Level	+10 VDC ~ +50VDC	
Off Voltage Level	+4 VDC max.	
Input Impedance	10 KΩ	
Counter	Channels	16
	Max. Count	4,294,967,285 (32-bit)
	Max. Input Frequency	500 Hz
	Min. Pulse Width	1 ms
Overvoltage Protection	70 VDC	

Pin Assignments

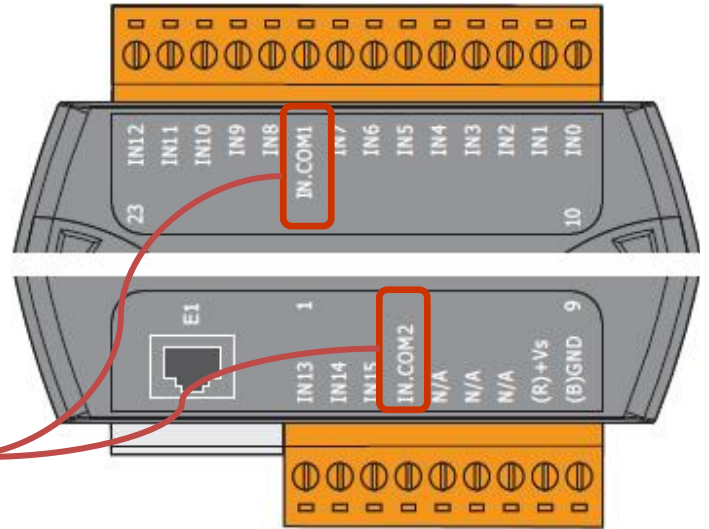

The IN.COM1 and IN.COM2 of the ET-7051 are internally wired together. But in the PET-7051, they are separate.

Wire Connections

Digital Input/Counter	Readback as 1 +10 ~ +50 V _{DC}	Readback as 0 Open or <4 V _{DC}
Sink		
Source		

Modbus Register Table

Coils (0xxxx)

Register		Points	Description	Data Format	Attribute	Factory Value
DEC	HEX					
00032	0020	1	Clear 1-ch historical DI max. value	1: Clear	W	-
00033	0021	1	Clear 1-ch historical DI min. value	1: Clear	W	-
00034 : 00049	0022 : 0031	16	Clear the DI counter value	1: Clear	W	-
00126	007E	1	Reset the I/O settings to the factory default state	1: Reset	W	-
00133	0085	1	Reboot the module	1: Reboot	W	-
00150	0096	1	Enable/Disable the DI latch function	0: Disable 1: Enable	R/W/E	0
00151 : 00166	0097 : 00A6	16	Enable/Disable the DI counter function	0: Disable 1: Enable	R/W/E	0
00318	013E	1	Save preset values for the DI counter to the EEPROM	1: Save	W/E	-

Input Register (3xxxx)

Register		Points	No. Per Point	Description	Data Format	Attribute
DEC	HEX					
30016 : 30047	0010 : 002F	16	2	DI counter value	0 to 4294967295	R
30100	0064	1	1	Number of the DI channel	16	R
30150	0096	1	1	OS image version	0x123 means version 1.2.3	R
30151	0097	1	1	Firmware version	0x123 means version 1.2.3	R
30153	0099	1	1	I/O version	0x123 means version 1.2.3	R

Holding Register (4xxxx)

Register		Points	No. Per Point	Description	Data Format	Attribute	Factory Value
DEC	HEX						
40050 : 40081	0032 : 0051	16	2	Set a preset value for the DI Counter Any values updated based on the Modbus communication will not take immediate effect and not be saved to EEPROM until the register (00318) is changed by a write operation.	0 to 4294967295	R/W	0
40255	00FF	1	1	Read the module reset status	1: Power-on 2: Module Watchdog 3: Software Reset Command	R	-
40256	0100	1	1	Read the boot count of the module The factory default value is 0 when the settings are set to the factory default values.	1 to 32767	R	-
40257	0101	1	1	Set the Host WDT timeout (unit: second)	0: Disable the Host WDT 5 to 65535: Enable the Host WDT	R/W/E	0
40258	0102	1	1	Read the WDT event count The initial value is 0 when the module is reset, and is increased when the WDT even happens.	0 to 32767	R	-
40260	0104	1	1	Read the module name	0x7051	R	-
40271	010F	1	1	Set the module identification (Modbus NetID)	1 to 255	R/W/E	1

ET-7052/PET-7052

I/O Specifications

Digital Input/Counter		
Input Channels	8	
Type	Wet Contact (Sink, Source)	
On Voltage Level	+10 VDC ~ +50VDC	
Off Voltage Level	+4 VDC max.	
Input Impedance	10 KΩ	
Counter	Channels	8
	Max. Count	4,294,967,285 (32-bit)
	Max. Input Frequency	500 Hz
	Min. Pulse Width	1 ms
Overvoltage Protection	70 VDC	
Digital Output		
Output Channels	8	
Type	Open Collector (Source)	
Max. Load Current	650 mA/Channel at 25°C	
Load Voltage	+10 VDC ~ +40 VDC	
Overvoltage Protection	47 VDC	
Overload Protection	-	
Short-circuit Protection	Yes	
Power-on Value	Yes, Programmable	
Safe Value	Yes, Programmable	

Pin Assignments

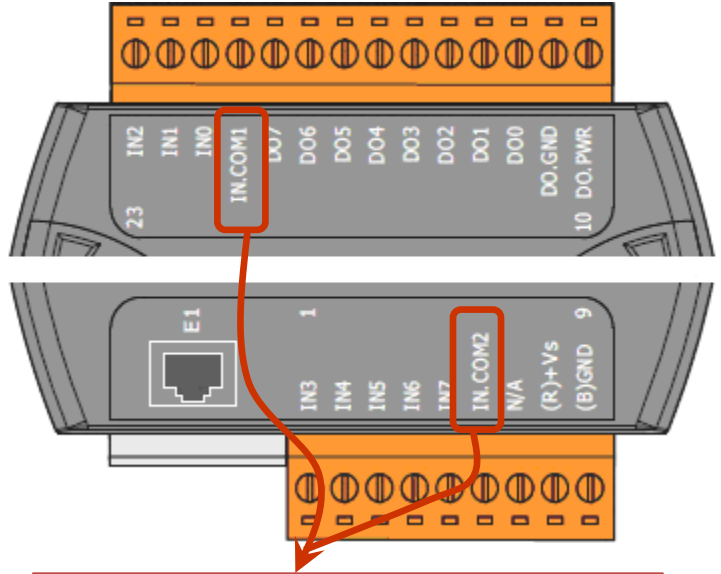

The IN.COM1 and IN.COM2 of the ET-7052 are internally wired together. But in the PET-7052, they are separate.

Wire Connections

Digital Input/Counter	Readback as 1	Readback as 0
Sink	+10 ~ +50 V _{DC} 	Open or <4 V _{DC}
	Source	+10 ~ +50 VDC

Digital Output	ON State Readback as 1	OFF State Readback as 0
Source		

Modbus Register Table

Coils (0xxxx)

Register		Points	Description	Data Format	Attribute	Factory Value
DEC	HEX					
0000 : 0007	0000 : 0007	8	DO value	0: Off 1: On	R/W	-
00032	0020	1	Clear 1-ch historical DI max. value	1: Clear	W	-
00033	0021	1	Clear 1-ch historical DI min. value	1: Clear	W	-
00034 : 00041	0022 : 0029	8	Clear the DI counter value	1: Clear	W	-
00126	007E	1	Reset the I/O settings to the factory default state	1: Reset	W	-
00133	0085	1	Reboot the module	1: Reboot	W	-
00150	0096	1	Enable/Disable the DI latch function	0: Disable 1: Enable	R/W/E	0
00151 : 00158	0097 : 009E	8	Enable/Disable the DI counter function	0: Disable 1: Enable	R/W/E	0
00231	00E7	1	Save the DO power-on value to the EEPROM	1: Save	W/E	-
00232	00E8	1	Save the DO safe value to the EEPROM	1: Save	W/E	-
00235 : 00242	00EB : 00F2	8	Enable/Disable the DO power-on value function	0: Disable 1: Enable	R/W	0
00267 : 00274	010B : 0112	8	Enable/Disable the DO safe value function	0: Disable 1: Enable	R/W	0
00318	013E	1	Save preset values for the DI counter to the EEPROM	1: Save	W/E	-

Discrete Inputs (1xxxx)

Register		Points	Description	Data Format	Attribute
DEC	HEX				
10000 : 10007	0000 : 0007	8	DI value	0: Off 1: On	R
10032 : 10039	0020 : 0027	8	Read DI "high latch" status	0: Normal 1: Latched	R
10064 : 10071	0040 : 0047	8	Read DI "low latch" status	0: Normal 1: Latched	R

Input Register (3xxxx)

Register		Points	No. Per Point	Description	Data Format	Attribute
DEC	HEX					
30016 : 30031	0010 : 001F	8	2	DI counter value	0 to 4294967295	R
30100	0064	1	1	Number of the DI channel	8	R
30110	006E	1	1	Number of the DO channel	8	R
30150	0096	1	1	OS image version	0x123 means version 1.2.3	R
30151	0097	1	1	Firmware version	0x123 means version 1.2.3	R
30153	0099	1	1	I/O version	0x123 means version 1.2.3	R
30160	00A0	1	1	Communication state of the pair-connection	0: Normal <0: Failed	R

Holding Register (4xxxx)

Register		Points	No. Per Point	Description	Data Format	Attribute	Factory Value
DEC	HEX						
40050 : 40065	0032 : 0041	8	2	Set a preset value for the DI Counter Any values updated based on the Modbus communication will not take immediate effect and not be saved to EEPROM until the register (00318) is changed by a write operation.	0 to 4294967295	R/W	0
40255	00FF	1	1	Read the module reset status	1: Power-on 2: Module Watchdog 3: Software Reset Command	R	-
40256	0100	1	1	Read the boot count of the module The factory default value is 0 when the settings are set to the factory default values.	1 to 32767	R	-
40257	0101	1	1	Set the Host WDT timeout (unit: second)	0: Disable the Host WDT 5 to 65535: Enable the Host WDT	R/W/E	0
40258	0102	1	1	Read the WDT event count The initial value is 0 when the module is reset, and is increased when the WDT even happens.	0 to 32767	R	-
40260	0104	1	1	Read the module name	0x7052	R	-
40271	010F	1	1	Set the module identification (Modbus NetID)	1 to 255	R/W/E	1

ET-7053/PET-7053

I/O Specifications

Digital Input/Counter		
Input Channels	16	
Type	Dry Contact (Source)	
On Voltage Level	Open	
Off Voltage Level	Close to GND	
Counter	Channels	16
	Max. Count	4,294,967,285 (32-bit)
	Max. Input Frequency	500 Hz
	Min. Pulse Width	1 ms
Overtoltage Protection	-	
Effective Distance	500 M max.	

Pin Assignments

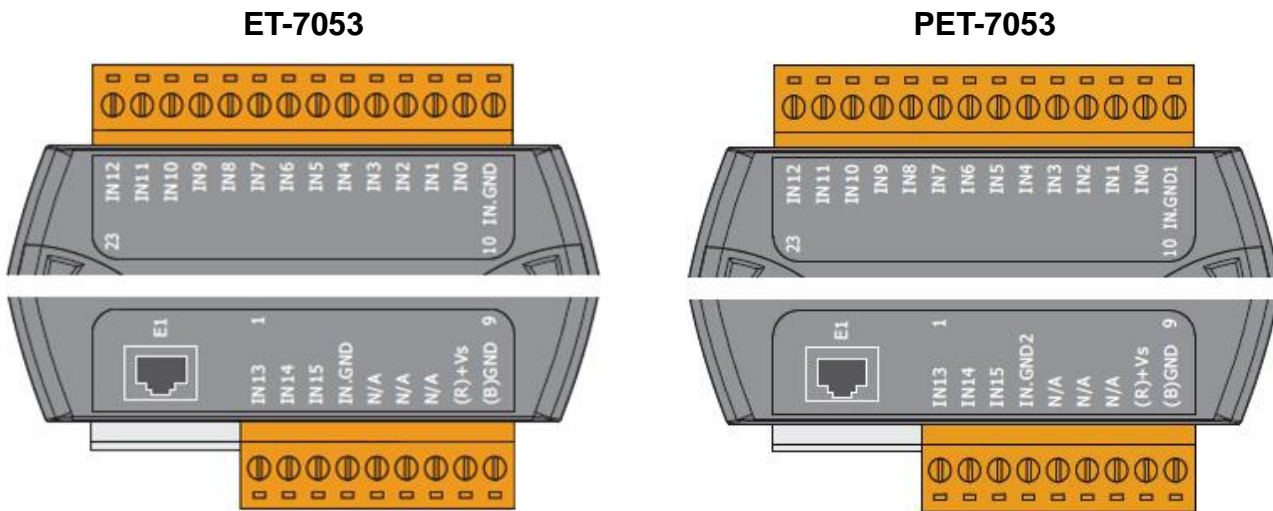

Wire Connections

Digital Input/Counter	ON State Readback as 1	OFF State Readback as 0
Dry Contact		

Modbus Register Table

Coils (0xxxx)

Register		Points	Description	Data Format	Attribute	Factory Value
DEC	HEX					
00032	0020	1	Clear 1-ch historical DI max. value	1: Clear	W	-
00033	0021	1	Clear 1-ch historical DI min. value	1: Clear	W	-
00034 : 00049	0022 : 0031	16	Clear the DI counter value	1: Clear	W	-
00126	007E	1	Reset the I/O settings to the factory default state	1: Reset	W	-
00133	0085	1	Reboot the module	1: Reboot	W	-
00150	0096	1	Enable/Disable the DI latch function	0: Disable 1: Enable	R/W/E	0
00151 : 00166	0097 : 00A6	16	Enable/Disable the DI counter function	0: Disable 1: Enable	R/W/E	0
00318	013E	1	Save preset values for the DI counter to the EEPROM	1: Save	W/E	-

Discrete Inputs (1xxxx)

Register		Points	Description	Data Format	Attribute
DEC	HEX				
10000 : 10015	0000 : 000F	16	DI value	0: Off 1: On	R
10032 : 10047	0020 : 002F	16	Read DI "high latch" status	0: Normal 1: Latched	R
10064 : 10079	0040 : 004F	16	Read DI "low latch" status	0: Normal 1: Latched	R

Input Register (3xxxx)

Register		Points	No. Per Point	Description	Data Format	Attribute
DEC	HEX					
30016 : 30047	0010 : 002F	16	2	DI counter value	0 to 4294967295	R
30100	0064	1	1	Number of the DI channel	16	R
30150	0096	1	1	OS image version	0x123 means version 1.2.3	R
30151	0097	1	1	Firmware version	0x123 means version 1.2.3	R
30153	0099	1	1	I/O version	0x123 means version 1.2.3	R

Holding Register (4xxxx)

Register		Points	No. Per Point	Description	Data Format	Attribute	Factory Value
DEC	HEX						
40050 : 40081	0032 : 0051	16	2	Set a preset value for the DI Counter Any values updated based on the Modbus communication will not take immediate effect and not be saved to EEPROM until the register (00318) is changed by a write operation.	0 to 4294967295	R/W	0
40255	00FF	1	1	Read the module reset status	1: Power-on 2: Module Watchdog 3: Software Reset Command	R	-
40256	0100	1	1	Read the boot count of the module The factory default value is 0 when the settings are set to the factory default values.	1 to 32767	R	-
40257	0101	1	1	Set the Host WDT timeout (unit: second)	0: Disable the Host WDT 5 to 65535: Enable the Host WDT	R/W/E	0
40258	0102	1	1	Read the WDT event count The initial value is 0 when the module is reset, and is increased when the WDT even happens.	0 to 32767	R	-
40260	0104	1	1	Read the module name	0x7053	R	-
40271	010F	1	1	Set the module identification (Modbus NetID)	1 to 255	R/W/E	1

ET-7060/PET-7060

I/O Specifications

Digital Input/Counter		
Input Channels	6	
Type	Wet Contact (Sink, Source)	
On Voltage Level	+10 VDC ~ +50VDC	
Off Voltage Level	+4 VDC max.	
Input Impedance	10 KΩ	
Counter	Channels	6
	Max. Count	4,294,967,285 (32-bit)
	Max. Input Frequency	500 Hz
	Min. Pulse Width	1 ms
Overvoltage Protection	70 VDC	
Power Relay		
Output Channels	6	
Type	Power Relay, Form A (SPST N.O.)	
Operating Voltage Range	250 VAC/30VDC	
Max. Load Current	5.0 A/channel at 25°C	
Operate Time	6 ms (Typical)	
Release Time	3 ms (Typical)	
Electrical Life (Resistive Load)	VDE:	5A @ 250 VAC 30,000 ops (10 ops/minute) at 75°C
		5A @ 30 VAC 70,000 ops (10 ops/minute) at 75°C
	UL:	5A @ 250 VAC/30 VDC 6,000 ops
		3A @ 250 VAC/30 VDC 100,000 ops
Mechanical Life	20,000,000 ops. at no load (300 ops/minute)	
Power-on Value	Yes, Programmable	
Safe Value	Yes, Programmable	

Pin Assignments

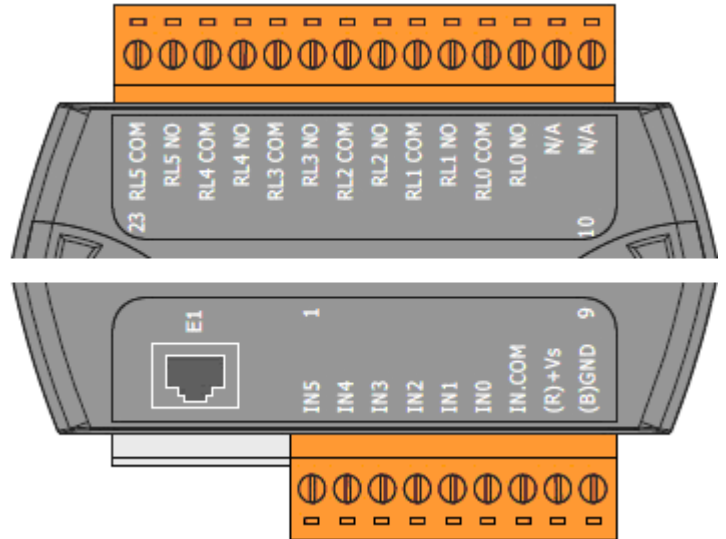

Wire Connections

Digital Input/Counter	Readback as 1	Readback as 0
Sink	+10 ~ +50 V _{DC} 	Open or <4 V _{DC}
	Source	+10 ~ +50 V _{DC}

Power Relay	ON State Readback as 1	OFF State Readback as 0
Relay Output		

Modbus Register Table

Coils (0xxxx)

Register		Points	Description	Data Format	Attribute	Factory Value
DEC	HEX					
00000 : 00005	0000 : 0005	6	DO value	0: Off 1: On	R/W	-
00032	0020	1	Clear 1-ch historical DI max. value	1: Clear	W	-
00033	0021	1	Clear 1-ch historical DI min. value	1: Clear	W	-
00034 : 00039	0022 : 0027	6	Clear the DI counter value	1: Clear	W	-
00126	007E	1	Reset the I/O settings to the factory default state	1: Reset	W	-
00133	0085	1	Reboot the module	1: Reboot	W	-
00150	0096	1	Enable/Disable the DI latch function	0: Disable 1: Enable	R/W/E	0
00151 : 00156	0097 : 009C	6	Enable/Disable the DI counter function	0: Disable 1: Enable	R/W/E	0
00231	00E7	1	Save the DO power-on value to the EEPROM	1: Save	W/E	-
00232	00E8	1	Save the DO safe value to the EEPROM	1: Save	W/E	-
00235 : 00240	00EB : 00F0	6	Enable/Disable the DO power-on value function	0: Disable 1: Enable	R/W	0
00267 : 00272	010B : 0110	6	Enable/Disable the DO safe value function	0: Disable 1: Enable	R/W	0
00318	013E	1	Save preset values for the DI counter to the EEPROM	1: Save	W/E	-

Discrete Inputs (1xxxx)

Register		Points	Description	Data Format	Attribute
DEC	HEX				
10000 : 10005	0000 : 0005	6	DI value	0: Off 1: On	R
10032 : 10037	0020 : 0025	6	Read DI "high latch" status	0: Normal 1: Latched	R
10064 : 10069	0040 : 0045	6	Read DI "low latch" status	0: Normal 1: Latched	R

Input Register (3xxxx)

Register		Points	No. Per Point	Description	Data Format	Attribute
DEC	HEX					
30016 :	0010 :	6	2	DI counter value	0 to 4294967295	R
30027	001B					
30100	0064	1	1	Number of the DI channel	6	R
30110	006E	1	1	Number of the DO channel	6	R
30150	0096	1	1	OS image version	0x123 means version 1.2.3	R
30151	0097	1	1	Firmware version	0x123 means version 1.2.3	R
30153	0099	1	1	I/O version	0x123 means version 1.2.3	R
30160	00A0	1	1	Communication state of the pair-connection	0: Normal <0: Failed	R

Holding Register (4xxxx)

Register		Points	No. Per Point	Description	Data Format	Attribute	Factory Value
DEC	HEX						
40050 :	0032 :	6	2	Set a preset value for the DI Counter Any values updated based on the Modbus communication will not take immediate effect and not be saved to EEPROM until the register (00318) is changed by a write operation.	0 to 4294967295	R/W	0
40061	003D						
40255	00FF	1	1	Read the module reset status	1: Power-on 2: Module Watchdog 3: Software Reset Command	R	-
40256	0100	1	1	Read the boot count of the module The factory default value is 0 when the settings are set to the factory default values.	1 to 32767	R	-
40257	0101	1	1	Set the Host WDT timeout (unit: second)	0: Disable the Host WDT 5 to 65535: Enable the Host WDT	R/W/E	0
40258	0102	1	1	Read the WDT event count The initial value is 0 when the module is reset, and is increased when the WDT even happens.	0 to 32767	R	-
40260	0104	1	1	Read the module name	0x7060	R	-
40271	010F	1	1	Set the module identification (Modbus NetID)	1 to 255	R/W/E	1

ET-7065

I/O Specifications

Digital Input/Counter		
Input Channels	6	
Type	Wet Contact (Sink, Source)	
On Voltage Level	+10 VDC ~ +50VDC	
Off Voltage Level	+4 VDC max.	
Input Impedance	10 K Ω	
Counter	Channels	6
	Max. Count	4,294,967,285 (32-bit)
	Max. Input Frequency	500 Hz
	Min. Pulse Width	1 ms
Overvoltage Protection	70 VDC	
PhotoMOS Relay		
Output Channels	6	
Type	PhotoMOS Relay, Form A	
Load Voltage	60 VDC/VAC	
Max. Load Current	60 V/1.0 A (Operating Temperature -25°C ~ 40°C)	
	60 V/0.8 A (Operating Temperature 40°C ~ 60°C)	
	60 V/0.7 A (Operating Temperature 60°C ~ 75°C)	
Operate Time	1.3 ms (Typical)	
Release Time	0.1 ms (Typical)	
Power-on Value	Yes, Programmable	
Safe Value	Yes, Programmable	

Pin Assignments

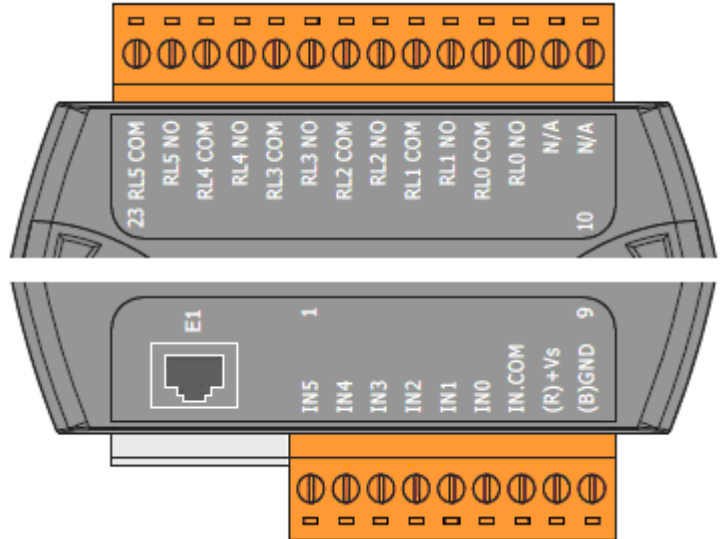

Wire Connections

Digital Input/Counter	Readback as 1	Readback as 0
Sink	+10 ~ +50 V _{DC} 	Open or <4 V _{DC}
	Source	+10 ~ +50 V _{DC}

PhotoMOS Relay	ON State Readback as 1	OFF State Readback as 0
Form A Relay Contact		

Modbus Register Table

Coils (0xxxx)

Register		Points	Description	Data Format	Attribute	Factory Value
DEC	HEX					
00000 : 00005	0000 : 0005	6	DO value	0: Off 1: On	R/W	-
00032	0020	1	Clear 1-ch historical DI max. value	1: Clear	W	-
00033	0021	1	Clear 1-ch historical DI min. value	1: Clear	W	-
00034 : 00039	0022 : 0027	6	Clear the DI counter value	1: Clear	W	-
00126	007E	1	Reset the I/O settings to the factory default state	1: Reset	W	-
00133	0085	1	Reboot the module	1: Reboot	W	-
00150	0096	1	Enable/Disable the DI latch function	0: Disable 1: Enable	R/W/E	0
00151 : 00156	0097 : 009C	6	Enable/Disable the DI counter function	0: Disable 1: Enable	R/W/E	0
00231	00E7	1	Save the DO power-on value to the EEPROM	1: Save	W/E	-
00232	00E8	1	Save the DO save value to the EEPROM	1: Save	W/E	-
00235 : 00240	00EB : 00F0	6	Enable/Disable the DO power-on value function	0: Disable 1: Enable	R/W	0
00267 : 00272	010B : 0110	6	Enable/Disable the DO safe value function	0: Disable 1: Enable	R/W	0
00318	013E	1	Save preset values for the DI counter to the EEPROM	1: Save	W/E	-

Discrete Inputs (1xxxx)

Register		Points	Description	Data Format	Attribute
DEC	HEX				
10000 : 1005	0000 : 0005	6	DI value	0: Off 1: On	R
10032 : 10037	0020 : 0025	6	Read DI "high latch" status	0: Normal 1: Latched	R
10064 : 10069	0040 : 0045	6	Read DI "low latch" status	0: Normal 1: Latched	R

Input Register (3xxxx)

Register		Points	No. Per Point	Description	Data Format	Attribute
DEC	HEX					
30016 : 30027	0010 : 001B	6	2	DI counter value	0 to 4294967295	R
30100	0064	1	1	Number of the DI channel	6	R
30110	006E	1	1	Number of the DO channel	6	R
30150	0096	1	1	OS image version	0x123 means version 1.2.3	R
30151	0097	1	1	Firmware version	0x123 means version 1.2.3	R
30153	0099	1	1	I/O version	0x123 means version 1.2.3	R
30160	00A0	1	1	Communication state of the pair-connection	0: Normal <0: Failed	R

Holding Register (4xxxx)

Register		Points	No. Per Point	Description	Data Format	Attribute	Factory Value
DEC	HEX						
40050 : 40061	0032 : 003D	6	2	Set a preset value for the DI Counter Any values updated based on the Modbus communication will not take immediate effect and not be saved to EEPROM until the register (00318) is changed by a write operation.	0 to 4294967295	R/W	0
40255	00FF	1	1	Read the module reset status	1: Power-on 2: Module Watchdog 3: Software Reset Command	R	-
40256	0100	1	1	Read the boot count of the module The factory default value is 0 when the settings are set to the factory default values.	1 to 32767	R	-
40257	0101	1	1	Set the Host WDT timeout (unit: second)	0: Disable the Host WDT 5 to 65535: Enable the Host WDT	R/W/E	0
40258	0102	1	1	Read the WDT event count The initial value is 0 when the module is reset, and is increased when the WDT even happens.	0 to 32767	R	-
40260	0104	1	1	Read the module name	0x7065	R	-
40271	010F	1	1	Set the module identification (Modbus NetID)	1 to 255	R/W/E	1

ET-7066

I/O Specifications

PhotoMOS Relay	
Output Channels	8
Type	PhotoMOS Relay, Form A
Load Voltage	60 V _{DC} /V _{AC}
Max. Load Current	60 V/1.0 A (Operating Temperature -25°C ~ 40°C)
	60 V/0.8 A (Operating Temperature 40°C ~ 60°C)
	60 V/0.7 A (Operating Temperature 60°C ~ 75°C)
Operate Time	1.3 ms (Typical)
Release Time	0.1 ms (Typical)
Power-on Value	Yes, Programmable
Safe Value	Yes, Programmable

Pin Assignments

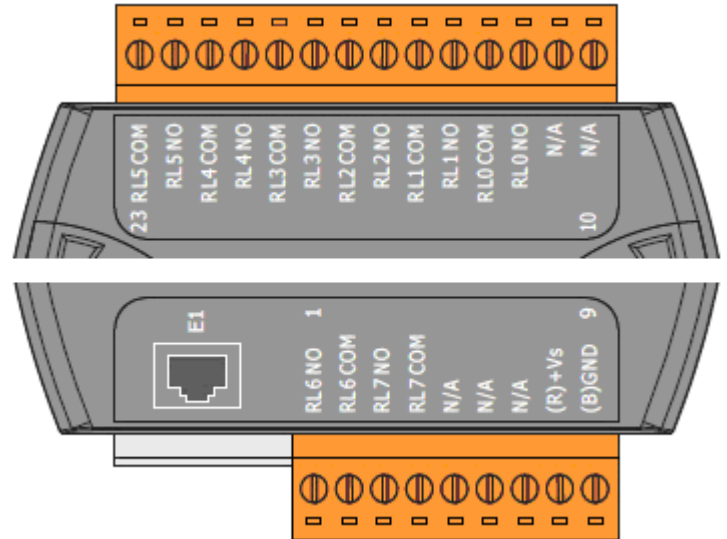

Wire Connections

PhotoMOS Relay	ON State Readback as 1	OFF State Readback as 0
Form A Relay Contact		

Modbus Register Table

Coils (0xxxx)

Register		Points	Description	Data Format	Attribute	Factory Value
DEC	HEX					
00000	0000	8	DO value	0: Off 1: On	R/W	-
:	:					
00007	0007					
00126	007E	1	Reset the I/O settings to the factory default state	1: Reset	W	-
00133	0085	1	Reboot the module	1: Reboot	W	-
00231	00E7	1	Save the DO power-on value to the EEPROM	1: Save	W/E	-
00232	00E8	1	Save the DO safe value to the EEPROM	1: Save	W/E	-
00235	00EB	8	Enable/Disable the DO power-on value function	0: Disable 1: Enable	R/W	0
:	:					
00242	00F2					
00267	010B	8	Enable/Disable the DO safe value function	0: Disable 1: Enable	R/W	0
:	:					
00274	0112					

Input Register (3xxxx)

Register		Points	No. Per Point	Description	Data Format	Attribute
DEC	HEX					
30110	006E	1	1	Number of the DO channel	8	R
30150	0096	1	1	OS image version	0x123 means version 1.2.3	R
30151	0097	1	1	Firmware version	0x123 means version 1.2.3	R
30153	0099	1	1	I/O version	0x123 means version 1.2.3	R
30160	00A0	1	1	Communication state of the pair-connection	0: Normal <0: Failed	R

Holding Register (4xxxx)

Register		Points	No. Per Point	Description	Data Format	Attribute	Factory Value
DEC	HEX						
40255	00FF	1	1	Read the module reset status	1: Power-on 2: Module Watchdog 3: Software Reset Command	R	-
40256	0100	1	1	Read the boot count of the module The factory default value is 0 when the settings are set to the factory default values.	1 to 32767	R	-
40257	0101	1	1	Set the Host WDT timeout (unit: second)	0: Disable the Host WDT 5 to 65535: Enable the Host WDT	R/W/E	0
40258	0102	1	1	Read the WDT event count The initial value is 0 when the module is reset, and is increased when the WDT even happens.	0 to 32767	R	-
40260	0104	1	1	Read the module name	0x7066	R	-
40271	010F	1	1	Set the module identification (Modbus NetID)	1 to 255	R/W/E	1

ET-7067/PET-7067

I/O Specifications

PhotoMOS Relay		
Output Channels	8	
Type	Power Relay, Form A (SPST N.O.)	
Operating Voltage Range	250 V _{AC} /30 V _{DC}	
Max. Load Current	5.0 A/Channel at 25°C	
Operate Time	6 ms (Typical)	
Release Time	3 ms (Typical)	
Electrical Life (Resistive Load)	VDE	5A @ 250 V _{AC} 30,000 ops (10 ops/minute) at 75°C
		5A @ 30 V _{AC} 70,000 ops (10 ops/minute) at 75°C
	UL	5A @ 250 V _{AC} /30 V _{DC} 6,000 ops
		3A @ 250 V _{AC} /30 V _{DC} 100,000 ops
Mechanical Life	20,000,000 ops. at no load (300 ops/minute)	
Power-on Value	Yes, Programmable	
Safe Value	Yes, Programmable	

Pin Assignments

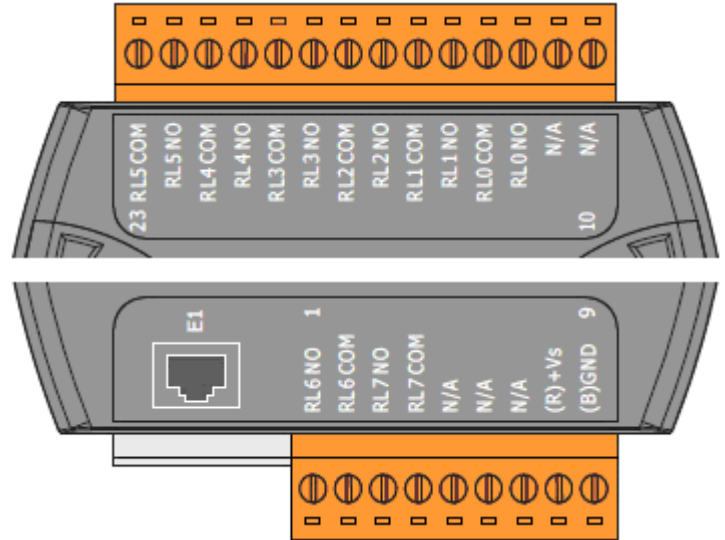

Wire Connections

Power Relay	ON State Readback as 1	OFF State Readback as 0
Relay Output		

Modbus Register Table

Coils (0xxxx)

Register		Points	Description	Data Format	Attribute	Factory Value
DEC	HEX					
00000 : 00007	0000 : 0007	8	DO value	0: Off 1: On	R/W	-
00126	007E	1	Reset the I/O settings to the factory default state	1: Reset	W	-
00133	0085	1	Reboot the module	1: Reboot	W	-
00231	00E7	1	Save the DO power-on value to the EEPROM	1: Save	W/E	-
00232	00E8	1	Save the DO safe value to the EEPROM	1: Save	W/E	-
00235 : 00242	00EB : 00F2	8	Enable/Disable the DO power-on value function	0: Disable 1: Enable	R/W	0
00267 : 00274	010B : 0112	8	Enable/Disable the DO safe value function	0: Disable 1: Enable	R/W	0

Input Register (3xxxx)

Register		Points	No. Per Point	Description	Data Format	Attribute
DEC	HEX					
30110	006E	1	1	Number of the DO channel	8	R
30150	0096	1	1	OS image version	0x123 means version 1.2.3	R
30151	0097	1	1	Firmware version	0x123 means version 1.2.3	R
30153	0099	1	1	I/O version	0x123 means version 1.2.3	R
30160	00A0	1	1	Communication state of the pair-connection	0: Normal <0: Failed	R

Holding Register (4xxxx)

Register		Points	No. Per Point	Description	Data Format	Attribute	Factory Value
DEC	HEX						
40255	00FF	1	1	Read the module reset status	1: Power-on 2: Module Watchdog 3: Software Reset Command	R	-
40256	0100	1	1	Read the boot count of the module The factory default value is 0 when the settings are set to the factory default values.	1 to 32767	R	-
40257	0101	1	1	Set the Host WDT timeout (unit: second)	0: Disable the Host WDT 5 to 65535: Enable the Host WDT	R/W/E	0
40258	0102	1	1	Read the WDT event count The initial value is 0 when the module is reset, and is increased when the WDT even happens.	0 to 32767	R	-
40260	0104	1	1	Read the module name	0x7067	R	-
40271	010F	1	1	Set the module identification (Modbus NetID)	1 to 255	R/W/E	1

ET-7083/PET-7083

I/O Specifications

Counter Input	
Channels	3-axis
Counting Mode	1. Quadrant Mode 2. CW/CCW Mode 3. Pulse/Direction Mode
Maximum Count	4,294,967,285 (32-bit)
Maximum Counting Rate	1. Quadrant mode: 1 MHz 2. CW/CCW mode: 4 MHz 3. Pulse/Direction mode: 4 MHz
Count Value Retention	Yes, for 10 years
Counter Preset Value	Yes, Programmable
Input Signal Level	1. 5 V _{DC} 2. 12 V _{DC} with 1K ohm external resistor 3. 24 V _{DC} with 2K ohm external resistor
Intra-module Isolation, Field to Logic	2500 Vrms

Pin Assignments

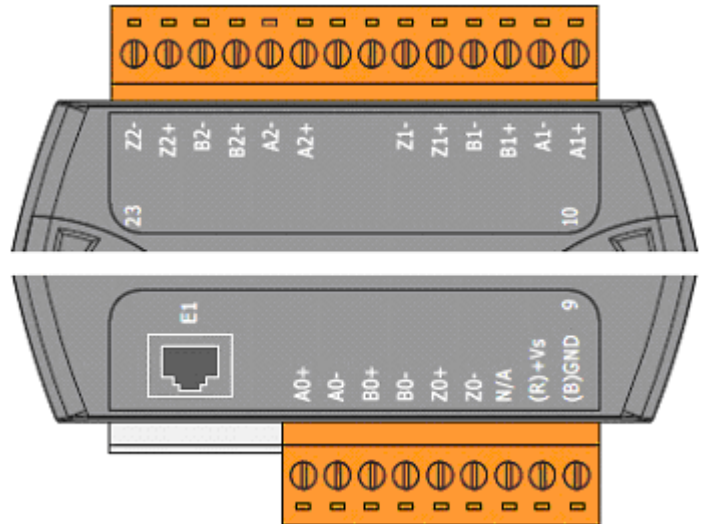

Wire Connections

Input Type	ON State LED ON Readback as 1	OFF State LED OFF Readback as 0
Relay Contact	Relay ON 	Relay OFF
	Voltage > 5 V 	Voltage > 0.8 V
NPN Output	Open Collector ON 	Open Collector OFF
	Open Collector ON 	Open Collector OFF

Modbus Register Table

Coils (0xxxx)

Register		Points	Description	Data Format	Attribute	Factory Set Value
DEC	HEX					
00034 : 00041	0022 : 0029	3	Clear the counter value	1: Clear	W	-
00098 : 00100	0062 : 0064	3	XOR control bit	0: Active high input 1: Active low input	R/W/E	0
00126	007E	1	Reset I/O settings to factory defaults	1: Active	W	-
00133	0085	1	Reboot ET-7000/PET-7000	1: Active	W	-
00345 : 00347	0159 : 015B	3	Back-up the counter values	0: Disable 1: Enable	R/W/E	0

Discrete Inputs (1xxxx)

Register		Points	Description	Data Format	Attribute
DEC	HEX				
10096 : 10098	0060 : 0061	3	Z index channel status	0: Index channel is Low 1: Index channel is High	R

Input Register (3xxxx)

Register		Points	No. Per Point	Description	Data Format	Attribute
DEC	HEX					
30016 : 30021	0010 : 0015	3	2	Encoder counter value	0 to 4294967295	R
30140	008C	1	1	Number of encoder counter channels	3	R
30150	0096	1	1	OS image version	0x123 means version 1.2.3	R
30151	0097	1	1	Firmware version	0x123 means version 1.2.3	R
30153	0099	1	1	I/O version	0x123 means version 1.2.3	R

Holding Register (4xxxx)

Register		Points	No. Per Point	Description	Data Format	Attribute	Factory Value
DEC	HEX						
40032 : 40034	0020 : 0022	3	1	Encoder counting mode	1: CW/CCW Counting Mode 2: Pulse/Direction Counting Mode 3: Quadrant Counting Mode	R/W/E	1
40050 : 40055	0032 : 0037	3	2	Counter preset value	0 to 4294967295	R/W/E	0
40255	00FF	1	1	Module reset status	1: Power-on 2: Module Watchdog 3: Software Reset Command	R	-
40256	0100	1	1	Reset event counter	1 to 32767	R	-
40257	0101	1	1	Host WDT timeout	0 to 65535	R/W/E	0
40258	0102	1	1	WDT event counter	0 to 32767	R	-
40260	0104	1	1	Module name	0x7083	R	-
40271	010F	1	1	Identification of ET-7000/PET-700 (Modbus NetID)	1 to 255	R/W/E	1

Appendix

A. Analog Input Type and Data Format Table

Type Code	Input Range	Data Format	+F.S	-F.S
00	-15 ~ +15 mV	Engineering Unit	+15000	-15000
		2's comp HEX	7FFF	8000
01	-50 ~ +50 mV	Engineering Unit	+5000	-5000
		2's comp HEX	7FFF	8000
02	-100 ~ +100 mV	Engineering Unit	+10000	-10000
		2's comp HEX	7FFF	8000
03	-500 ~ +500 mV	Engineering Unit	+5000	-5000
		2's comp HEX	7FFF	8000
04	-1 ~ +1 V	Engineering Unit	+10000	-10000
		2's comp HEX	7FFF	8000
05	-2.5 ~ +2.5 V	Engineering Unit	+25000	-25000
		2's comp HEX	7FFF	8000
06	-20 ~ +20 mA	Engineering Unit	+20000	-20000
		2's comp HEX	7FFF	8000
07	+4 ~ +20 mA	Engineering Unit	+20000	+4000
		2's comp HEX	FFFF	0000
08	-10 ~ +10 V	Engineering Unit	+10000	-10000
		2's comp HEX	7FFF	8000
09	-5 ~ +5 V	Engineering Unit	+5000	-5000
		2's comp HEX	7FFF	8000
0A	-1 ~ +1 V	Engineering Unit	+10000	-10000
		2's comp HEX	7FFF	8000
0B	-500 ~ +500 mV	Engineering Unit	+5000	-5000
		2's comp HEX	7FFF	8000
0C	-150 ~ +150 mV	Engineering Unit	+15000	-15000
		2's comp HEX	7FFF	8000
0D	-20 ~ +20 mA	Engineering Unit	+20000	-20000
		2's comp HEX	7FFF	8000
1A	0 ~ +20 mA	Engineering Unit	+20000	0
		2's comp HEX	FFFF	0000
0E	Type J Thermocouple -210 ~ 760°C	Engineering Unit	+7600	-2100
		2's comp HEX	7FFF	DCA2
0F	Type K Thermocouple -270 ~ 1372°C	Engineering Unit	+13720	-2700
		2's comp HEX	7FFF	E6D0

ET-7000/PET-7000 Register Table, version 1.0.3

10	Type T Thermocouple -270 ~ 400°C	Engineering Unit	+4000	-2700
		2's comp HEX	7FFF	A99A
11	Type E Thermocouple -270 ~ 1000°C	Engineering Unit	10000	-2700
		2's comp HEX	7FFF	DD71
12	Type R Thermocouple 0 ~ 1768°C	Engineering Unit	+17680	0
		2's comp HEX	7FFF	0000
13	Type S Thermocouple 0 ~ 1768°C	Engineering Unit	+17680	0
		2's comp HEX	7FFF	0000
14	Type B Thermocouple 0 ~ 1820°C	Engineering Unit	+18200	0
		2's comp HEX	7FFF	0000
15	Type N Thermocouple -270 ~ 1300°C	Engineering Unit	+13000	-2700
		2's comp HEX	7FFF	E56B
16	Type C Thermocouple 0 ~ 2320°C	Engineering Unit	+23200	0
		2's comp HEX	7FFF	0000
17	Type L Thermocouple -200 ~ 800°C	Engineering Unit	+8000	-2000
		2's comp HEX	7FFF	E000
18	Type M Thermocouple -200 ~ 100°C	Engineering Unit	+10000	-20000
		2's comp HEX	4000	8000
19	Type L DIN43710 Thermocouple -200 ~ 900°C	Engineering Unit	9000	-2000
		2's comp HEX	FFFF	E38E
20	Platinum 100, $\alpha=0.00385$ -100 ~ 100°C	Engineering Unit	+10000	-10000
		2's comp HEX	7FFF	8000
21	Platinum 100, $\alpha=0.00385$ 0 ~ 100°C	Engineering Unit	+10000	0
		2's comp HEX	7FFF	0000
22	Platinum 100, $\alpha=0.00385$ 0 ~ 200°C	Engineering Unit	+20000	0
		2's comp HEX	7FFF	0000
23	Platinum 100, $\alpha=0.00385$ 0 ~ 600°C	Engineering Unit	+6000	0
		2's comp HEX	7FFF	0000
24	Platinum 100, $\alpha=0.003916$ -100 ~ 100°C	Engineering Unit	+10000	-10000
		2's comp HEX	7FFF	8000
25	Platinum 100, $\alpha=0.003916$ 0 ~ 100°C	Engineering Unit	+10000	0
		2's comp HEX	7FFF	0000
26	Platinum 100, $\alpha=0.003916$ 0 ~ 200°C	Engineering Unit	+20000	0
		2's comp HEX	7FFF	0000
27	Platinum 100, $\alpha=0.003916$ 0 ~ 600°C	Engineering Unit	+6000	0
		2's comp HEX	7FFF	0000
28	Nickel 120, -80 ~ 100°C	Engineering Unit	+10000	-8000
		2's comp HEX	7FFF	999A

ET-7000/PET-7000 Register Table, version 1.0.3

29	Nickel 120 0 ~ 100°C	Engineering Unit	+10000	0
		2's comp HEX	7FFF	0000
2A	Platinum 1000, $\alpha=0.00385$ -200 ~ 600°C	Engineering Unit	+6000	-2000
		2's comp HEX	7FFF	D556
2B	Cu 100, $\alpha=0.00421$ -20 ~ 150°C	Engineering Unit	+15000	-2000
		2's comp HEX	7FFF	EEEE
2C	Cu 100, $\alpha=0.00427$ 0 ~ 200°C	Engineering Unit	+20000	0
		2's comp HEX	7FFF	0000
2D	Cu 1000, $\alpha=0.00421$ -20 ~ 150°C	Engineering Unit	+15000	-2000
		2's comp HEX	7FFF	EEEE
2E	Platinum 1000, $\alpha=0.00385$ -200 ~ 200°C	Engineering Unit	+20000	-20000
		2's comp HEX	7FFF	8000
2F	Platinum 1000, $\alpha=0.003916$ -200 ~ 200°C	Engineering Unit	+20000	-20000
		2's comp HEX	7FFF	8000
80	Platinum 100, $\alpha=0.00385$ -200 ~ 600°C	Engineering Unit	+6000	-2000
		2's comp HEX	7FFF	D556
81	Platinum 100, $\alpha=0.003916$ -200 ~ 600°C	Engineering Unit	+6000	-2000
		2's comp HEX	7FFF	D556
82	Cu 50 -50 ~ 150°C	Engineering Unit	+15000	-5000
		2's comp HEX	7FFF	D556
83	Nickel 100 -60 ~ 180°C	Engineering Unit	+18000	-6000
		2's comp HEX	7FFF	D556

B. Analog Output Type and Data Format Table

Type Code	Input Range	Data Format	+F.S	-F.S
30	0 ~ +20 mV	Engineering Unit	+20000	0
		2's comp HEX	FFFF	0000
31	4 ~ +20 mV	Engineering Unit	+20000	4000
		2's comp HEX	FFFF	0000
32	0 ~ +10 V	Engineering Unit	+10000	0
		2's comp HEX	7FFF	0000
33	-10 ~ +10 V	Engineering Unit	+10000	-10000
		2's comp HEX	7FFF	8000
34	0 ~ +5 V	Engineering Unit	+5000	0
		2's comp HEX	7FFF	0000
35	-5 ~ +5 V	Engineering Unit	+5000	-5000
		2's comp HEX	7FFF	8000

Revision History

The table below shows the revision history.

Revision	Date	Description
1.0.1	December 2011	Initial issue
1.0.2	February 2013	<ol style="list-style-type: none">1. Added more information and the tip about the jumper configuration in product page of the analog input and analog output I/O module.2. Added the revision history in “Revision History” section
1.0.3	May 2013	Added information about the new product, ET-7083/PET-7083