

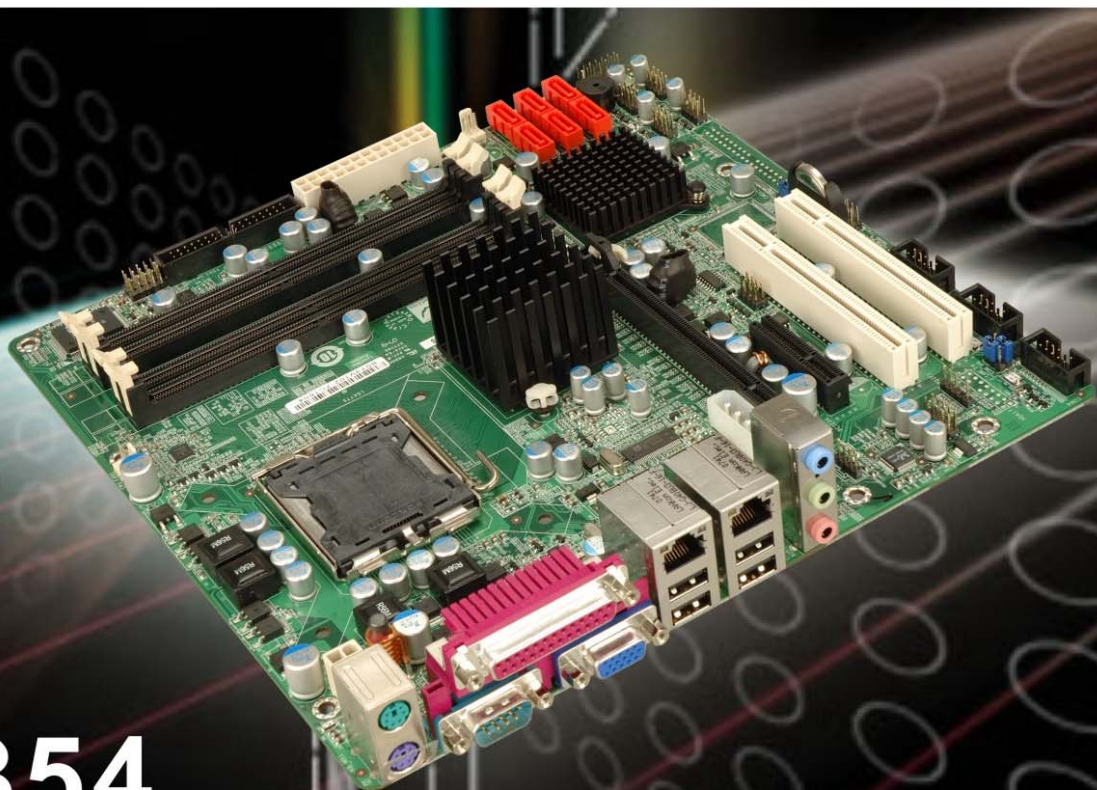

IEI Technology Corp .



**MODEL:
IMB-Q354**

**Intel® Q35 Northbridge uATX Motherboard Supports
Intel® LGA 775 Core™2 Quad/Core™2 Duo/Celeron® CPU
8 GB DD2, Six SATA II, Twelve USB 2.0, One PCIe x16,
One PCIe x4, Two PCI and Dual PCIe GbE**

User Manual

Rev. 1.00 January 2008



Revision

Date	Version	Changes
2008-01	1.00	Initial release

Manual Conventions

 **WARNING!**

Warnings appear where overlooked details may cause damage to the equipment or result in personal injury. Warnings should be taken seriously. Warnings are easy to recognize. The word “warning” is written as “**WARNING**,” both capitalized and bold and is followed by text. The text is the warning message. A warning message is shown below:

 **WARNING:**

This is an example of a warning message. Failure to adhere to warning messages may result in permanent damage to the IMB-Q354 or personal injury to the user. Please take warning messages seriously.

 **CAUTION!**

Cautionary messages should also be heeded to help reduce the chance of losing data or damaging the IMB-Q354. Cautions are easy to recognize. The word “caution” is written as “**CAUTION**,” both capitalized and bold and is followed. The italicized text is the cautionary message. A caution message is shown below:

**CAUTION:**

This is an example of a caution message. Failure to adhere to cautions messages may result in permanent damage to the IMB-Q354. Please take caution messages seriously.

**NOTE:**

These messages inform the reader of essential but non-critical information. These messages should be read carefully as any directions or instructions contained therein can help avoid making mistakes. Notes are easy to recognize. The word “note” is written as “**NOTE**,” both capitalized and bold and is followed by text. The text is the cautionary message. A note message is shown below:

**NOTE:**

This is an example of a note message. Notes should always be read. Notes contain critical information about the IMB-Q354. Please take note messages seriously.

Copyright

COPYRIGHT NOTICE

The information in this document is subject to change without prior notice in order to improve reliability, design and function and does not represent a commitment on the part of the manufacturer.

In no event will the manufacturer be liable for direct, indirect, special, incidental, or consequential damages arising out of the use or inability to use the product or documentation, even if advised of the possibility of such damages.

This document contains proprietary information protected by copyright. All rights are reserved. No part of this manual may be reproduced by any mechanical, electronic, or other means in any form without prior written permission of the manufacturer.

TRADEMARKS

All registered trademarks and product names mentioned herein are used for identification purposes only and may be trademarks and/or registered trademarks of their respective owners.

Packing List

**NOTE:**

If any of the components listed in the checklist below are missing, please do not proceed with the installation. Contact the IEI reseller or vendor you purchased the IMB-Q354 from or contact an IEI sales representative directly. To contact an IEI sales representative, please send an email to sales@iei.com.tw.

The items listed below should all be included in the IMB-Q354 package.

- 1 x IMB-Q354 single board computer
- 3 x SATA power cables
- 6 x SATA cables
- 1 x Dual RS-232 cable
- 1 x USB cable
- 1 x Mini jumper pack
- 1 x Utility CD
- 1 x IO shielding
- 1 x QIG (quick installation guide)

Images of the above items are shown in **Chapter 3**.

Table of Contents

1	INTRODUCTION.....	1
1.1	OVERVIEW	2
1.1.1	<i>IMB-Q354 Features</i>	3
1.2	IMB-Q354 OVERVIEW.....	3
1.2.1	<i>IMB-Q354 Overview Photo</i>	3
1.2.2	<i>IMB-Q354 Peripheral Connectors and Jumpers</i>	4
1.2.3	<i>Technical Specifications</i>	6
2	DETAILED SPECIFICATIONS	9
2.1	DIMENSIONS	10
2.1.1	<i>Board Dimensions</i>	10
2.1.2	<i>External Interface Panel Dimensions</i>	11
2.2	DATA FLOW	12
2.3	COMPATIBLE PROCESSORS	13
2.3.1	<i>Supported Processors Overview</i>	13
2.3.2	<i>Supported Intel® Core™2 Quad (Yorkfield) Processors</i>	13
2.3.3	<i>Supported Intel® Core™2 Duo (Wolfdale) Processors</i>	14
2.3.4	<i>Supported Intel® Core™2 Duo (Conroe) Processors</i>	14
2.3.5	<i>Supported Intel® Celeron® (Conroe) Processors</i>	15
2.4	INTEL® Q35 NORTHBRIDGE CHIPSET	15
2.4.1	<i>Intel® Q35 Northbridge Chipset</i>	15
2.4.2	<i>Intel® Q35 Front Side Bus (FSB) Support</i>	15
2.4.3	<i>Intel® Q35 Memory Controller</i>	16
2.4.4	<i>Intel® Q35 PCIe x16 Interface</i>	17
2.4.5	<i>Intel® Q35 Graphics and Display Features</i>	18
2.4.6	<i>Intel® Q35 Analog Display Capability</i>	18
2.4.7	<i>Intel® Q35 Direct Media Interface (DMI)</i>	19
2.5	INTEL® ICH9DO SOUTHBRIDGE CHIPSET.....	20
2.5.1	<i>Intel® ICH9DO Overview</i>	20
2.5.2	<i>Intel® ICH9DO Features</i>	20
2.5.3	<i>Intel® ICH9DO High Definition Audio Implementation</i>	21

2.5.4 Intel® ICH9DO Ethernet Controller.....	21
2.5.4.1 Intel® 82566DM Gigabit LAN Connect Device.....	22
2.5.5 Intel® ICH9DO Low Pin Count (LPC) Interface.....	23
2.5.6 Intel® ICH9DO PCI Interface.....	24
2.5.7 Intel® ICH9DO PCIe x4 Bus.....	24
2.5.8 Intel® ICH9DO Real Time Clock.....	24
2.5.9 Intel® ICH9DO SATA Controller.....	25
2.5.10 Intel® ICH9DO Serial Peripheral Interface (SPI) BIOS.....	26
2.5.11 Intel® ICH9DO USB Controller.....	26
2.5.11.1 Intel® ICH9DO USB Controller Overview.....	26
2.5.11.2 IMB-Q354 USB Implementation.....	26
2.6 IMB-Q354 PCIe BUS COMPONENTS.....	27
2.6.1 PCIe Bus Overview.....	27
2.6.2 PCIe x16 Slot.....	27
2.6.3 PCIe x4 Slot.....	28
2.6.4 Intel® 82573L PCIe GbE Controller.....	28
2.7 PCI BUS COMPONENTS.....	30
2.7.1 PCI Bus Overview.....	30
2.7.2 PCI Slots.....	30
2.8 LPC BUS COMPONENTS.....	31
2.8.1 LPC Bus Overview.....	31
2.8.2 TPM Module.....	31
2.8.3 Super I/O chipset.....	32
2.8.3.1 Super I/O LPC Interface.....	34
2.8.3.2 Super I/O 16C550 UARTs.....	34
2.8.3.3 Super I/O Enhanced Hardware Monitor.....	34
2.8.3.4 Super I/O Floppy Disk Drive (FDD) Controller.....	34
2.8.3.5 Super I/O Fan Speed Controller.....	35
2.8.3.6 Super I/O Keyboard/Mouse Controller.....	35
2.8.3.7 Super I/O GPIO Ports.....	35
2.8.3.8 Super I/O Infrared.....	35
2.8.3.9 Super I/O Parallel Port.....	35
2.8.3.10 Super I/O Watchdog Timer.....	36
2.8.4 Fintek F81216DG LPC Serial Port Chipset.....	36
2.9 ETHERNET LAN CONTROLLERS.....	36

IMB-Q354 uATX Motherboard

2.10 ENVIRONMENTAL AND POWER SPECIFICATIONS	38
2.10.1 System Monitoring	38
2.10.2 Operating Temperature and Temperature Control.....	38
2.10.3 Power Consumption.....	39
3 UNPACKING	41
3.1 ANTI-STATIC PRECAUTIONS.....	42
3.2 UNPACKING.....	42
3.2.1 Unpacking Precautions.....	42
3.3 UNPACKING CHECKLIST.....	43
3.3.1 Package Contents.....	43
3.4 OPTIONAL ITEMS.....	44
4 CONNECTOR PINOUTS.....	47
4.1 PERIPHERAL INTERFACE CONNECTORS	48
4.1.1 IMB-Q354 Layout	48
4.1.2 Peripheral Interface Connectors	49
4.1.3 External Interface Panel Connectors.....	50
4.2 INTERNAL PERIPHERAL CONNECTORS	51
4.2.1 ATX Power Connector	51
4.2.2 Audio CD In Connector	53
4.2.3 CPU Power Connector	54
4.2.4 Digital Input/Output (DIO) Connector.....	54
4.2.5 Fan Connector, CPU (12V, 4-pin).....	56
4.2.6 Fan Connector, System (+12V, 3-pin).....	57
4.2.7 Floppy Disk Connector (34-pin).....	58
4.2.8 Front Audio Connector	59
4.2.9 Front Panel Connector (14-pin)	60
4.2.10 Infrared Interface Connector	61
4.2.11 PCIe Power Connector	62
4.2.12 SATA Drive Connectors	63
4.2.13 Serial Port Connector (COM2, COM 3 and COM4).....	65
4.2.14 SPDIF Connector.....	66
4.2.15 Trusted Platform Module (TPM) Connector.....	67
4.2.16 USB Connectors (Internal)	68

4.3 EXTERNAL PERIPHERAL INTERFACE CONNECTOR PANEL	69
4.3.1 Audio Connectors.....	69
4.3.2 Keyboard/Mouse Connector	70
4.3.3 LAN and Dual USB Combo Connectors.....	71
4.3.4 Parallel Port, Serial Port and VGA Combo Connector.....	73
5 INSTALLATION	77
5.1 ANTI-STATIC PRECAUTIONS.....	78
5.2 INSTALLATION CONSIDERATIONS	79
5.2.1 Installation Notices	79
5.2.2 Installation Checklist	80
5.3 UNPACKING.....	81
5.3.1 Unpacking Precautions.....	81
5.4 CPU, CPU COOLING KIT AND DIMM INSTALLATION	81
5.4.1 Socket LGA775 CPU Installation	82
5.4.2 Socket LGA775 CF-520 Cooling Kit Installation.....	85
5.4.3 DIMM Installation	87
5.4.3.1 DIMM Purchasing Guidelines	88
5.4.3.2 DIMM Installation Order	88
5.4.3.3 DIMM Installation Guidelines	89
5.5 JUMPER SETTINGS	90
5.5.1 Clear CMOS Jumper.....	91
5.5.2 COM Port Pin 9 Setting Jumpers	92
5.5.3 COM Port Pin 9 Voltage Setting Jumpers	94
5.6 CHASSIS INSTALLATION	95
5.6.1 Airflow.....	95
5.6.2 Motherboard Installation.....	96
5.7 INTERNAL PERIPHERAL DEVICE CONNECTIONS.....	96
5.7.1 Peripheral Device Cables	96
5.7.2 Dual RS-232 Cable Connection.....	96
5.7.3 SATA Drive Connection	97
5.7.4 USB Cable (Dual Port).....	99
5.7.5 PCIe x16 Expansion Card Installation	100
5.8 EXTERNAL PERIPHERAL INTERFACE CONNECTION	101
5.8.1 Audio Connection.....	101

IMB-Q354 uATX Motherboard

5.8.2 LAN Connection (Single Connector)	102
5.8.3 Parallel Device Connection	103
5.8.4 PS/2 Keyboard and Mouse Connection	104
5.8.5 Serial Device Connection	105
5.8.6 USB Device Connection	106
5.8.7 VGA Monitor Connection	107
6 AMI BIOS	109
6.1 INTRODUCTION	110
6.1.1 Starting Setup	110
6.1.2 Using Setup	110
6.1.3 Getting Help	111
6.1.4 Unable to Reboot After Configuration Changes	111
6.1.5 BIOS Menu Bar	111
6.2 MAIN	112
6.3 ADVANCED	113
6.3.1 CPU Configuration	114
6.3.2 IDE Configuration	115
6.3.2.1 IDE Master, IDE Slave	117
6.3.3 Floppy Configuration	123
6.3.4 Super IO Configuration	124
6.3.5 Hardware Health Configuration	128
6.3.6 ACPI Configuration	129
6.3.7 AHCI Configuration	130
6.3.7.1 AHCI Port n	131
6.3.8 Intel AMT Configuration	133
6.3.8.1 ME Subsystem Configuration	133
6.3.9 Remote Access Configuration	136
6.3.10 Trusted Computing	137
6.3.11 USB Configuration	138
6.3.11.1 USB Mass Storage Device Configuration	140
6.4 PCI/PNP	143
6.5 BOOT	145
6.5.1 Boot Settings Configuration	146
6.5.2 Boot Device Priority	148

6.5.3	Hard Disk Drives	149
6.6	SECURITY.....	150
6.7	CHIPSET	151
6.7.1	NorthBridge Configuration.....	152
6.7.2	Southbridge Configuration	154
6.8	EXIT.....	156
7	SOFTWARE DRIVERS	159
7.1	AVAILABLE SOFTWARE DRIVERS	160
7.2	DRIVER CD AUTO-RUN.....	160
7.3	INTEL® CHIPSET DRIVER.....	162
7.4	INTEL® GRAPHICS MEDIA ACCELERATOR DRIVER	166
7.5	INTEL® 82566DM GIGABIT LAN CONNECT DEVICE DRIVER	171
7.6	INTEL® 82573 PCI EXPRESS GIGABIT ETHERNET CONTROLLER DRIVER	178
7.7	REALTEK HD AUDIO DRIVER (ALC883) INSTALLATION	187
7.7.1	BIOS Setup.....	187
7.7.2	Driver Installation	187
7.8	INTEL® MATRIX STORAGE MANAGER DRIVER INSTALLATION	193
7.9	INTEL® ACTIVE MANAGEMENT TECHNOLOGY DRIVER INSTALLATION	199
8	INTEL® AMT CONFIGURATION.....	205
8.1	INTEL® AMT SETUP PROCEDURE.....	206
8.2	INTEL® MANAGEMENT ENGINE BIOS EXTENSION.....	207
8.3	USING THE INTEL® AMT WEB INTERFACE.....	212
A	BIOS OPTIONS.....	215
B	TERMINOLOGY	219
C	DIO INTERFACE.....	225
C.1	DIO INTERFACE INTRODUCTION.....	226
C.2	DIO CONNECTOR PINOUTS.....	226
C.3	ASSEMBLY LANGUAGE SAMPLES.....	227
C.3.1	Enable the DIO Input Function.....	227
C.3.2	Enable the DIO Output Function.....	227
D	WATCHDOG TIMER.....	229

IMB-Q354 uATX Motherboard

E	ADDRESS MAPPING	233
E.1	ADDRESS MAP	234
E.2	1ST MB MEMORY ADDRESS MAP	234
E.3	IRQ MAPPING TABLE.....	235
E.4	DMA CHANNEL ASSIGNMENTS.....	235
F	COMPATIBILITY	237
F.1	COMPATIBLE OPERATING SYSTEMS	238
F.2	COMPATIBLE PROCESSORS	238
F.3	COMPATIBLE MEMORY MODULES	238
G	INTEL[®] MATRIX STORAGE MANAGER	241
G.1	INTRODUCTION	242
	<i>G.1.1 Precautions</i>	<i>242</i>
G.2	FEATURES AND BENEFITS	243
G.3	ACCESSING THE INTEL [®] MATRIX STORAGE MANAGER	243
G.4	RAID CONFIGURATION	244
	<i>G.4.1 Creating a RAID Volume</i>	<i>244</i>
	<i>G.4.2 Deleting a RAID Volume.....</i>	<i>249</i>
	<i>G.4.3 Resetting a Disk to Non-RAID.....</i>	<i>251</i>
	<i>G.4.4 Exiting the Matrix Storage Manager.....</i>	<i>253</i>
H	HAZARDOUS MATERIALS DISCLOSURE	255
H.1	HAZARDOUS MATERIAL DISCLOSURE TABLE FOR IPB PRODUCTS CERTIFIED AS ROHS COMPLIANT UNDER 2002/95/EC WITHOUT MERCURY.....	256
I	INDEX	259

List of Figures

Figure 1-1: IMB-Q354 uATX Motherboard	2
Figure 1-2: IMB-Q354 Overview [Front View].....	4
Figure 2-1: IMB-Q354 Dimensions (mm)	10
Figure 2-2: External Interface Panel Dimensions (mm).....	11
Figure 2-3: Data Flow Block Diagram.....	12
Figure 2-4: Front Side Bus (FSB).....	16
Figure 2-5: DDR2 DIMM Sockets	16
Figure 2-6: VGA Connector	18
Figure 2-7: DMI Chip-to-Chip Connection.....	19
Figure 2-8: Audio Connectors.....	21
Figure 2-9: Intel® 82566DM Gigabit LAN Connect Device	23
Figure 2-10: SATA Drive Connectors	25
Figure 2-11: Onboard USB Implementation.....	27
Figure 2-12: PCIe x16 Slot	28
Figure 2-13: PCIe x4 Slot	28
Figure 2-14: Intel® 82573L PCIe GbE Controller	29
Figure 2-15: PCI Slots	31
Figure 2-16: TPM Connector.....	32
Figure 2-17: ITE IT8712F Super I/O	33
Figure 2-18: LAN Connections	37
Figure 4-1: Connector and Jumper Locations.....	48
Figure 4-2: ATX Power Connector Pinout Locations.....	52
Figure 4-3: Audio CD In Connector Pinouts (4-pin)	53
Figure 4-4: CPU Power Connector Location.....	54
Figure 4-5: DIO Connector Location.....	55
Figure 4-6: +12V Fan Connector Location	56
Figure 4-7: +12V Fan Connector Location	57
Figure 4-8: 34-pin FDD Connector Location.....	58

IMB-Q354 uATX Motherboard

Figure 4-9: Front Audio Connector Location (10-pin)	59
Figure 4-10: Front Panel Connector Pinout Locations (14-pin).....	61
Figure 4-11: Infrared Connector Location.....	62
Figure 4-12: PCIe Power Connector Location	63
Figure 4-13: SATA Drive Connector Locations	64
Figure 4-14: Serial Connector Location	65
Figure 4-15: SPDIF Connector Location	66
Figure 4-16: TPM Connector Location	67
Figure 4-17: USB Connector Locations	68
Figure 4-18: IMB-Q354 External Peripheral Interface Connector	69
Figure 4-19: Audio Connector	70
Figure 4-20: PS/2 Pinouts	70
Figure 4-21: RJ-45 Ethernet Connector.....	72
Figure 4-22 Parallel Port Connector Pinout Locations.....	73
Figure 4-23: COM1 Pinout Locations	74
Figure 4-24: VGA Connector	75
Figure 5-1: Intel® LGA775 Socket.....	82
Figure 5-2: Remove the CPU Socket Protective Shield.....	83
Figure 5-3: Open the CPU Socket Load Plate.....	84
Figure 5-4: Insert the Socket LGA775 CPU.....	85
Figure 5-5: IEI CF-520 Cooling Kit	86
Figure 5-6: Securing the Heat sink to the PCB Board	87
Figure 5-7: DDR2 Channels	88
Figure 5-8: Installing a DIMM.....	90
Figure 5-9: Clear CMOS Jumper	92
Figure 5-10: COM Port Pin 9 Setting Jumper Locations	93
Figure 5-11: COM Port Pin 9 Voltage Setting Jumper Locations	95
Figure 5-12: Dual RS-232 Cable Installation	97
Figure 5-13: SATA Drive Cable Connection.....	98
Figure 5-14: SATA Power Drive Connection.....	98
Figure 5-15: Dual USB Cable Connection	99
Figure 5-16: PCIe x16 Installation	100

Figure 5-17: Audio Connectors	102
Figure 5-18: LAN Connection	103
Figure 5-19: Parallel Device Connector.....	104
Figure 5-20: PS/2 Keyboard/Mouse Connector	105
Figure 5-21: Serial Device Connector.....	106
Figure 5-22: USB Device Connection	107
Figure 5-23: VGA Connector	108
Figure 7-1: Introduction Screen	161
Figure 7-2: Available Drivers	161
Figure 7-3: Intel® Chipset Driver Directory.....	162
Figure 7-4: Intel® Chipset Driver Setup Icon	163
Figure 7-5: Intel® Package Manager.....	164
Figure 7-6: Intel® Setup Welcome Screen	164
Figure 7-7: Intel® Chipset Driver License Agreement.....	165
Figure 7-8: Readme File	165
Figure 7-9: Intel® Chipset Driver Complete Installation Screen.....	166
Figure 7-10: Select the Operating System	167
Figure 7-11: Intel® Driver Directory.....	167
Figure 7-12: Intel® VGA Driver Setup Icon	168
Figure 7-13: GMA Driver Readme File	169
Figure 7-14: GMA Driver File Extraction	169
Figure 7-15: GMA Driver Installation Welcome Screen	170
Figure 7-16: GMA Driver License Agreement.....	170
Figure 7-17: GMA Driver Installing Notice	171
Figure 7-18: GMA Driver Installation Complete.....	171
Figure 7-19: Intel® 82566DM Driver Directory Icon.....	172
Figure 7-20: Intel® 82566DM Operating System	173
Figure 7-21: Select Operating System Type	174
Figure 7-22: Driver Directory	174
Figure 7-23: Intel® 82566DM Device Driver Startup Icon	175
Figure 7-24: Intel® 82566DM Welcome Screen	176
Figure 7-25: Intel® 82566DM Driver License Agreement.....	176

IMB-Q354 uATX Motherboard

Figure 7-26: Intel® 82566DM Driver Setup Options	177
Figure 7-27: Intel® 82566DM Driver Installation Ready Window	177
Figure 7-28: Intel® 82566DM Driver Installation Progress	178
Figure 7-29: Intel® 82573 Driver Directory Icon	179
Figure 7-30: Intel® 82573 Operating System	180
Figure 7-31: Select Operating System Type	181
Figure 7-32: Driver Directory	181
Figure 7-33: Intel® 82573 Driver Startup Icon	182
Figure 7-34: Intel® 82573 License Agreement.....	183
Figure 7-35: Intel® 82573 File Location Select	183
Figure 7-36: Intel® 82573 Installation Files Extraction	184
Figure 7-37: Intel® PRO Network Connections window	184
Figure 7-38: Intel® PRO Network Connections Welcome	185
Figure 7-39: License Agreement.....	185
Figure 7-40: Setup Type.....	186
Figure 7-41: Intel® 82573 Driver Installation Progress.....	186
Figure 7-42: Select the Audio CODEC.....	188
Figure 7-43: Select the OS.....	189
Figure 7-44: Select the OS Version.....	189
Figure 7-45: Locate the Setup Program Icon.....	190
Figure 7-46: The InstallShield Wizard Starts	190
Figure 7-47: Preparing Setup Screen	191
Figure 7-48: InstallShield Wizard Welcome Screen	191
Figure 7-49: Audio Driver Software Configuration.....	192
Figure 7-50: Installation Wizard Updates the System.....	192
Figure 7-51: Restart the Computer	193
Figure 7-52: SATA RAID Driver Installation Program	194
Figure 7-53: SATA RAID Setup Program Icon	195
Figure 7-54: InstallShield Wizard Setup Screen	195
Figure 7-55: Matrix Storage Manager Setup Screen	196
Figure 7-56: Matrix Storage Manager Welcome Screen	196
Figure 7-57: Matrix Storage Manager Warning Screen.....	197

Figure 7-58: Matrix Storage Manager License Agreement.....	197
Figure 7-59: Matrix Storage Manager Readme File.....	198
Figure 7-60: Matrix Storage Manager Setup Complete.....	198
Figure 7-61: IAMT Driver Directory	199
Figure 7-62: IAMT Driver Installation Icon	200
Figure 7-63: IAMT Welcome Screen	200
Figure 7-64: IAMT License Agreement	201
Figure 7-65: IAMT Readme File	201
Figure 7-66: IAMT Setup Operations	202
Figure 7-67: Completed Installation	202
Figure 7-68: IAMT Driver Directory.....	203
Figure 7-69: HECI Driver Installation Icon.....	203
Figure 8-1: Intel® Active Management Technology Status Dialog.....	206
Figure 8-2: Intel® Current ME Password.....	207
Figure 8-3: Change Intel® ME Password	208
Figure 8-4: Verify New Password.....	208
Figure 8-5: Intel® AMT Configuration.....	208
Figure 8-6: Provision Model	209
Figure 8-7: Intel® AMT 3.0 Mode.....	209
Figure 8-8: Enterprise	210
Figure 8-9: Enable Network Interface	210
Figure 8-10: Exit.....	211
Figure 8-11: Intel® AMT Web Address	212
Figure 8-12: Intel® AMT Web Login Dialog.....	213
Figure 8-13: Intel® AMT Web Interface.....	214

List of Tables

Table 1-1: Technical Specifications.....	7
Table 2-1: Supported Intel® Core™2 Duo (Conroe) Processors	15
Table 2-2: Supported Intel® Celeron® Processors.....	15
Table 2-3: Power Consumption.....	39
Table 3-1: Package List Contents	44
Table 3-2: Package List Contents	45
Table 4-1: Peripheral Interface Connectors	50
Table 4-2: Rear Panel Connectors	51
Table 4-3: ATX Power Connector Pinouts	52
Table 4-5: Audio CD In Connector Pinouts.....	53
Table 4-6: CPU Power Connector Pinouts	54
Table 4-7: DIO Connector Pinouts	55
Table 4-8: +12V Fan Connector Pinouts.....	56
Table 4-9: +12V Fan Connector Pinouts.....	57
Table 4-10: 34-pin FDD Connector Pinouts	59
Table 4-4: Front Audio Connector Pinouts	60
Table 4-11: Front Panel Connector Pinouts (14-pin)	61
Table 4-12: Infrared Connector Pinouts	62
Table 4-13: PCIe Power Connector Pinouts.....	63
Table 4-14: SATA Drive Connector Pinouts.....	64
Table 4-15: Serial Connector Pinouts.....	65
Table 4-16: SPDIF Connector Pinouts.....	66
Table 4-17: TPM Connector Pinouts.....	67
Table 4-18: USB Port Connector Pinouts.....	68
Table 4-19: PS/2 Connector Pinouts.....	71
Table 4-20: LAN Pinouts	71
Table 4-21: RJ-45 Ethernet Connector LEDs	72
Table 4-22: USB Port Pinouts.....	72

Table 4-23: Parallel Port Connector Pinouts	74
Table 4-24: RS-232 Serial Port (COM 1) Pinouts	74
Table 4-25: VGA Connector Pinouts.....	75
Table 5-1: Jumpers.....	91
Table 5-2: Clear CMOS Jumper Settings.....	92
Table 5-3: COM Port Pin 9 Setting Jumper Settings.....	93
Table 5-4: COM Port Pin 9 Voltage Setting Jumper Settings.....	94
Table 5-5: IEI Provided Cables	96
Table 6-1: BIOS Navigation Keys	111

BIOS Menus

Menu 1: Main	112
Menu 2: Advanced	114
Menu 3: CPU Configuration	115
Menu 4: IDE Configuration	116
Menu 5: IDE Master and IDE Slave Configuration.....	118
Menu 6: IDE Master and IDE Slave Configuration.....	123
Menu 7: Super IO Configuration	124
Menu 8: Hardware Health Configuration.....	128
Menu 9: ACPI Configuration.....	130
Menu 10: AHCI Configuration.....	131
Menu 11: AHCI Port n Configuration Menu.....	132
Menu 12: Intel AMT Configuration	133
Menu 13: Me Subsystem Configuration	134
Menu 14: Remote Access Configuration [Advanced].....	136
Menu 15: Trusted Computing	138
Menu 16: USB Configuration.....	139
Menu 17: USB Mass Storage Device Configuration.....	141
Menu 18: PCI/PnP Configuration	143
Menu 19: Boot.....	145
Menu 20: Boot Settings Configuration	146
Menu 21: Boot Device Priority Settings	148
Menu 22: Hard Disk Drives	149
Menu 23: Security	150
Menu 24: Chipset.....	151
Menu 25:Northbridge Chipset Configuration	152
Menu 26:Southbridge Chipset Configuration.....	154
Menu 27:Exit.....	156

THIS PAGE IS INTENTIONALLY LEFT BLANK

Chapter

1

Introduction

1.1 Overview

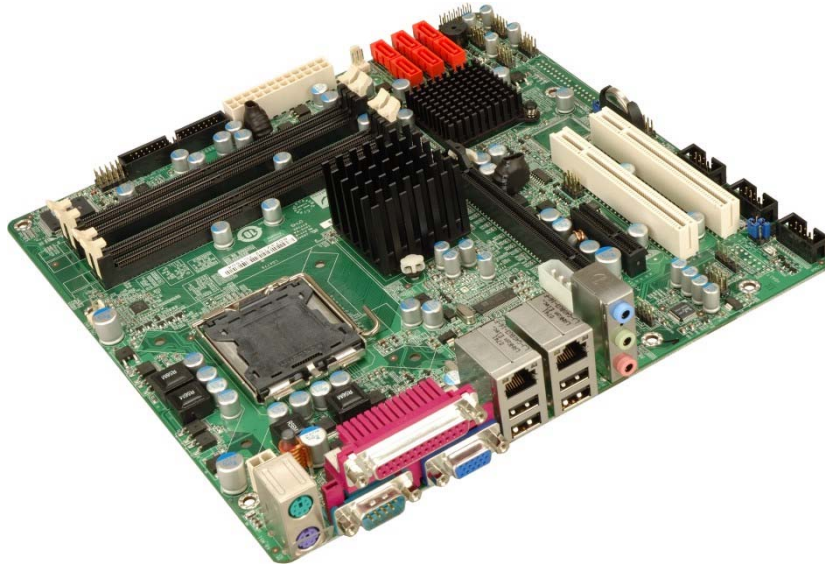

Figure 1-1: IMB-Q354 uATX Motherboard

The IMB-Q354 uATX form factor motherboard (**Figure 1-1**) is an LGA775 Intel® Core™2 Quad, Intel® Core™2 Duo or Intel® Celeron® CPU processor platform. Both 45nm core (Wolfdale, Yorkfield) and 65nm core (Conroe) processors are supported. (For a full list of supported processors please refer to **Section 2.3**)

Up to four 2.0 GB 667 MHz or 800 MHz un-buffered DDR2 SDRAM DIMM are supported by the Intel® Q35 graphics memory controller hub (GMCH). The Intel® Q35 GMCH also has a single PCI Express x16 (PCIe x16) expansion lane for a PCIe x16 graphics card.

The integrated Intel® ICH9DO I/O controller hub (ICH) supports six SATA II drives with data transfer speeds of 3.0 Gbps with SATA RAID configuration support. Twelve USB 2.0 channels, one expansion PCIe x4 channel and two expansion PCI channels provide flexible expansion options. Support for a (optional) trusted platform module (TPM) provides additional system security during system boot-up.

IMB-Q354 uATX Motherboard

1.1.1 IMB-Q354 Features

Some of the IMB-Q354 features are listed below.

- Supports the following Intel® LGA775 processors:
 - Intel® Core™2 Duo (45nm and 65nm)
 - Intel® Core™2 Quad (45nm and 65nm)
 - Intel® Celeron® (65nm)
- Supports four 240-pin 2 GB 667 MHz or 800 MHz DDR2 DIMMs
- Six SATA II drives with transfer rates of 3.0 Gbps supported
- Twelve USB 2.0 devices supported (eight onboard and four on the rear panel)
- Dual GbE Ethernet connectors
- uATX form factor
- RoHS compliant
- Supports ATX power supplies

1.2 IMB-Q354 Overview

1.2.1 IMB-Q354 Overview Photo

The IMB-Q354 has a wide variety of peripheral interface connectors. **Figure 1-2** is a labeled photo of the peripheral interface connectors on the IMB-Q354.

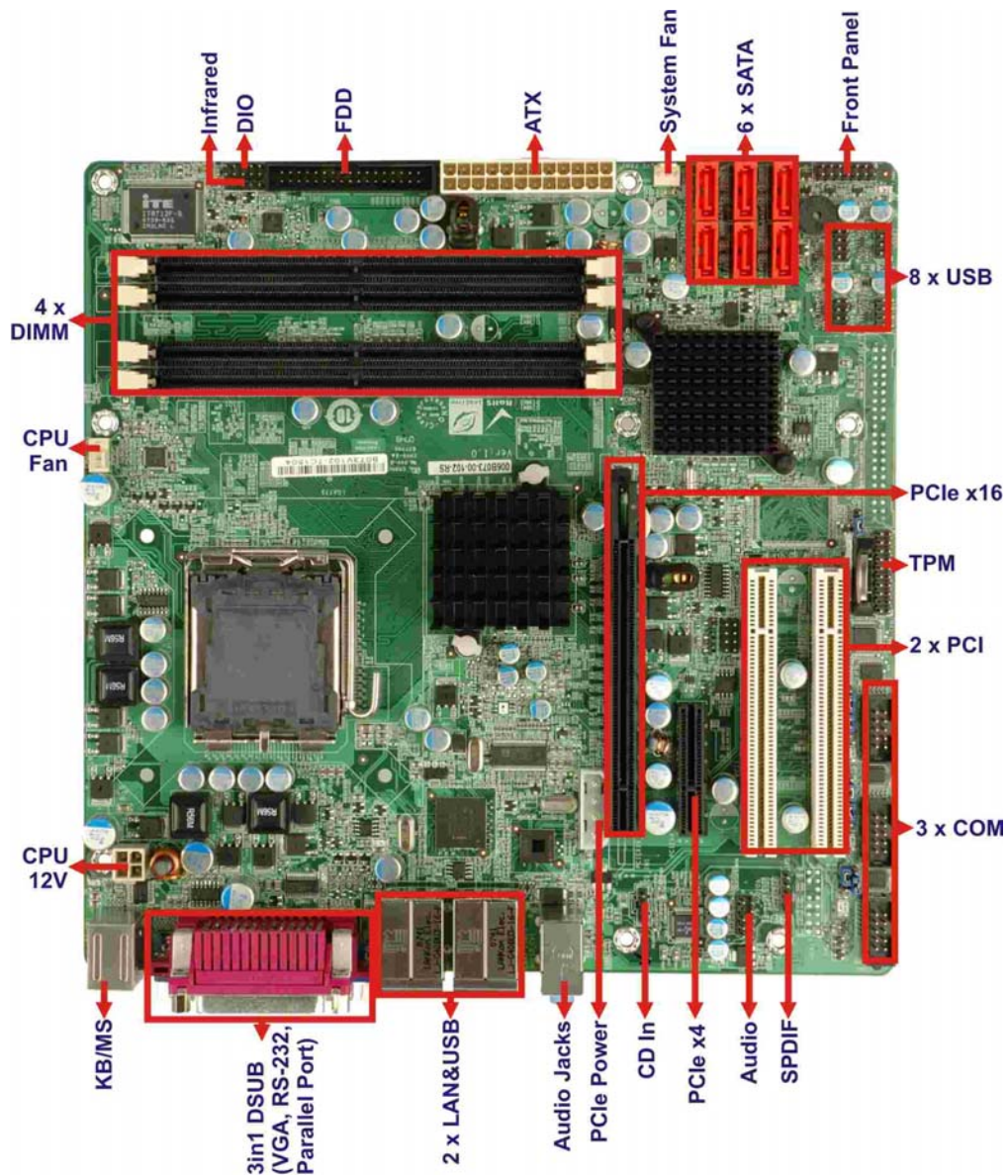

Figure 1-2: IMB-Q354 Overview [Front View]

1.2.2 IMB-Q354 Peripheral Connectors and Jumpers

The IMB-Q354 has the following connectors on-board:

- 1 x ATX power connector
- 1 x Audio connector
- 1 x CD in connector
- 1 x Cooling fan connector, CPU

IMB-Q354 uATX Motherboard

- 1 x Cooling fan connector, System
- 1 x CPU power connector
- 1 x Digital input/output connector
- 4 x DIMM sockets
- 1 x Floppy drive connector
- 1 x Front panel connector
- 1 x Infrared (IrDA) connector
- 2 x PCI slots
- 1 x PCIe x16 slots
- 1 x PCIe x4 slots
- 1 x PCIe power connector
- 6 x Serial ATA drive connectors
- 3 x Serial port connectors
- 1 x SPDIF connector
- 1 x SPI flash connector
- 1 x TPM connector
- 4 x USB connectors (support eight USB devices)

The IMB-Q354 has the following external peripheral interface connectors on the board rear panel.

- 3 x Audio jacks
- 2 x Keyboard/mouse connectors
- 1 x Parallel port
- 2 x RJ-45 Ethernet connectors
- 1 x Serial port
- 4 x USB 2.0 connectors
- 1 x VGA connector

The IMB-Q354 has the following on-board jumpers:

- Clear CMOS
- COM port pin 9 setting
- COM port pin 9 voltage setting

1.2.3 Technical Specifications

IMB-Q354 technical specifications are listed in **Table 1-1**. See **Chapter 2** for details.

Specification	IMB-Q354
Form Factor	uATX
System CPU	LGA775 Intel® Core™2 Quad LGA775 Intel® Core™2 Duo LGA775 Intel® Celeron®
Front Side Bus (FSB)	800 MHz, 1066 MHz or 1333 MHz
System Chipset	Northbridge: Intel® Q35 Express Chipset Southbridge: Intel® ICH9DO
Memory	Four 240-pin DDR2 DIMM sockets support 2.0 GB 667 MHz or 800 MHz DDR2 DIMMs
Super I/O	ITE IT8712F Rev. I
Display	Analog VGA display through external DB-15 connector
BIOS	AMI BIOS label SPI EEPROM 4.0 MB
Audio	RealTek ALC883 codec.
LAN	One Intel® 82566DM (PHY) and Intel® ICH9DO (MAC) One PCIe x1 Intel® 82573L (MAC and PHY)
COM	Four RS-232 serial ports <ul style="list-style-type: none"> ■ Three by onboard pin-headers ■ One by external connector
USB2.0	Twelve USB 2.0 devices supported: <ul style="list-style-type: none"> ■ Eight by onboard pin-headers

IMB-Q354 uATX Motherboard

	<ul style="list-style-type: none"> ■ Four by external connectors
SATA	Six 3.0 Gb/s SATA II drives supported
SATA RAID Levels	RAID 0, RAID 1, RAID 5 and RAID 10
Keyboard/mouse	By external PS/2 connector through the ITE IT8712F super I/O
Digital I/O	One 8-bit digital input/output connector; 4-bit input/4-bit output through the ITE IT8712F super I/O
Watchdog Timer	Software programmable 1-255 sec. through the ITE IT8712F super I/O
Infrared	One IrDA connector through the ITE IT8712F super I/O.
Power Supply	ATX power supply
TPM	Supports TPM v1.2 with 20-pin onboard pin-header
Fan Connector	Three pin system fan pin-header Four pin CPU fan pin-header
Buzzer	Yes
Power Consumption	3.3V@2.41A, 5V@5.71A, +12V@3.69A (3Dmark® 2001) and 5VSB@0.13A (3.0 GHz E6850 Intel® Core™2 Duo CPU with four 2.0 GB, 800 MHz DDR2 DIMM running 3Dmark® 2001)
Temperature	0°C – 60°C (32°F - 140°F)
Humidity (operating)	5%~95% non-condensing
Dimensions (LxW)	244 mm x 244 mm
Weight (GW)	1.1 kg

Table 1-1: Technical Specifications



THIS PAGE IS INTENTIONALLY LEFT BLANK

Chapter

2

Detailed Specifications

IMB-Q354 uATX Motherboard

2.1.2 External Interface Panel Dimensions

External peripheral interface connector panel dimensions are shown in **Figure 2-2**.

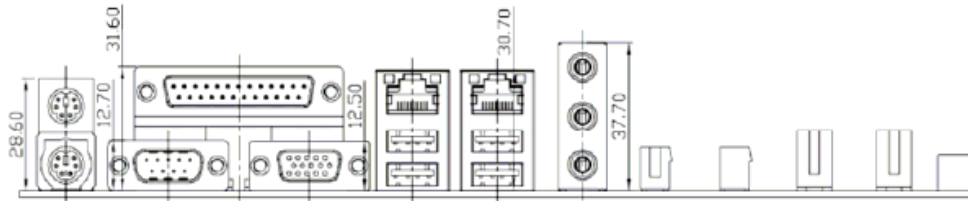

Figure 2-2: External Interface Panel Dimensions (mm)

2.2 Data Flow

Figure 2-3 shows the data flow between the two on-board chipsets and other components installed on the motherboard and described in the following sections of this chapter.

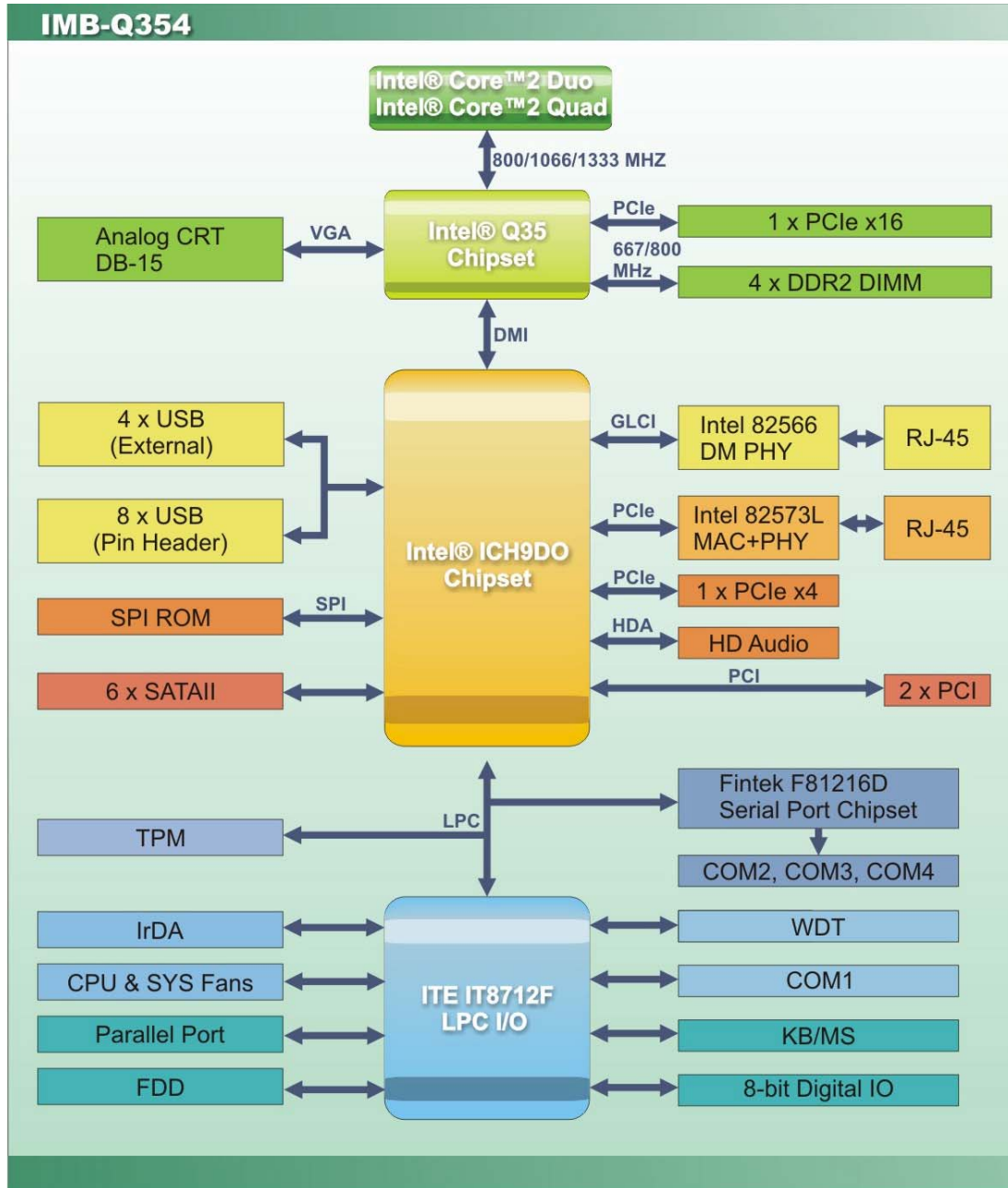

Figure 2-3: Data Flow Block Diagram

2.3 Compatible Processors

2.3.1 Supported Processors Overview

The IMB-Q354 supports the following Intel® LGA775 processors

- Intel® Core™2 Quad (Yorkfield)
- Intel® Core™2 Duo (Wolfdale)
- Intel® Core™2 Duo (Conroe)
- Intel® Celeron® (Conroe)

2.3.2 Supported Intel® Core™2 Quad (Yorkfield) Processors

The Yorkfield core Intel® Core™2 Quad CPU is a 45nm LGA775 processor.

**NOTE:**

As of the date of writing this manual (December, 2007), Intel® has not released Intel® Core™2 Quad (Yorkfield) processor numbers that are supported by the Intel® Northbridge. As soon as processor numbers are released, the manual will be updated.

For further details about supported Intel® Core™2 Quad (Yorkfield) processors, please contact Intel® directly.

2.3.3 Supported Intel® Core™2 Duo (Wolfdale) Processors

The Wolfdale core Intel® Core™2 Duo CPU is a 45nm LGA775 processor.



NOTE:

As of the date of writing this manual (December, 2007), Intel® has not released Wolfdale core Intel® Core™2 Duo processor numbers that are supported by the Intel® Q35 Northbridge. As soon as processor numbers are released, the manual will be updated.

For further details about supported Intel® Core™2 Duo (Wolfdale) processors, please contact Intel® directly.

2.3.4 Supported Intel® Core™2 Duo (Conroe) Processors

Table 2-1 lists the Conroe core Intel® Core™2 Duo processors supported on the IMB-Q354. All the processors in Table 2-1 are 65nm LGA775 processors with the following features:

- Enhanced Halt State (C1E)
- Enhance Intel® Speedstep® Technology
- Execute Disable Bit
- Intel® 64
- Intel® Thermal Monitor 2
- Intel® Virtualization Technology
- Intel® Dual Core Technology

IMB-Q354 uATX Motherboard

Processor #	CPU Speed	FSB Speed	Cache Size
E6850	3.0 GHz	1333 MHz	4 MB

Table 2-1: Supported Intel® Core™2 Duo (Conroe) Processors

2.3.5 Supported Intel® Celeron® (Conroe) Processors

Table 2-1 lists the Conroe core Intel® Celeron® processors supported on the IMB-Q354. All the processors in Table 2-1 are 65nm LGA775 processors with the following features:

- Execute Disable Bit
- Intel® 64

Processor #	CPU Speed	FSB Speed	Cache Size
440	2.0 GHz	800 MHz	512kB

Table 2-2: Supported Intel® Celeron® Processors

2.4 Intel® Q35 Northbridge Chipset

2.4.1 Intel® Q35 Northbridge Chipset

The Intel® Q35 Northbridge chipset is an advanced Graphics and Memory Controller Hub (GMCH) that supports a range of Intel® processors including 45nm Wolfdale dual core and Yorkfield quad core and 65nm Conroe core processors. The Intel® Q35 Northbridge supports 1333 MHz, 1066 MHz, or 800 MHz FSB and up to 8.0 GB of 667 MHz or 800 MHz DDR2 SDRAM. The Intel® Q35 Northbridge is interfaced to an Intel® ICH9DO Southbridge chipset through a Direct Media Interface (DMI) communications link.

2.4.2 Intel® Q35 Front Side Bus (FSB) Support

The Intel® Q35 Northbridge supports processors with the following FSB speeds:

- 800 MHz
- 1066 MHz

- 1333 MHz

The LGA775 socket, Intel® Q35 Northbridge and the FSB are shown in **Figure 2-4**.

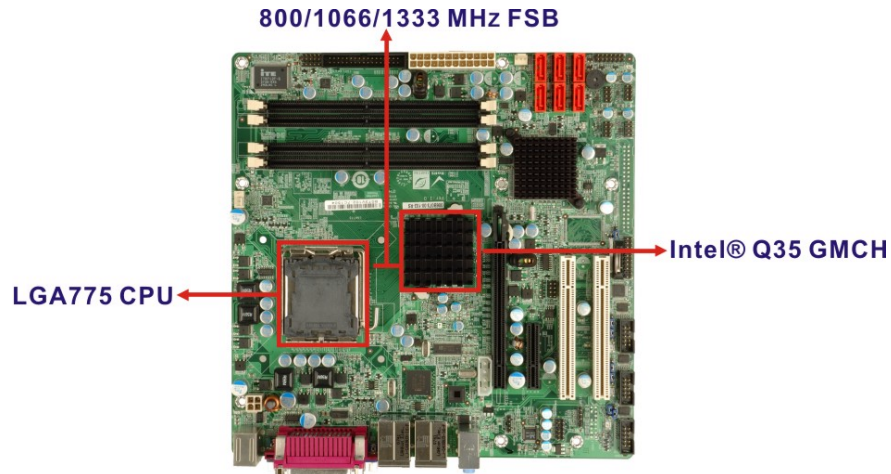

Figure 2-4: Front Side Bus (FSB)

2.4.3 Intel® Q35 Memory Controller

The memory controller on the Intel® Q35 Northbridge can support up to 8.0 GB of DDR2 SDRAM. Four DDR2 SDRAM DIMM sockets on the IMB-Q354 are interfaced to the Intel® Q35 Northbridge memory controller. The DDR2 sockets are shown in **Figure 2-5**.

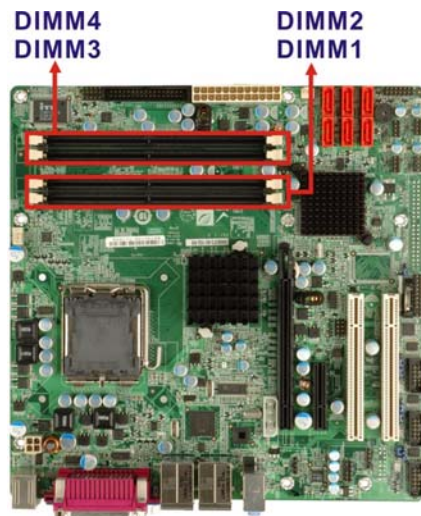

Figure 2-5: DDR2 DIMM Sockets

**CAUTION:**

If more than one DDR2 DIMM is being installed in the system, please purchase two DIMM that have the same capacity and operating frequency.

Each DIMM socket can support DIMMs with the following specifications:

- DDR2 only
- Un-buffered only
- 667 MHz or 800 MHz
- 2.0 GB maximum capacity per DIMM (8.0 GB supported with four DIMM)
- Memory bandwidth:
 - 6.4 GBps in single-channel or dual-channel asymmetric mode
 - 12.8 GBps in dual-channel interleaved mode assuming DDR2 800MHz

2.4.4 Intel® Q35 PCIe x16 Interface

The Intel® Q35 PCIe bus is compliant with the PCI Express 1.1a Specifications has the following PCIe lanes:

- One PCIe x16 graphics interface
- PCIe frequency of 1.25 GHz (2.5 Gbps in each direction)

For further details on the PCIe interfaces, please refer to **Section 2.6.2** on **page 27**.

2.4.5 Intel® Q35 Graphics and Display Features



NOTE:

The Intel® Q35 Graphics and Display Features can be configured in the Northbridge BIOS configuration screen. Please refer to **Section 6.7.1** on **page 152**.

The Intel® Q35 GMCH integrated graphics device (IGD) has 3D, 2D and video capabilities. The Unified Memory Architecture (UMA) uses up to 256 MB of Dynamic Video Memory Technology (DVMT) for graphics memory. External graphics accelerators on the PCIe graphics (PEG) port are supported but cannot work simultaneously with the IGD.

2.4.6 Intel® Q35 Analog Display Capability

A single external female DB-15 (VGA) connector interfaces an analog display to an analog CRT port on the Intel® Q35 GMCH. The VGA connector is shown in **Figure 2-6**.



Figure 2-6: VGA Connector

IMB-Q354 uATX Motherboard

Some of the capabilities of the Intel® Q35 analog CRT port are listed below:

- 400 MHz Integrated 24-bit RAMDAC
- Up to 2048x1536 @ 75 Hz refresh
- Hardware Color Cursor Support
- DDC2B Compliant Interface

2.4.7 Intel® Q35 Direct Media Interface (DMI)

The Direct Media Interface (DMI) is the communication bus between the Intel® Q35 GMCH and the ICH9DO I/O controller hub (ICH). The DMI is a high-speed interface that integrates advanced priority-based servicing and allows for concurrent traffic and true isochronous transfer capabilities. The DMI is shown in **Figure 2-7**.

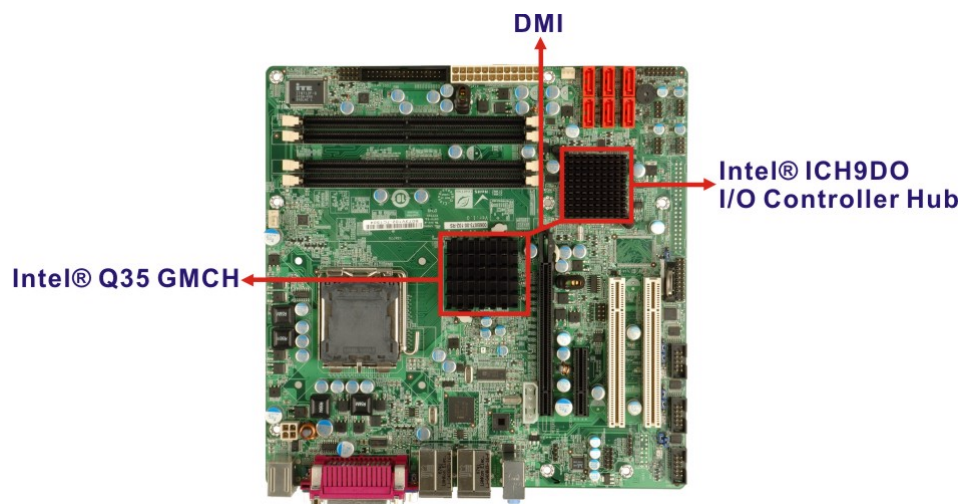

Figure 2-7: DMI Chip-to-Chip Connection

Some of the features of the DMI include:

- 2.0 GBps point-to-point DMI to ICH9DO (1.0 GBps in each direction)
- 100 MHz reference clock (shared with PCI Express* Graphics Attach)
- 32-bit downstream addressing
- APIC and MSI interrupt messaging support
- Message Signaled Interrupt (MSI) messages
- SMI, SCI and SERR error indication

2.5 Intel® ICH9DO Southbridge Chipset

2.5.1 Intel® ICH9DO Overview

Intel® ICH9DO Southbridge is an advanced I/O controller hub (ICH) connected to the Intel® Q35 Northbridge through a DMI connection. The Intel® ICH9DO has six PCIe x1 ports, supports up to twelve USB 2.0 devices, six 3.0 Gbps SATA II drives with Intel® Matrix Storage Technology (ACHI, RAID 0, RAID 1, RAID 5 or RAID 10). A High-Definition audio (HDA) controller can be connected to an HDA codec. The PCI Masters provide PCI expansion capabilities through the two PCI slots on the motherboard.

2.5.2 Intel® ICH9DO Features

The ICH9DO Southbridge chipset on the IMB-Q354 has the features listed below.

- Complies with PCI Express Base Specification, Revision 1.1
- Complies with PCI Local Bus Specification, Revision 2.3 and supports 33MHz PCI operations
- Supports ACPI Power Management Logic
- Contains:
 - Enhanced DMA controller
 - Interrupt controller
 - Timer functions
- Integrated SATA host controller with DMA operations on six ports with data transfer rates up to 3.0 Gbps
- Supports twelve USB 2.0 devices with six UHCI controllers and two EHCI controller
- Complies with System Management Bus (SMBus) Specification, Version 2.0
- Supports Intel® High Definition Audio
- Supports Intel® Matrix storage technology
- Contains Low Pin Count (LPC) interface
- Serial Peripheral Interface (SPI) for Serial and Shared Flash

IMB-Q354 uATX Motherboard

2.5.3 Intel® ICH9DO High Definition Audio Implementation

A RealTek ALC883 High Definition Audio (HDA) codec is interfaced through the Intel® High Definition Audio serial link to the HDA controller integrated on the Intel® ICH9DO. The audio connector is shown in **Figure 2-8**.

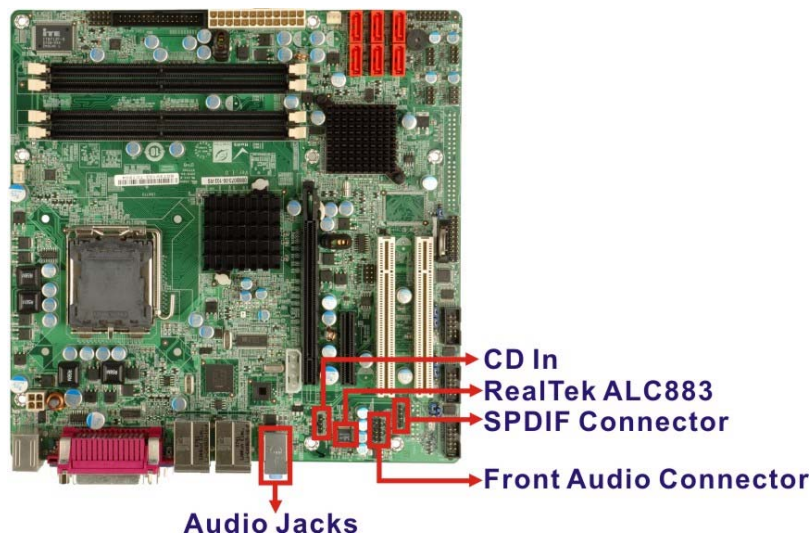

Figure 2-8: Audio Connectors

2.5.4 Intel® ICH9DO Ethernet Controller



NOTE:

Gigabit Ethernet (1000 Mbps) is only supported in S0.

The Intel® ICH9DO Southbridge integrated GbE controller is interfaced to an Intel® 82566DM Gigabit LAN connect device through the Gigabit LAN Connect Interface (GLCI) and LAN Connect Interface (LCI). The GLCI is shared with the PCIe x1 port 6. The Intel® 82566DM connects the Intel® ICH9DO Southbridge integrated GbE controller to an external RJ-45 Ethernet LAN connector to provide GbE access.

**NOTE:**

To enable the Intel® ICH9DO GbE Wake-on LAN function, the Wake-on LAN function must be enabled in the BIOS. Please refer to **Section 6.5.1** (the **Boot Settings Configuration** menu) on **page 146**.

Some of the features of the Intel® ICH9DO GbE controller are listed below.

- Supports multi speeds including 10 Mbps, 100 Mbps and 1000 Mbps
- Can operate in full-duplex mode at all supported speeds
- Can operate at half-duplex at 10 MBps and 100 MBps
- Adheres to the IEEE 802.3x Flow Control Specification.
- 64-bit address master support for system using more than 4 GB of physical memory.
- Configurable receive and transmit data FIFO, programmable in 1 KB increments.
- Intelligent interrupt generation to enhance driver performance.
- Compliance with Advanced Configuration and Power Interface
- Compliance with PCI Power Management standards.
- ACPI register set and power down functionality supporting D0 & D3 states.
- Full wake-up support (ACPI).
- Magic Packet wake-up enable with unique MAC address.
- Fragmented UDP checksum off load for package reassembly.
- Jumbo frames supported.

2.5.4.1 Intel® 82566DM Gigabit LAN Connect Device

One of the external RJ-45 Ethernet LAN connectors is interfaced to an Intel® 82566DM Gigabit LAN connect device. The Intel® 82566DM is a compact, single-port integrated physical layer (PHY) device interfaced directly to the Intel® ICH9DO Ethernet controller through the GLCI and LCI. The Intel® ICH9DO Ethernet controller has its own Media Access Controller (MAC). The Intel® 82566DM Gigabit LAN connect device is shown in **Figure 2-9**.

IMB-Q354 uATX Motherboard

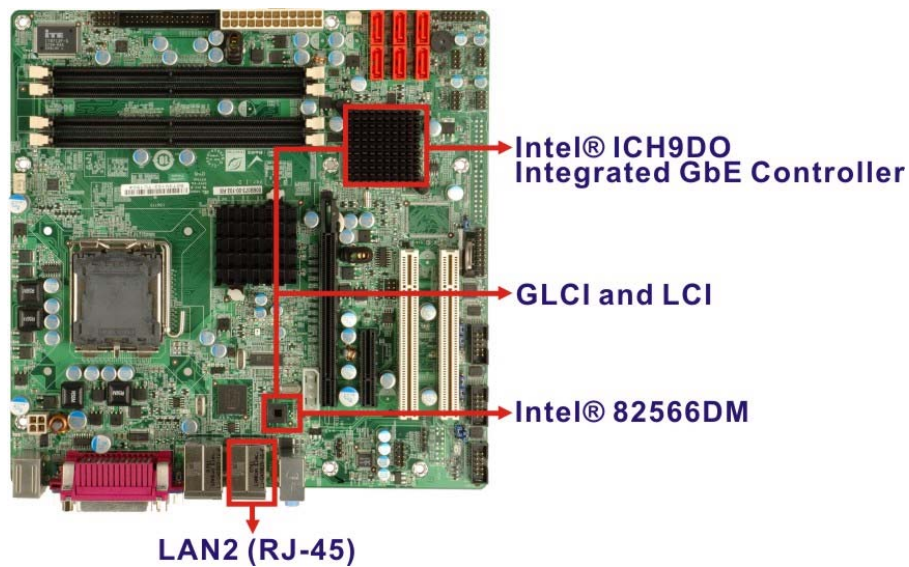

Figure 2-9: Intel® 82566DM Gigabit LAN Connect Device

Some of the features of the Intel® 82556DM are listed below:

- 10 Mbps, 100 Mbps, or 1000 Mbps
- Supports Intel® Active Management Technology
- Supports Intel® Virtualization Technology through the Intel® Virtual Gigabit Network Connection.
- Can support legacy ASF2.0.
- Shared SPI flash with system BIOS
- Integrated linear voltage regulator
- TCP/UDP checksum and segmentation offload
- Receive side scaling
- Dual TX and RX queues
- 802.1p and 802.1q

2.5.5 Intel® ICH9DO Low Pin Count (LPC) Interface

The ICH9DO LPC interface complies with the LPC 1.1 specifications. The LPC bus from the ICH9DO is connected to the following components:

- BIOS chipset
- Super I/O chipset

- Trusted Platform Module (TPM) connector

2.5.6 Intel® ICH9DO PCI Interface

The PCI interface on the ICH9DO is compliant with the PCI Revision 2.3 implementation. Some of the features of the PCI interface are listed below.

- PCI Revision 2.3 compliant
- 33MHz
- 5V tolerant PCI signals (except PME#)
- Integrated PCI arbiter supports up to four PCI bus masters

The PCI bus masters are interfaced to the following onboard components:

- Two PCI sockets

2.5.7 Intel® ICH9DO PCIe x4 Bus

The Intel® ICH9DO Southbridge chipset has six PCIe x1 lanes. The four PCIe lanes are interfaced to one PCIe x4 slot on the IMB-Q354 motherboard.

One of the remaining PCIe x1 lanes is connected to an Intel® 82566DM GbE controller and the other PCIe x1 lane is connected to an Intel® 82573L GbE controller.

For more detailed information, please refer to **Section 2.6.3**.

2.5.8 Intel® ICH9DO Real Time Clock

256 bytes of battery backed RAM is provided by the Motorola MC146818B real time clock (RTC) integrated into the ICH9DO. The RTC operates on a 3V battery and 32.768KHz crystal. The RTC keeps track of the time and stores system data even when the system is turned off.

2.5.9 Intel® ICH9DO SATA Controller



NOTE:

That SATA drive mode is set in the BIOS. Please refer to the **Section 6.3.2 on IDE Configuration on page 115** and **Section 6.3.7 on AHCI Configuration on page 130**.

The ICH9DO SATA supports three modes of operation:

- **Native IDE enabled operating system:** Two controllers enable all six ports on the bus. Controller 1 supports Port 0, Port 1, Port 2 and Port 3. Controller 2 supports Ports 4 and Port 5.
- **Legacy operating system is used:** One controller is enabled and only supports Port 0, Port 1, Port 2 and Port 3.
- **AHCI or RAID mode:** One controller supports all six ports including, Port 0, Port 1, Port 2, Port 3, Port 4 and Port 5.

In the AHCI or RAID mode, 3.0 Gbps data transfer speeds are supported. The SATA drive connectors are shown in **Figure 2-10**.



Figure 2-10: SATA Drive Connectors

2.5.10 Intel® ICH9DO Serial Peripheral Interface (SPI) BIOS

The SPI is connected to an SPI BIOS chip. A licensed copy of AMI BIOS is preinstalled on the SPI BIOS chip.

2.5.11 Intel® ICH9DO USB Controller

2.5.11.1 Intel® ICH9DO USB Controller Overview

The ICH9DO comprises six full/low speed USB controllers that support the standard Universal Host Controller Interface (UHCI) Revision 1.1. Each controller supports two USB devices ensuring up to twelve USB 1.1 devices can be connected to the IMB-Q354.

The ICH9DO also comprises two high-speed Enhanced Host Controller Interface (EHCI) controllers. Each EHCI controller supports six USB 2.0 devices ensuring twelve USB 2.0 devices can be connected to the IMB-Q354. EHCI controllers facilitate data transfer speeds of 480 Mbps

Port routing logic on the ICH9DO determines whether a UHCI or an EHCI controller controls a USB port.

2.5.11.2 IMB-Q354 USB Implementation

All twelve of the Intel® ICH9DO USB ports are implemented on the IMB-Q354. Four USB ports (USB Port 1 to USB Port 4) are connected to four external connectors and eight USB ports (USB Port 5 to USB Port 12) are connected to four 8-pin onboard pin-headers. See **Figure 2-11**.

IMB-Q354 uATX Motherboard

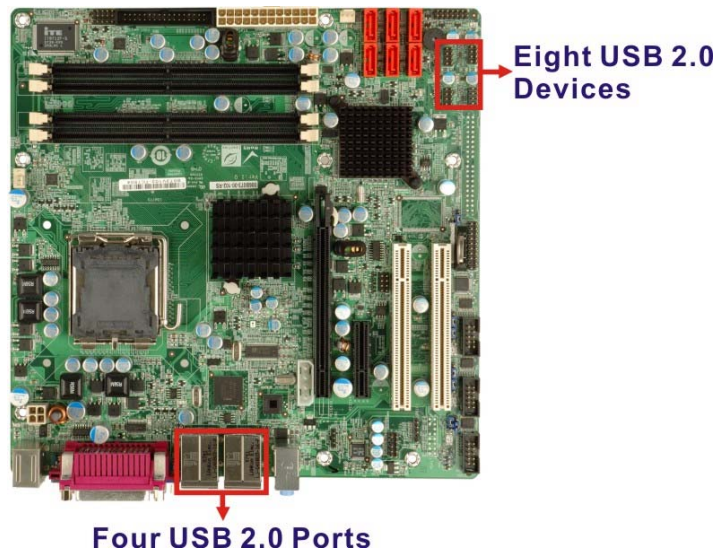

Figure 2-11: Onboard USB Implementation

2.6 IMB-Q354 PCIe Bus Components

2.6.1 PCIe Bus Overview

The IMB-Q354 has one PCIe x16 channel from the Intel® Q35 Northbridge and six PCIe x1 lanes from the Intel® ICH9DO Southbridge. The PCIe bus lanes are interfaced to the following devices.

- One PCIe x16 lane is connected to one PCIe x16 graphics card
- Four PCIe x1 lanes are connected to one PCIe x4 expansion card
- One PCIe x1 lane are connected to one Intel® PCIe GbE device
- One PCIe x1 is shared with the Intel® ICH9DO Gigabit LAN Connect Interface (GLCI), which is connected to a Intel® 82566DM Gigabit platform LAN connect device

2.6.2 PCIe x16 Slot

The Intel® Q35 Northbridge chipset has one PCIe x16 port reserved for a PCIe x16 graphics card. The PCIe x16 lane is interfaced to a PCIe x16 slot on the IMB-Q354 motherboard. The PCIe x16 graphics card is then installed on the PCIe x16 slot on the motherboard. The PCIe x16 edge connector is shown in **Figure 2-12**.

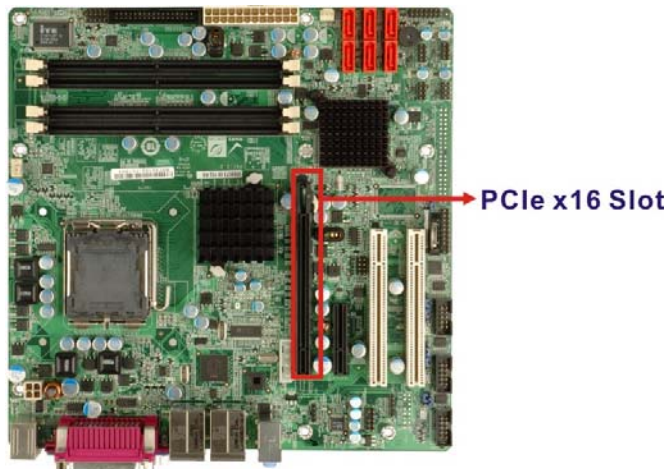

Figure 2-12: PCIe x16 Slot

2.6.3 PCIe x4 Slot

Four of the six PCIe x1 expansion channels on the IMB-Q354 are interfaced to one PCIe x4 slot on the IMB-Q354 motherboard. The PCIe x4 slot is shown in **Figure 2-13**.

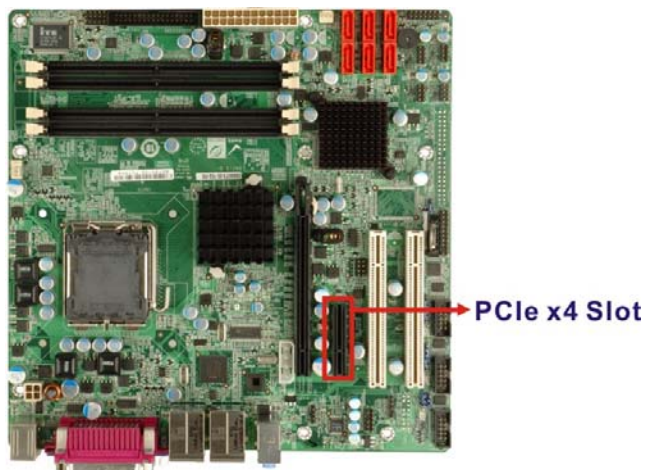

Figure 2-13: PCIe x4 Slot

2.6.4 Intel® 82573L PCIe GbE Controller

An RJ-45 Ethernet LAN connector is interfaced directly to an Intel® 82573L PCIe GbE controller. The Intel® 82573L PCIe GbE controller is a compact, single-port integrated physical layer (PHY) device with its own Memory Access Controller (MAC) and interfaced

IMB-Q354 uATX Motherboard

to the Intel® ICH9DO Southbridge through a PCIe x1 lane. The Intel® 82573L GbE controllers is shown in **Figure 2-14** below.

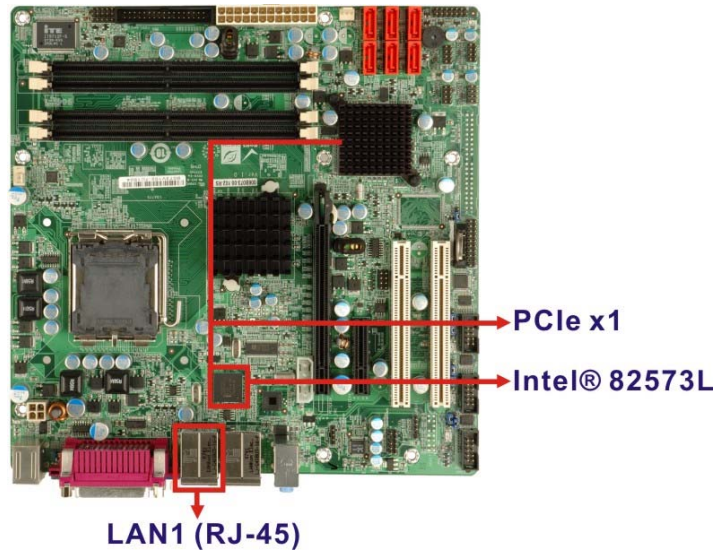

Figure 2-14: Intel® 82573L PCIe GbE Controller

Some of the features of the Intel® 82573L are listed below:

- 2 Gbps peak bandwidth per direction
- PCI Express Rev 1.0a specification
- High bandwidth density per pin
- Wide, pipelined internal data path architecture
- Optimized transmit (Tx) and receive (Rx) queues
- 32 KB configurable Rx and Tx first-in/first-out (FIFO)
- IEEE 802.3x*-compliant flow-control support with software controllable pause times and threshold values
- Programmable host memory Rx buffers (256 B-16 KB)
- Descriptor ring management hardware for Tx and Rx
- Mechanism for reducing interrupts from Tx/Rx operations
- Integrated PHY for 10/100/1000 Mbps (full- and half-duplex)
- IEEE 802.3ab* auto-negotiation support
- IEEE 802.3ab PHY compliance and compatibility
- Tx/Rx IP, TCP, and UDP checksum offloading
- Tx TCP segmentation

- IEEE 802.1q* Virtual Local Area Network (VLAN) support with VLAN tag insertion, stripping, and packet filtering for up to 4096 VLAN tags
- Boot ROM Preboot eXecution Environment (PXE) Flash interface support
- SDG 3.0, WfM 3.0 and PC2001 compliant
- Wake on LAN support

2.7 PCI Bus Components

2.7.1 PCI Bus Overview

The PCI bus is connected to the components listed below:

- Two PCI slots

The PCI bus complies with PCI Local Bus Specification, Revision 2.3 and supports 33MHz PCI operations.

2.7.2 PCI Slots

The Intel® ICH9DO Southbridge integrates a PCI arbiter that supports up to four PCI Masters thereby enabling the IMB-Q354 to support an additional two PCI bus Masters. The PCI bus on the IMB-Q354 is interfaced to two PCI slots thereby connecting the PCI expansion boards to the Intel® ICH9DO Southbridge. The PCI slots are shown in **Figure 2-15**.

IMB-Q354 uATX Motherboard

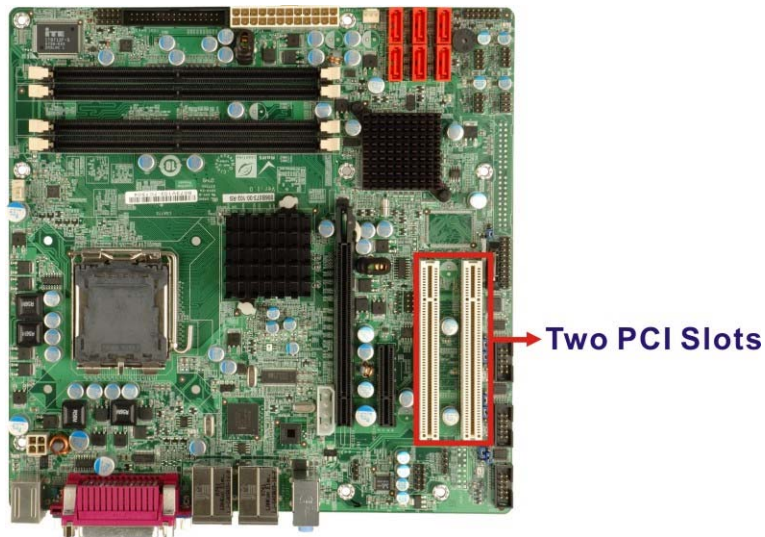

Figure 2-15: PCI Slots

2.8 LPC Bus Components

2.8.1 LPC Bus Overview

The LPC bus is connected to components listed below:

- TPM module connector
- Super I/O chipset
- Fintek F81216DG LPC Serial Port Chipset

2.8.2 TPM Module

A TPM connector on the IMB-Q354 is interfaced to the Intel® ICH9DO Southbridge through the LPC bus. The TPM connector is shown in **Figure 2-16** below.

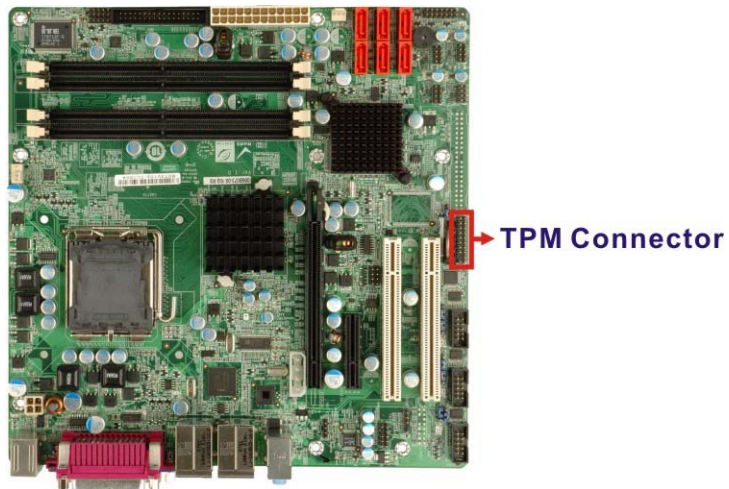

Figure 2-16: TPM Connector

The Intel® ICH9DO Southbridge supports TPM version 1.1 and TPM version 1.2 devices for enhanced security. Three TPM are available from IEI. The three IEI TPM are listed below:

- Infineon TPM module
- Sinosun TPM module
- Winbond TPM module

For more information about these modules please refer to **Chapter 3** or contact the IMB-Q354 reseller or vendor. Alternatively, please contact IEI at sales@iei.com.tw.

2.8.3 Super I/O chipset

The ITE IT8712F Super I/O chipset is connected to the Intel® ICH9DO Southbridge through the LPC bus. ITE IT8712F Super I/O chipset is shown in **Figure 2-17** below.

IMB-Q354 uATX Motherboard

iTE IT8712F
Super I/O



Figure 2-17: ITE IT8712F Super I/O

The ITE IT8712F is an LPC interface-based Super I/O device that comes with an integrated Environment Controller. Some of the features of the ITE IT8712F chipset are listed below:

- PC98/99/2001, ACPI and LANDesk Compliant
- Enhanced Hardware Monitor
- Fan Speed Controller
- Single +5V Power Supply
- Two 16C550 UARTs for serial port control
- One IEEE 1284 Parallel Port
- Keyboard Controller
- Watchdog Timer
- Serial IRQ Support
- Vbat & Vcch Support
- Single +5V Power Supply

Some of the Super I/O features are described in more detail below:

2.8.3.1 Super I/O LPC Interface

The LPC interface on the Super I/O complies with the Intel® Low Pin Count Specification Rev. 1.0. The LPC interface supports both LDRQ# and SERIRQ protocols as well as PCI PME# interfaces.

2.8.3.2 Super I/O 16C550 UARTs

The onboard Super I/O has two integrated 16C550 UARTs that can support the following:

- one standard serial port (COM1)
- IrDa 1.0 and ASKIR protocols(IR1)

The Fintek F81216DG LPC Serial Port chipset connected to the LPC bus provided connectivity to another three serial port connectors (COM2, COM3 and COM4). For further details on the Fintek F81216DG serial port controller, please refer to **Section 2.8.4**.

2.8.3.3 Super I/O Enhanced Hardware Monitor

The Super I/O Enhanced Hardware Monitor monitors three thermal inputs, VBAT internally, and eight voltage monitor inputs. These hardware parameters are reported in the BIOS and can be read from the BIOS Hardware Health Configuration menu.

2.8.3.4 Super I/O Floppy Disk Drive (FDD) Controller

The Super I/O FDD controller is compatible with the following specifications.

- Enhanced digital data separator
- Supports automatic write protection via software
- Supported capacities:
 - 360K
 - 720K
 - 1.2M
 - 1.44M
 - 2.88M
- 3-mode FDD supported

IMB-Q354 uATX Motherboard

The FDD controller is interfaced to a FDD connected to the FDD connector on the IMB-Q354.

2.8.3.5 Super I/O Fan Speed Controller

The Super I/O fan speed controller enables the system to monitor the speed of the fan. One of the pins on the fan connector is reserved for fan speed detection and interfaced to the fan speed controller on the Super I/O. The fan speed is then reported in the BIOS.

2.8.3.6 Super I/O Keyboard/Mouse Controller

The Super I/O keyboard/mouse controller can execute the 8042 instruction set. Some of the keyboard controller features are listed below:

- The 8042 instruction is compatible with a PS/2 keyboard and PS/2 mouse
- Gate A20 and Keyboard reset output
- Supports multiple keyboard power on events

Supports mouse double-click and/or mouse move power on events.

2.8.3.7 Super I/O GPIO Ports

The Super I/O has 48 programmable GPIO ports of which 8 are implemented on the IMB-Q354. The GPIO connector has 8 programmable bits, 4-bit input and 4-bit output.

2.8.3.8 Super I/O Infrared

The Super I/O has dedicated infrared (IrDA) pins that are interfaced to an IrDA connector.

The IrDA connector is compatible with the following standards:

- ASKIR
- SIR

2.8.3.9 Super I/O Parallel Port

The Super I/O parallel port (LPT) is compatible with the following LPT specifications.

- SPP compatible bi-directional parallel port

- Enhanced Parallel Port (EPP) mode supported. Compatible with IEEE 1284 specifications
- Extended Capability Port (ECP) mode supported. Compatible with IEEE 1284 specifications
- Enhanced printer port back-drive current reduction
- Printer power-on damage reduction
- Supports POST (Power-On Self Test) Data Port

The parallel port controller is connected to an external DB-26 LPT connector.

2.8.3.10 Super I/O Watchdog Timer

The super I/O watchdog timer has a maximum time resolution of 1 minute or 1 second with a maximum of either 65,535 minutes or 65,535 seconds.

2.8.4 Fintek F81216DG LPC Serial Port Chipset

The Fintek F81216DG chipset enables the addition of three additional UART serial ports (COM2, COM3 and COM4). UART includes 16-byte send/receive FIFO. The Fintek serial port chipset is interfaced to the Southbridge chipset through the LPC bus. Some of the features of the Fintek chipset are listed below:

- Supports LPC interface
- Totally provides 4 UART (16550 asynchronous) ports
 - 3 x Pure UART
 - 1 x UART+IR
- One Watch dog timer with WDTOUT# signal
- One Frequency input 48MHz
- Powered by 3Vcc

2.9 Ethernet LAN Controllers

The IMB-Q354 motherboard has two GbE controllers. The IMB-Q354 LAN connections are shown in **Figure 2-18**.

IMB-Q354 uATX Motherboard

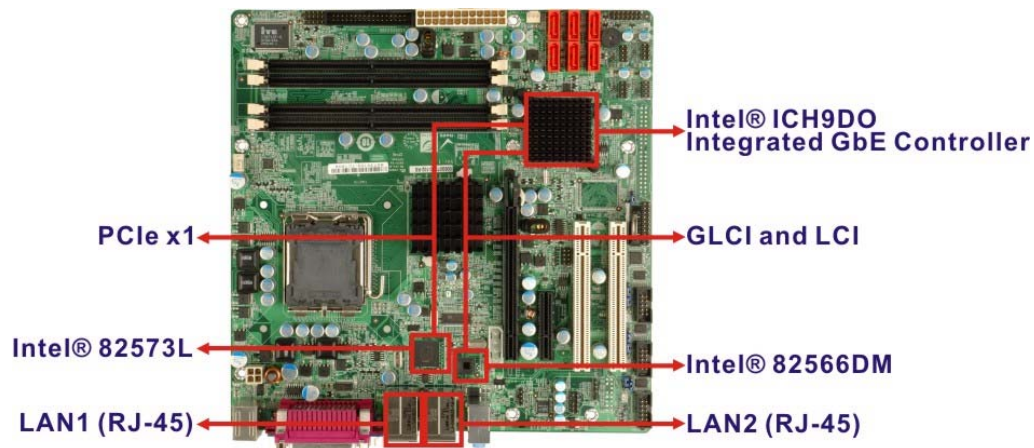

Figure 2-18: LAN Connections

The first GbE controller, is an Intel® 82537L PCIe GbE controller and is the interface between the Intel® ICH9DO Southbridge controller and the LAN1 RJ-45 Ethernet connector.

The second GbE controller is integrated on the Intel® ICH9DO Southbridge and interfaced to the LAN2 RJ-45 Ethernet LAN connector through an Intel® 82566DM Gigabit Platform LAN Connect device. The Intel® 82566DM is connected directly to the GbE controller on the Intel® ICH9DO Southbridge through the GLCI and LCI, which is shared with the PCIe x1 port 6.

Both of these Ethernet controllers have been described in detail in earlier sections. For further details please refer to the relevant sections:

- Intel® ICH9DO Ethernet controller (**Section 2.5.4**)
- Intel® 82566DM Gigabit Platform LAN Connect device (**Section 2.5.4.1**)
- Intel® 82537L PCIe GbE controller (**Section 2.6.4**)

2.10 Environmental and Power Specifications

2.10.1 System Monitoring

Three thermal inputs on the IMB-Q354 Super I/O Enhanced Hardware Monitor monitor the following temperatures:

- System Temperature #1
- System Temperature #2

Five voltage inputs on the IMB-Q354 Super I/O Enhanced Hardware Monitor monitors the following voltages:

- CPU Core
- DDR2 1.8V
- +3.3V
- +5V
- +12V
- FSB 1.2V
- +1.5V
- +1.25V
- VBAT

The IMB-Q354 Super I/O Enhanced Hardware Monitor also monitors the following fan speeds:

- CPU Fan Speed
- System Fan Speed

The values for the above environmental parameters are all recorded in the BIOS Hardware Health Configuration menu.

2.10.2 Operating Temperature and Temperature Control

The maximum and minimum operating temperatures for the IMB-Q354 are listed below.

- Minimum Operating Temperature: 0°C (32°F)

IMB-Q354 uATX Motherboard

- Maximum Operating Temperature: 60°C (140°F)

A cooling fan and heat sink must be installed on the CPU. Thermal paste must be smeared on the lower side of the heat sink before it is mounted on the CPU. Heat sinks are also mounted on the Northbridge and Southbridge chipsets to ensure the operating temperature of these chips remain low.

2.10.3 Power Consumption

Table 2-3 shows the power consumption parameters for the IMB-Q354 running 3D Mark® 2001 SE330 with a 3.0 GHz E6850 Intel® Core™2 Duo processor with four 2.0 GB 800MHz DDR2 DIMMs.

Voltage	Current
+3.3V	2.41A
+5.0V	5.71A
+12V	3.69A
5Vsb	0.13A

Table 2-3: Power Consumption

THIS PAGE IS INTENTIONALLY LEFT BLANK

Chapter

3

Unpacking

3.1 Anti-static Precautions



WARNING:

Failure to take ESD precautions during the installation of the IMB-Q354 may result in permanent damage to the IMB-Q354 and severe injury to the user.

Electrostatic discharge (ESD) can cause serious damage to electronic components, including the IMB-Q354. Dry climates are especially susceptible to ESD. It is therefore critical that whenever the IMB-Q354, or any other electrical component is handled, the following anti-static precautions are strictly adhered to.

- **Wear an anti-static wristband:** Wearing a simple anti-static wristband can help to prevent ESD from damaging the board.
- **Self-grounding:** Before handling the board touch any grounded conducting material. During the time the board is handled, frequently touch any conducting materials that are connected to the ground.
- **Use an anti-static pad:** When configuring the IMB-Q354, place it on an anti-static pad. This reduces the possibility of ESD damaging the IMB-Q354.
- **Only handle the edges of the PCB:** When handling the PCB, hold the PCB by the edges.

3.2 Unpacking

3.2.1 Unpacking Precautions

When the IMB-Q354 is unpacked, please do the following:

- Follow the anti-static precautions outlined in **Section 3.1**.
- Make sure the packing box is facing upwards so the IMB-Q354 does not fall out of the box.
- Make sure all the components shown in **Section 3.3** are present.

IMB-Q354 uATX Motherboard

3.3 Unpacking Checklist







NOTE:

If some of the components listed in the checklist below are missing, please do not proceed with the installation. Contact the IEI reseller or vendor you purchased the IMB-Q354 from or contact an IEI sales representative directly. To contact an IEI sales representative, please send an email to sales@iei.com.tw.

3.3.1 Package Contents



The IMB-Q354 is shipped with the following components:

Quantity	Item and Part Number	Image
1	IMB-Q354 motherboard	
1	Dual RS-232 cable (P/N: 19800-000051-RS)	
6	SATA cables (P/N: 32000-062800-RS)	
3	SATA power cables (P/N: 32100-088600-RS)	

1	Mini jumper Pack	
1	Quick Installation Guide	
1	Utility CD	
1	USB cable (P/N: CB-USB02-RS)	

Table 3-1: Package List Contents

3.4 Optional Items

CPU cooling kit (P/N: CF-520-RS)	
CPU cooling kit (P/N: CF-775A-RS)	

IMB-Q354 uATX Motherboard



<p>Infineon TPM module (P/N: TPM-IN01-R10)</p>	
<p>Sinosun TPM module (P/N: TPM-SI01-R10)</p>	
<p>Winbond TPM module (P/N: TPM-WI01-R10)</p>	

Table 3-2: Package List Contents

THIS PAGE IS INTENTIONALLY LEFT BLANK

Chapter

4

Connector Pinouts

4.1 Peripheral Interface Connectors

Section 4.1.2 shows peripheral interface connector locations. Section 4.1.2 lists all the peripheral interface connectors seen in Section 4.1.2.

4.1.1 IMB-Q354 Layout

Figure 4-1 shows the on-board peripheral connectors, rear panel peripheral connectors and on-board jumpers.

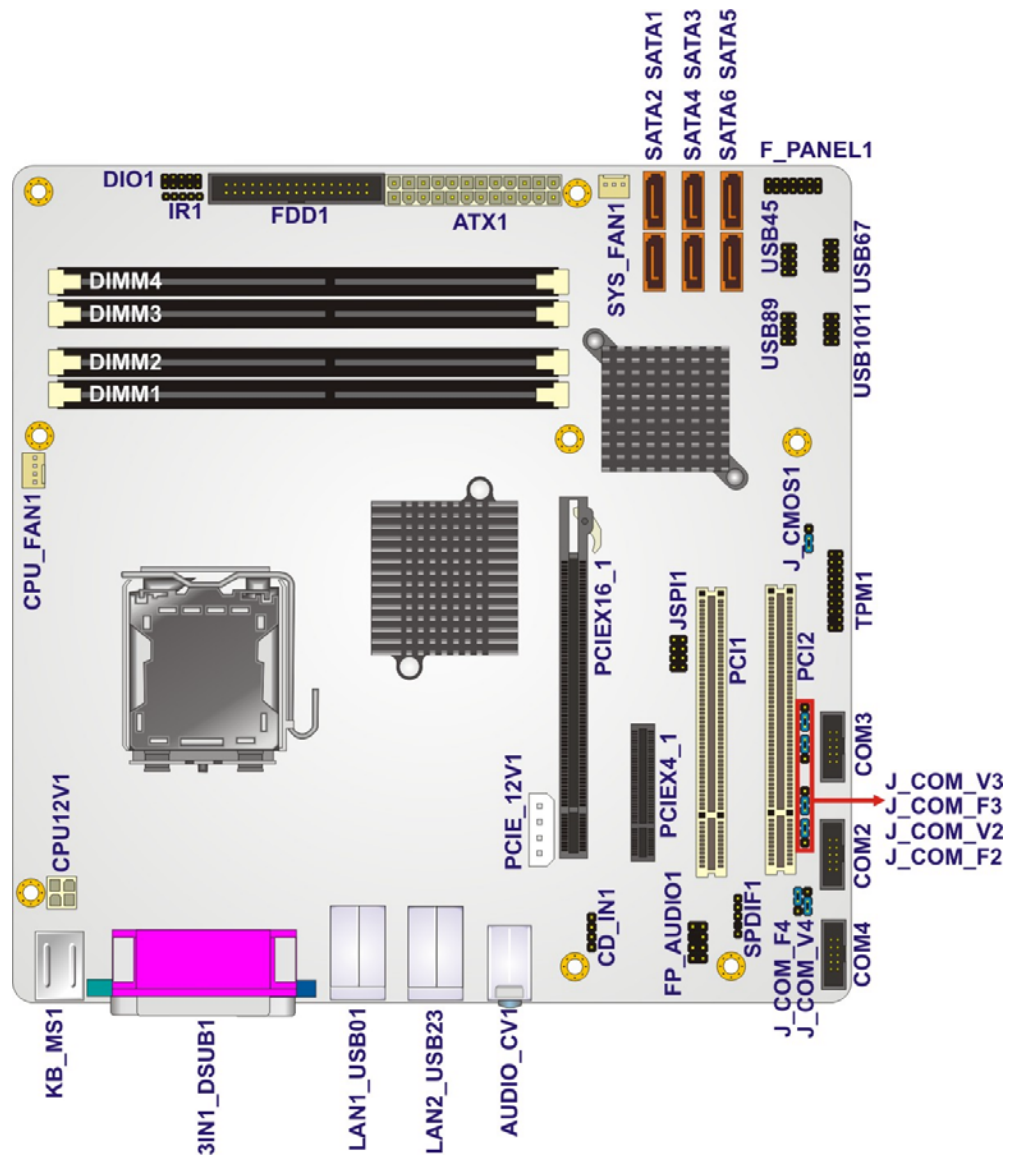

Figure 4-1: Connector and Jumper Locations

4.1.2 Peripheral Interface Connectors

Table 4-1 shows a list of the peripheral interface connectors on the IMB-Q354. Detailed descriptions of these connectors can be found below.

Connector	Type	Label
ATX power connector	24-pin ATX connector	ATX1
CD in connector	4-pin header	CD_IN1
Cooling fan connector, CPU	4-pin wafer	CPU_FAN1
Cooling fan connector, System	3-pin wafer	SYS_FAN1
CPU power connector	4-pin wafer	CPU12V1
Digital input/output connector	10-pin header	DIO1
DIMM socket	240-pin socket	DIMM1
DIMM socket	240-pin socket	DIMM2
DIMM socket	240-pin socket	DIMM3
DIMM socket	240-pin socket	DIMM4
Floppy drive connector	34-pin box header	FDD1
Front audio connector	10-pin header	FP_AUDIO1
Front panel connector	14-pin header	F_PANEL1
Infrared (IrDA) connector	5-pin header	IR1
PCI socket	120-pin slot	PCI1
PCI socket	120-pin slot	PCI2
PCIe x16 socket	164-pin slot	PCIEX16
PCIe x4 socket	64-pin slot	PCIEX4
PCIe power connector	4-pin wafer	PCIE_12V1

Serial ATA drive connector	7-pin SATA	SATA1
Serial ATA drive connector	7-pin SATA	SATA2
Serial ATA drive connector	7-pin SATA	SATA3
Serial ATA drive connector	7-pin SATA	SATA4
Serial ATA drive connector	7-pin SATA	SATA5
Serial ATA drive connector	7-pin SATA	SATA6
Serial port connector (COM2)	10-pin box header	COM2
Serial port connector (COM3)	10-pin box header	COM3
Serial port connector (COM4)	10-pin box header	COM4
SPDIF connector	5-pin header	SPDIF1
SPI flash connector	8-pin header	JSPI1
TPM connector	20-pin header	TPM1
USB connector	8-pin header	USB45
USB connector	8-pin header	USB67
USB connector	8-pin header	USB89
USB connector	8-pin header	USB1011

Table 4-1: Peripheral Interface Connectors

4.1.3 External Interface Panel Connectors

Table 4-2 lists the rear panel connectors on the IMB-Q354. Detailed descriptions of these connectors can be found in **Section 4.3**.

IMB-Q354 uATX Motherboard

Connector	Type	Label
Audio connector	Audio jack	AUDIO_CV1
Ethernet and dual USB combo connector	RJ-45 and two USB	LAN1_USB01
Ethernet and dual USB combo connector	RJ-45 and two USB	LAN2_USB23
Mouse or keyboard connector	PS/2	KB_MS1
Parallel port, serial port and VGA combo connector	DB-25, DB-9 and DB-15	3IN1_DSUB1

Table 4-2: Rear Panel Connectors

4.2 Internal Peripheral Connectors

Internal peripheral connectors are found on the motherboard and are only accessible when the motherboard is outside of the chassis. This section has complete descriptions of all the internal, peripheral connectors on the IMB-Q354.

4.2.1 ATX Power Connector

- CN Label:** ATX1
- CN Type:** 24-pin ATX (2x12)
- CN Location:** See **Figure 4-2**
- CN Pinouts:** See **Table 4-3**

The ATX connector is connected to an external ATX power supply. Power is provided to the system, from the power supply through this connector.

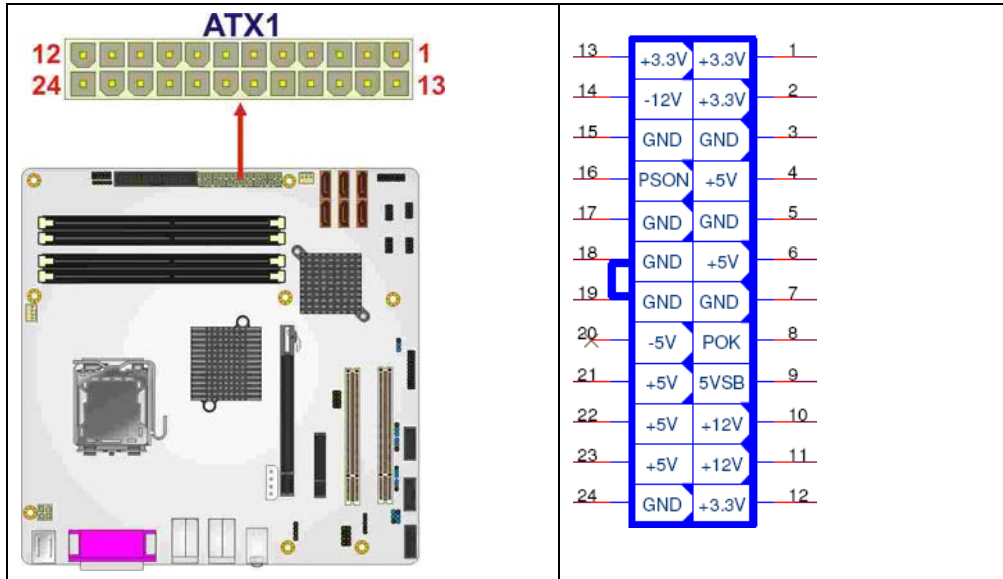

Figure 4-2: ATX Power Connector Pinout Locations

PIN NO.	DESCRIPTION	PIN NO.	DESCRIPTION
1	3.3V	13	3.3V
2	3.3V	14	-12V
3	GND	15	GND
4	+5V	16	PS_ON
5	GND	17	GND
6	+5V	18	GND
7	GND	19	GND
8	Power good	20	-5V
9	5VSB	21	+5V
10	+12V	22	+5V
11	+12V	23	+5V
12	3.3V	24	GND

Table 4-3: ATX Power Connector Pinouts

IMB-Q354 uATX Motherboard

4.2.2 Audio CD In Connector

CN Label:	CD_IN1
CN Type:	4-pin header
CN Location:	See Figure 4-3
CN Pinouts:	See Table 4-4

The 4-pin audio CD in connector is connected to an external audio CD device for the input and output of audio signals from a CD player to the system.

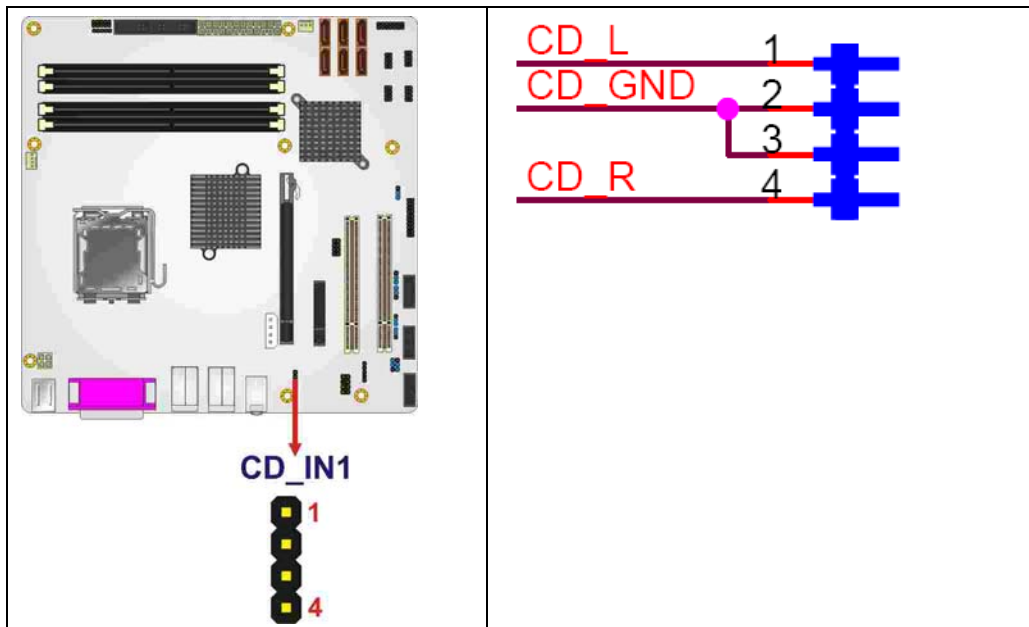

Figure 4-3: Audio CD In Connector Pinouts (4-pin)

PIN NO.	DESCRIPTION
1	CD Signal (Left)
2	Ground
3	Ground
4	CD Signal (Right)

Table 4-4: Audio CD In Connector Pinouts

4.2.3 CPU Power Connector

- CN Label:** CPU12V1
- CN Type:** 4-pin power connector (1x4)
- CN Location:** See **Figure 4-4**
- CN Pinouts:** See **Table 4-5**

The 4-pin CPU power connector is connected to an ATX power supply and powers the CPU.

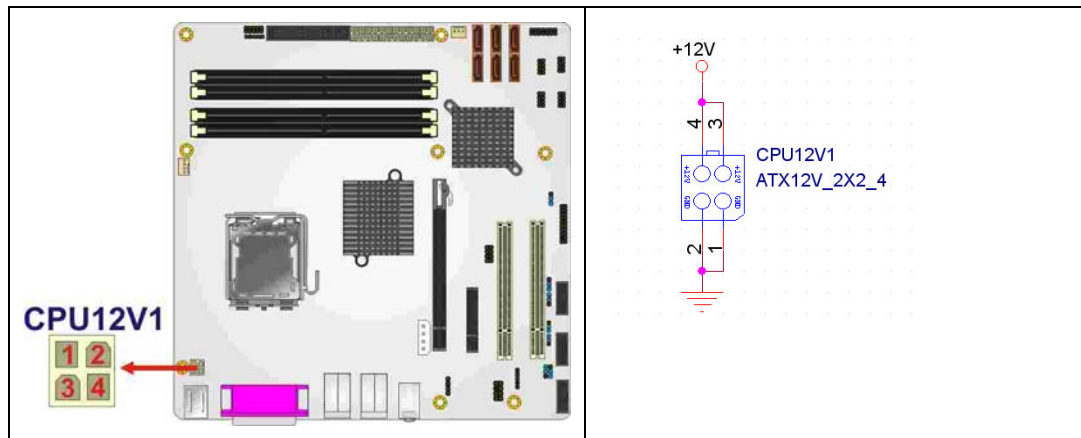

Figure 4-4: CPU Power Connector Location

PIN NO.	DESCRIPTION
1	GND
2	GND
3	+12V
4	+12V

Table 4-5: CPU Power Connector Pinouts

4.2.4 Digital Input/Output (DIO) Connector

- CN Label:** DIO1
- CN Type:** 10-pin header (2x5)

IMB-Q354 uATX Motherboard

CN Location: See Figure 4-5

CN Pinouts: See Table 4-6

The digital input/output connector is managed through a Super I/O chip. The DIO connector pins are user programmable. To see details on how to program the DIO chip, please refer to **Appendix C**.

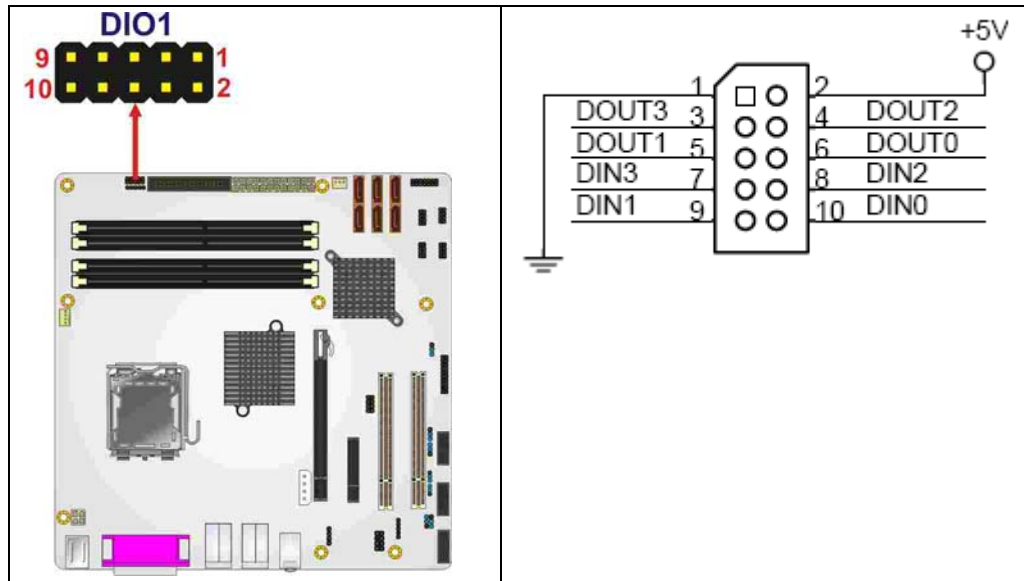

Figure 4-5: DIO Connector Location

PIN NO.	DESCRIPTION	PIN NO.	DESCRIPTION
1	Ground	2	VCC
3	Output 3	4	Output 2
5	Output 1	6	Output 0
7	Input 3	8	Input 2
9	Input 1	10	Input 0

Table 4-6: DIO Connector Pinouts

4.2.5 Fan Connector, CPU (12V, 4-pin)

- CN Label:** CPU_FAN1
- CN Type:** 4-pin header (1x4)
- CN Location:** See **Figure 4-6**
- CN Pinouts:** See **Table 4-7**

The CPU cooling fan connector provides a 12V, 500mA current to a CPU cooling fan. The connector has a "rotation" pin to get rotation signals from fans and notify the system so the system BIOS can recognize the fan speed. Please note that only specified fans can issue the rotation signals.

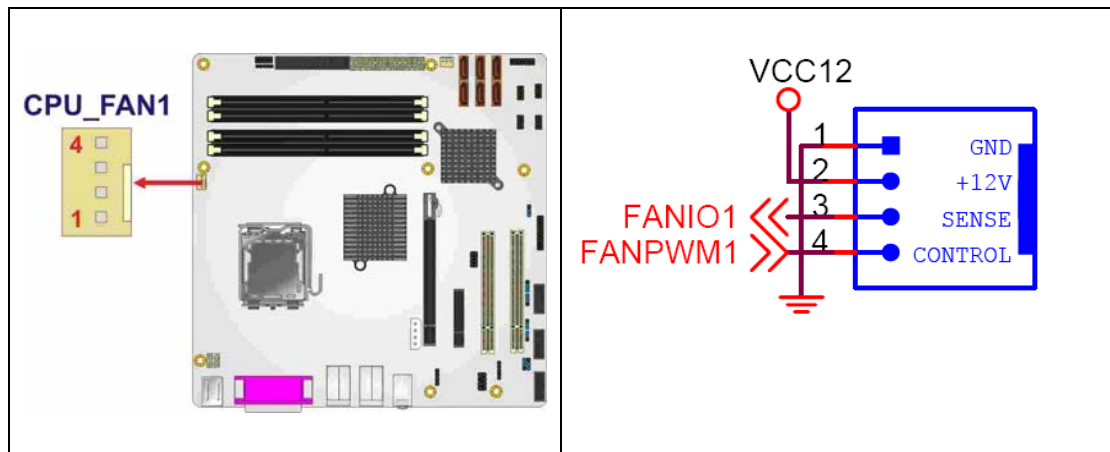

Figure 4-6: +12V Fan Connector Location

PIN NO.	DESCRIPTION
1	GND
2	+12VCC
3	Rotation Signal
4	Control

Table 4-7: +12V Fan Connector Pinouts

IMB-Q354 uATX Motherboard

4.2.6 Fan Connector, System (+12V, 3-pin)

- CN Label:** SYS_FAN1
- CN Type:** 3-pin header (1x3)
- CN Location:** See **Figure 4-7**
- CN Pinouts:** See **Table 4-8**

The system cooling fan connector provides a 12V, 500mA current to a system cooling fan. The connector has a "rotation" pin to get rotation signals from fans and notify the system so the system BIOS can recognize the fan speed. Please note that only specified fans can issue the rotation signals.

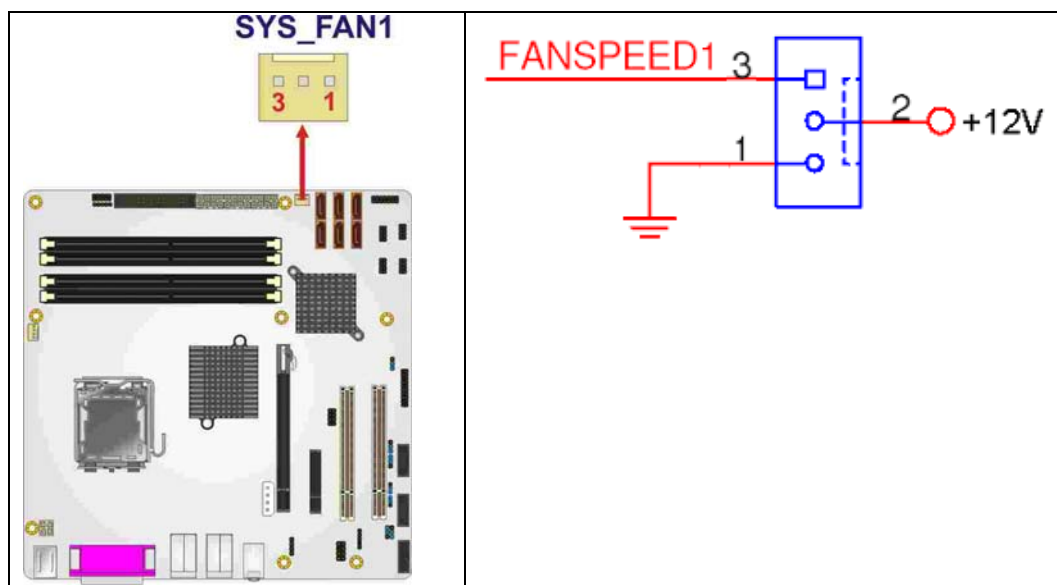

Figure 4-7: +12V Fan Connector Location

PIN NO.	DESCRIPTION
1	GND
2	+12V
3	Rotation Signal

Table 4-8: +12V Fan Connector Pinouts

4.2.7 Floppy Disk Connector (34-pin)

- CN Label:** FDD1
- CN Type:** 34-pin header (2x17)
- CN Location:** See **Figure 4-8**
- CN Pinouts:** See **Table 4-9**

The floppy disk connector is connected to a floppy disk drive.

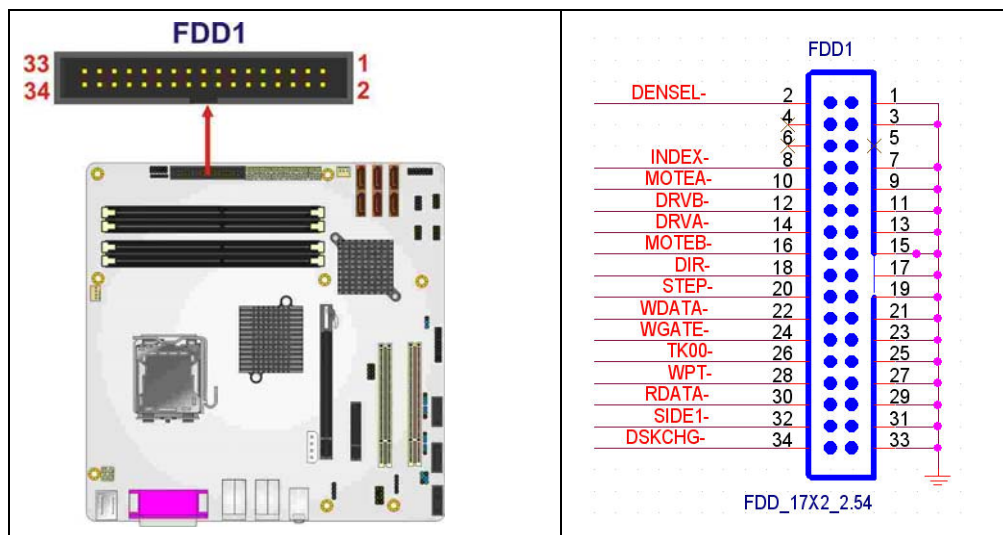

Figure 4-8: 34-pin FDD Connector Location

PIN NO.	DESCRIPTION	PIN NO.	DESCRIPTION
1	GND	2	Density Select#
3	GND	4	N/C
5	N/C	6	N/C
7	GND	8	INDEX#
9	GND	10	MOTOR ENABLE A#
11	GND	12	DRIVE ENABLE B#
13	GND	14	DRIVE ENABLE A#
15	GND	16	MOTOR ENABLE B#
17	GND	18	DIRECTION#

IMB-Q354 uATX Motherboard

19	GND	20	STEP#
21	GND	22	WRITE DATA#
23	GND	24	WRITE GATE#
25	GND	26	TRACK 0#
27	GND	28	WRITE PROTECT#
29	GND	30	READ DATA#
31	GND	32	SIDE 1 SELECT#
33	GND	34	DISK CHANGE#

Table 4-9: 34-pin FDD Connector Pinouts

4.2.8 Front Audio Connector

- CN Label:** FP_AUDIO1
- CN Type:** 10-pin header (2x5)
- CN Location:** See Figure 4-9
- CN Pinouts:** See Table 4-10

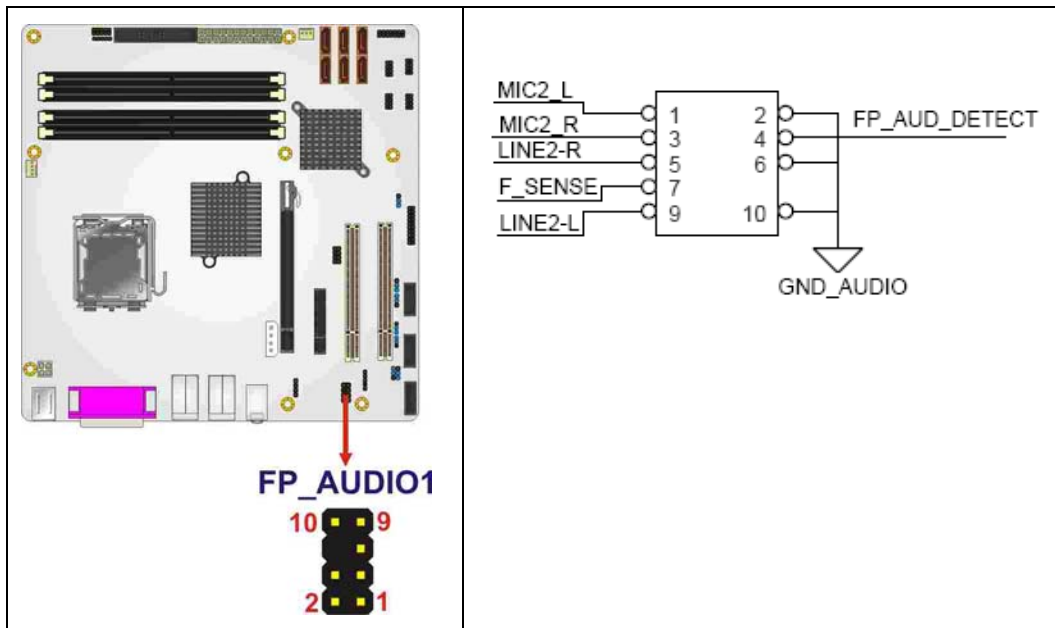

Figure 4-9: Front Audio Connector Location (10-pin)

PIN NO.	DESCRIPTION	PIN NO.	DESCRIPTION
1	MIC_L	2	GND
3	MIC_R	4	Audio Detect
5	LINE2-R	6	GND
7	Jack Detection	8	N/C
9	LINE2-L	10	GND

Table 4-10: Front Audio Connector Pinouts

4.2.9 Front Panel Connector

- CN Label:** F_PANEL1
- CN Type:** 14-pin header (2x7)
- CN Location:** See **Figure 4-10**
- CN Pinouts:** See **Table 4-11**

The front panel connector connects to external switches and indicators to monitor and controls the motherboard. These indicators and switches include:

- Power LED
- Speaker
- Power button
- Reset
- HDD LED

IMB-Q354 uATX Motherboard

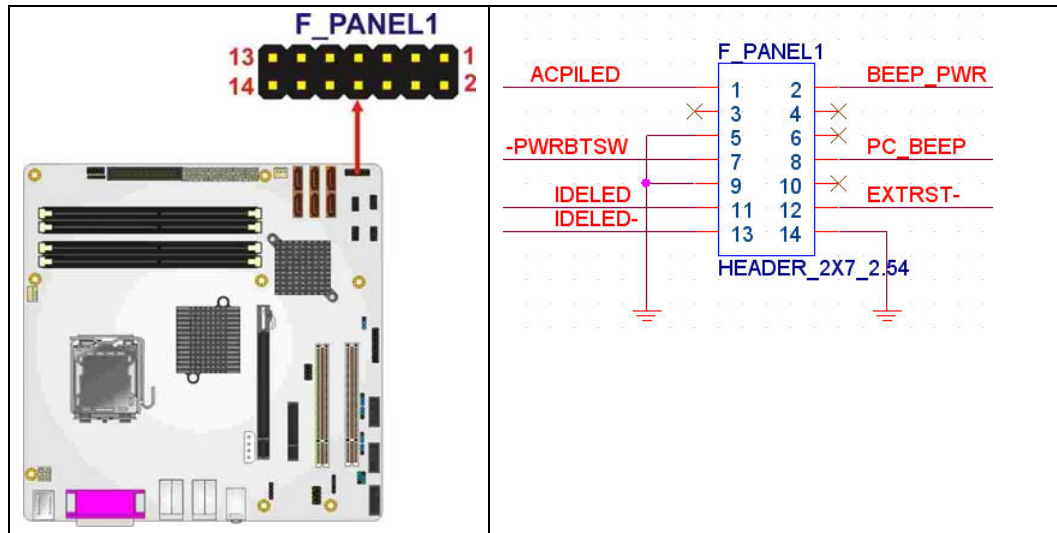

Figure 4-10: Front Panel Connector Pinout Locations (14-pin)

FUNCTION	PIN	DESCRIPTION	FUNCTION	PIN	DESCRIPTION
Power LED	1	+5V	Speaker	2	+5V
	3	N/C		4	N/C
	5	GROUND		6	N/C
7	PWRBTN+	8		SPEAKER	
Button	9	PWRBTN-	Reset	10	N/C
HDD LED	11	+5V		12	RESET-
	13	IDE LED-		14	GROUND

Table 4-11: Front Panel Connector Pinouts (14-pin)

4.2.10 Infrared Interface Connector

- CN Label:** IR1
- CN Type:** 5-pin header (1x5)
- CN Location:** See **Figure 4-11**
- CN Pinouts:** See **Table 4-12**

The infrared interface connector supports both Serial Infrared (SIR) and Amplitude Shift Key Infrared (ASKIR) interfaces.

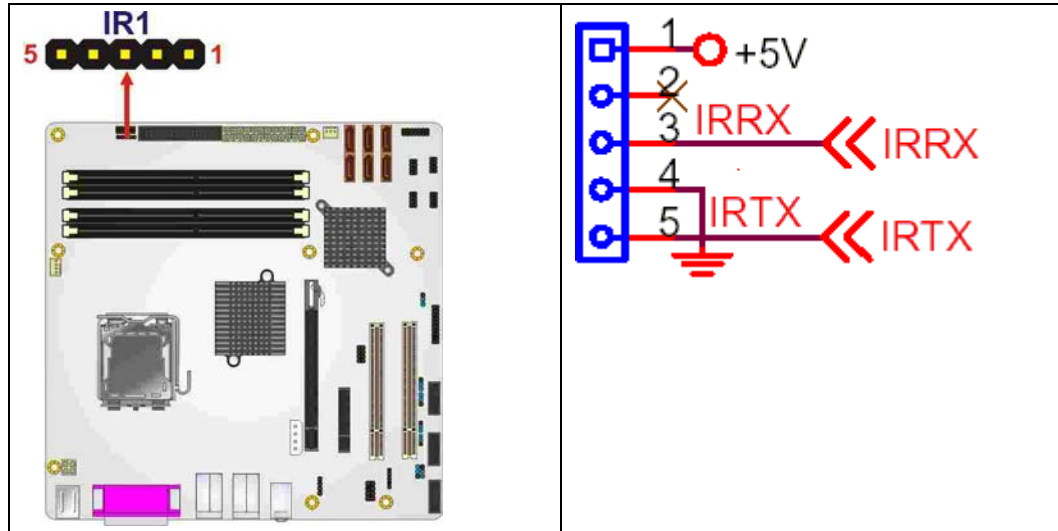
Figure 4-11: Infrared Connector Location

PIN NO.	DESCRIPTION
1	VCC
2	NC
3	IR-RX
4	GND
5	IR-TX

Table 4-12: Infrared Connector Pinouts

4.2.11 PCIe Power Connector

- CN Label:** PCIE_12V1
- CN Type:** 4-pin wafer (1x4)
- CN Location:** See **Figure 4-12**
- CN Pinouts:** See **Table 4-13**

The 4-pin PCIe power connector is connected to a power supply to power the PCIe expansion card.

IMB-Q354 uATX Motherboard

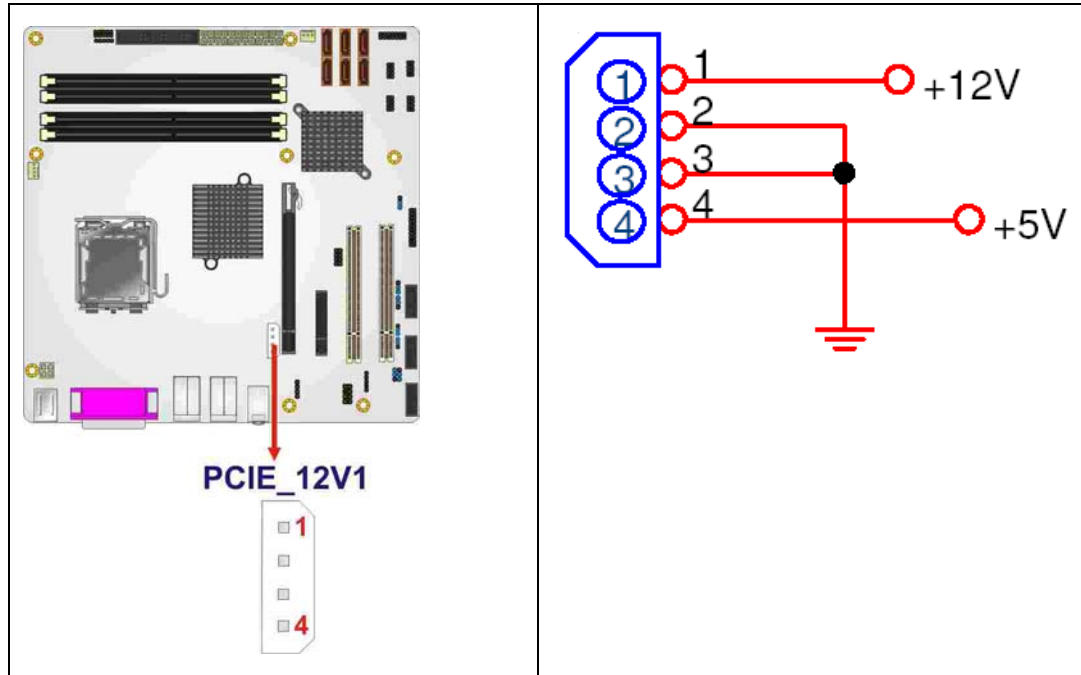

Figure 4-12: PCIe Power Connector Location

PIN NO.	DESCRIPTION
1	+12V
2	GND
3	GND
4	+5V

Table 4-13: PCIe Power Connector Pinouts

4.2.12 SATA Drive Connectors

CN Label: SATA1, SATA2, SATA3, SATA4, SATA5 and SATA6

CN Type: 7-pin SATA drive connectors (1x7)

CN Location: See Figure 4-13

CN Pinouts: See Table 4-14

The six SATA drive connectors are each connected to second generation SATA drives. Second generation SATA drives transfer data at speeds as high as 3.0 Gbps. The SATA drives can be configured in a RAID configuration.

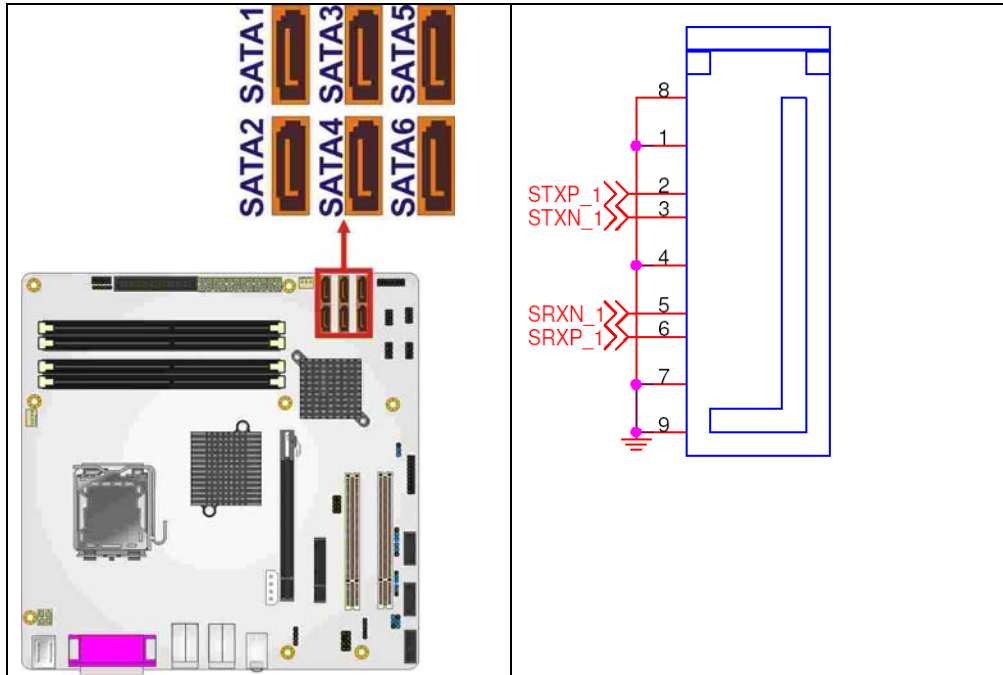

Figure 4-13: SATA Drive Connector Locations

PIN NO.	DESCRIPTION
1	GND
2	TX+
3	TX-
4	GND
5	RX-
6	RX+
7	GND

Table 4-14: SATA Drive Connector Pinouts

IMB-Q354 uATX Motherboard

4.2.13 Serial Port Connector (COM2, COM 3 and COM4)

CN Label: COM2, COM3 and COM4

CN Type: 10-pin header (2x5)

CN Location: See Figure 4-14

CN Pinouts: See Table 4-15

The 10-pin serial port connector provides a second RS-232 serial communications channel. The serial port connectors can be connected to external RS-232 serial port devices.

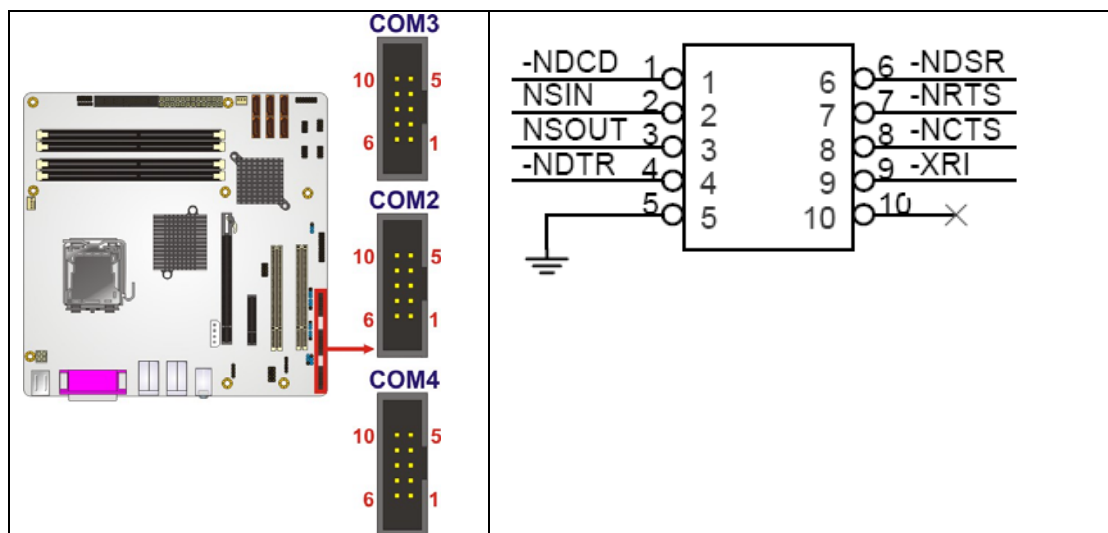

Figure 4-14: Serial Connector Location

PIN NO.	DESCRIPTION	PIN NO.	DESCRIPTION
1	Data Carrier Direct (DCD)	2	Data Set Ready (DSR)
3	Receive Data (RXD)	4	Request To Send (RTS)
5	Transmit Data (TXD)	6	Clear To Send (CTS)
7	Data Terminal Ready (DTR)	8	Ring Indicator (RI)
9	Ground (GND)	10	N/C

Table 4-15: Serial Connector Pinouts

4.2.14 SPDIF Connector

- CN Label:** SPDIF1
- CN Type:** 5-pin header (1x5)
- CN Location:** See **Figure 4-15**
- CN Pinouts:** See **Table 4-16**

Use the SPDIF connector to connect digital audio devices to the system.

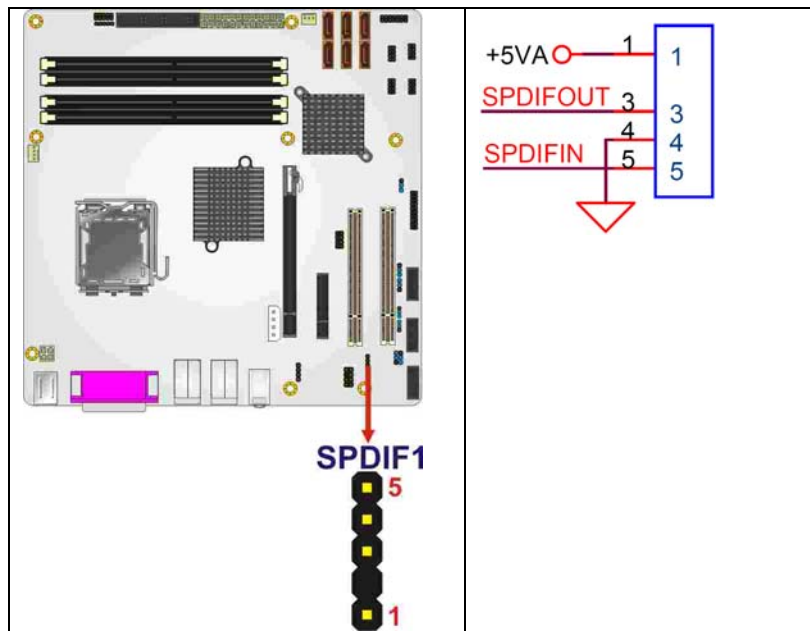

Figure 4-15: SPDIF Connector Location

PIN	DESCRIPTION
1	5V
2	NC
3	SPDIF OUT
4	GND
5	SPDIF IN

Table 4-16: SPDIF Connector Pinouts

IMB-Q354 uATX Motherboard

4.2.15 Trusted Platform Module (TPM) Connector

- CN Label:** TPM1
- CN Type:** 40-pin header (2x20)
- CN Location:** See **Figure 4-16**
- CN Pinouts:** See **Table 4-17**

The Trusted Platform Module (TPM) connector secures the system on bootup. An optional TPM (see packing list in **Chapter 3**) can be connected to the TPM connector.

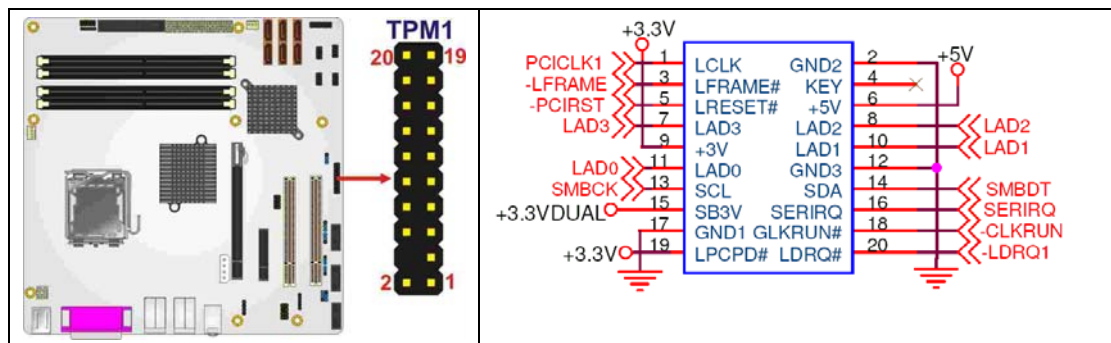

Figure 4-16: TPM Connector Location

PIN NO.	DESCRIPTION	PIN NO.	DESCRIPTION
1	FWHPCLK	2	GND
3	LFRAME#	4	KEY
5	PCIRST#	6	VCC
7	LAD3	8	LAD2
9	VCC3	10	LAD1
11	LAD0	12	GND
13	SMBCLK	14	SMBDATA
15	3VDUAL	16	SERIRQ
17	GND	18	CLKRUN#
19	LPCPD#	20	LDRQ#

Table 4-17: TPM Connector Pinouts

4.2.16 USB Connectors (Internal)

CN Label: USB45, USB67, USB89 and USB1011

CN Type: 8-pin header (2x4)

CN Location: See Figure 4-17

CN Pinouts: See Table 4-18

The 2x4 USB pin connectors each provide connectivity to two USB 1.1 or two USB 2.0 ports. Each USB connector can support two USB devices. Additional external USB ports are found on the rear panel. The USB ports are used for I/O bus expansion.

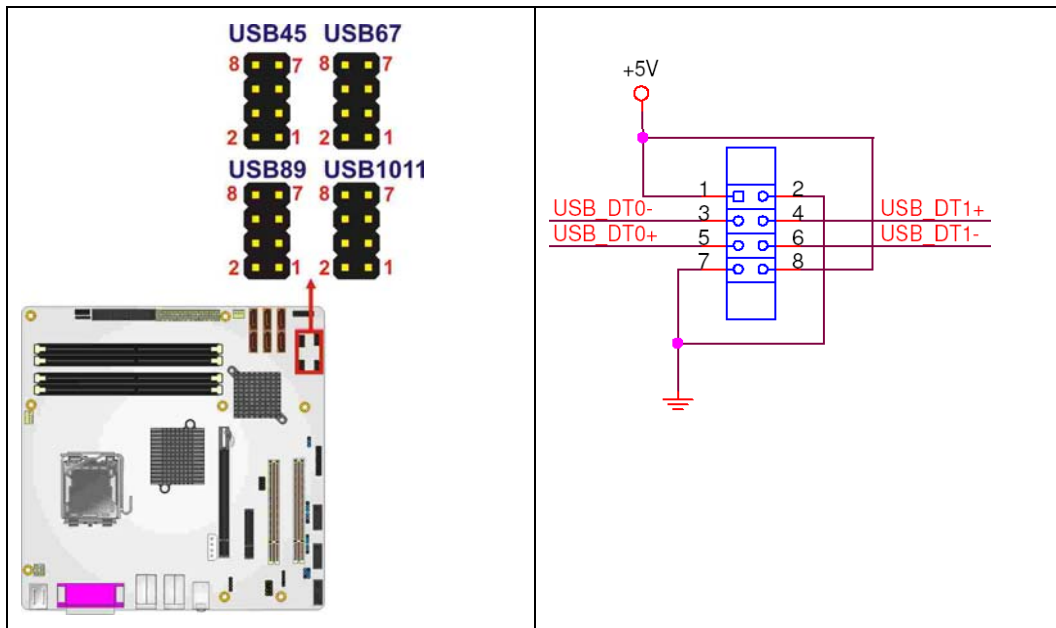

Figure 4-17: USB Connector Locations

PIN NO.	DESCRIPTION	PIN NO.	DESCRIPTION
1	VCC	2	GND
3	DATA-	4	DATA+
5	DATA+	6	DATA-
7	GND	8	VCC

Table 4-18: USB Port Connector Pinouts

4.3 External Peripheral Interface Connector Panel

Figure 4-18 shows the IMB-Q354 external peripheral interface connector (EPIC) panel.

The IMB-Q354 EPIC panel consists of the following:

- 3 x Audio jacks
- 1 x Parallel port
- 2 x PS/2 keyboard/mouse connectors
- 2 x RJ-45 LAN connectors
- 1 x Serial port connector
- 4 x USB 2.0 ports
- 1 x VGA connector

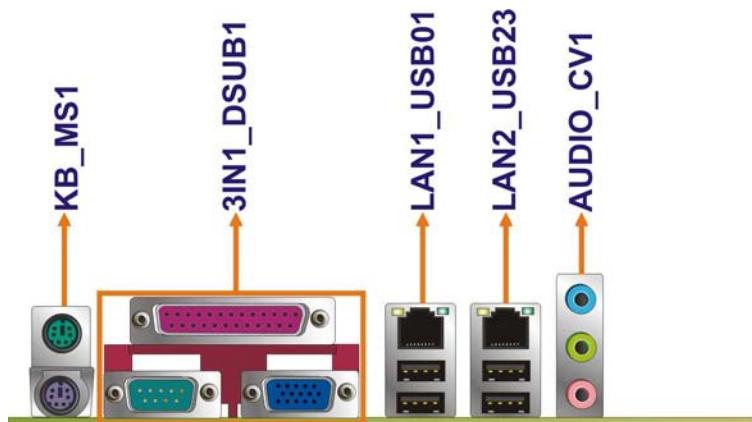

Figure 4-18: IMB-Q354 External Peripheral Interface Connector

4.3.1 Audio Connectors

- CN Label:** AUDIO_CV1
- CN Type:** 3 x audio jacks
- CN Location:** See **Figure 4-18**

The three audio jacks on the external audio connector enable the IMB-Q354 to be connected to external audio devices as specified below.

- **Line In port (Light Blue):** Connects a CD-ROM, DVD player, or other audio

devices.

- **Line Out port (Lime):** Connects to a headphone or a speaker. With multi-channel configurations, this port can also connect to front speakers.
- **Microphone (Pink):** Connects a microphone.

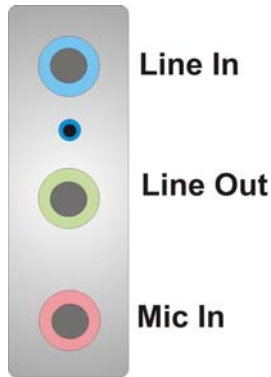

Figure 4-19: Audio Connector

4.3.2 Keyboard/Mouse Connector

- CN Label:** KB_MS1
- CN Type:** Dual PS/2
- CN Location:** See Figure 4-18
- CN Pinouts:** See Figure 4-20 and Table 4-19

The IMB-Q354 keyboard and mouse connectors are standard PS/2 connectors.

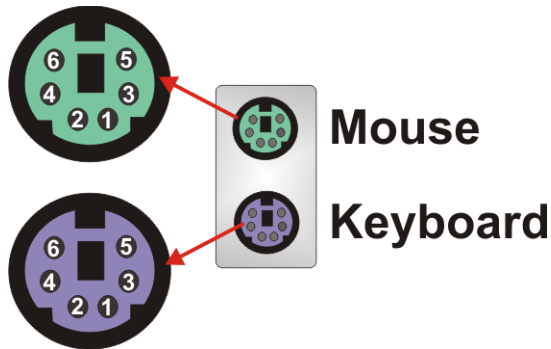

Figure 4-20: PS/2 Pinouts

PIN	DESCRIPTION
1	DATA
2	NC
3	GND
4	VCC5
5	CLK
6	NC

Table 4-19: PS/2 Connector Pinouts

4.3.3 LAN and Dual USB Combo Connectors

CN Label: LAN1_USB01 and LAN2_USB23

CN Type: RJ-45

CN Location: See **Figure 4-18**

CN Pinouts: See **Table 4-20**

The IMB-Q354 is equipped with two built-in RJ-45 Ethernet controllers. The controllers can connect to the LAN through two RJ-45 LAN connectors. There are two LEDs on the connector indicating the status of LAN. The pin assignments are listed in the following table:

PIN	DESCRIPTION	PIN	DESCRIPTION
1	MDIA3-	5	MDIA1+
2	MDIA3+	6	MDIA2+-
3.	MDIA2-	7	MDIA0-
4.	MDIA1-	8	MDIA0+

Table 4-20: LAN Pinouts

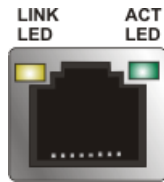

Figure 4-21: RJ-45 Ethernet Connector

The RJ-45 Ethernet connector has two status LEDs, one green and one yellow. The green LED indicates activity on the port and the yellow LED indicates the port is linked. See **Table 4-21**.

LINK LED		Activity LED	
Status	Description	Status	Description
Off	Not linked	Off	10 Mbps
Yellow	Linked	Green	100 Mbps
Blinking	Data activity	Orange	1 GbE

Table 4-21: RJ-45 Ethernet Connector LEDs

The IMB-Q354 has four external USB 2.0 ports. The ports are integrated into two dual USB and LAN combo connectors. The ports connect to both USB 2.0 and USB 1.1 devices.

PIN NO.	DESCRIPTION
1	VCC
2	DATA-
4	DATA+
4	GROUND

Table 4-22: USB Port Pinouts

4.3.4 Parallel Port, Serial Port and VGA Combo Connector

- CN Label:** 3IN1_DSUB1
- CN Type:** DB-25, DB-9 and DB-15
- CN Location:** See **Figure 4-18**
- CN Pinouts:** See **Table 4-23**, **Table 4-24** and **Table 4-25**

A 25-pin parallel port connector, a male DB-9 serial port (COM1) and a female DB-15 VGA connector are integrated into a single EPIC connector as shown in **Figure 4-18**.

The IMB-Q354 includes one on-board parallel port accessed through one 25-pin D-type female connector. The parallel port is usually connected to a printer. The connector is shown in **Figure 4-22** and the pinouts are shown in **Table 4-23**.

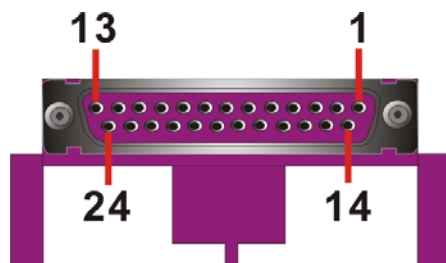

Figure 4-22 Parallel Port Connector Pinout Locations

PIN	Description	PIN	Description
1	STROBE#	2	DATA 0
3	DATA 1	4	DATA 2
5	DATA 3	6	DATA 4
7	DATA 5	8	DATA 6
9	DATA 7	10	ACKNOWLEDGE
11	BUSY	12	PAPER EMPTY
13	PRINTER SELECT	14	AUTO FORM FEED #
15	ERROR#	16	INITIALIZE

17	PRINTER SELECT LN#	18	GND
19	GND	20	GND
21	GND	22	GND
23	GND	24	GND
25	GND		

Table 4-23: Parallel Port Connector Pinouts

The male DB-9 COM 1 serial port connector is connected to RS-232 serial communications devices. The connector is shown in **Figure 4-23** and the pinouts are shown in **Table 4-24**.

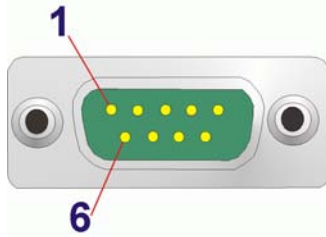
Figure 4-23: COM1 Pinout Locations

PIN NO.	DESCRIPTION	PIN NO.	DESCRIPTION
1	DCD	6	DSR
2	RX	7	RTS
3	TX	8	CTS
4	DTR	9	RI
5	GND		

Table 4-24: RS-232 Serial Port (COM 1) Pinouts

The female DB-15 VGA connector connects to standard VGA displays. The connector is shown in **Figure 4-24** and the pinouts are shown in **Table 4-25**.

IMB-Q354 uATX Motherboard

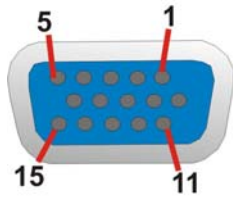

Figure 4-24: VGA Connector

PIN	DESCRIPTION	PIN	DESCRIPTION
1	RED	2	GREEN
3	BLUE	4	NC
5	GND	6	GND
7	GND	8	GND
9	VCC / NC	10	GND
11	NC	12	DDC DAT
13	HSYNC	14	VSYNC
15	DDCCLK		

Table 4-25: VGA Connector Pinouts

THIS PAGE IS INTENTIONALLY LEFT BLANK

Chapter

5

Installation

5.1 Anti-static Precautions



WARNING:

Failure to take ESD precautions during the installation of the IMB-Q354 may result in permanent damage to the IMB-Q354 and severe injury to the user.

Electrostatic discharge (ESD) can cause serious damage to electronic components, including the IMB-Q354. Dry climates are especially susceptible to ESD. It is therefore critical that whenever the IMB-Q354, or any other electrical component is handled, the following anti-static precautions are strictly adhered to.

- **Wear an anti-static wristband:** Wearing a simple anti-static wristband can help to prevent ESD from damaging the board.
- **Self-grounding:** Before handling the board touch any grounded conducting material. During the time the board is handled, frequently touch any conducting materials that are connected to the ground.
- **Use an anti-static pad:** When configuring the IMB-Q354, place it on an anti-static pad. This reduces the possibility of ESD damaging the IMB-Q354.
- **Only handle the edges of the PCB:** When handling the PCB, hold the PCB by the edges.

5.2 Installation Considerations



NOTE:

The following installation notices and installation considerations should be read and understood before the IMB-Q354 is installed. All installation notices pertaining to the installation of the IMB-Q354 should be strictly adhered to. Failing to adhere to these precautions may lead to severe damage of the IMB-Q354 and injury to the person installing the motherboard.

5.2.1 Installation Notices



WARNING:

The installation instructions described in this manual should be carefully followed in order to prevent damage to the IMB-Q354, IMB-Q354 components and injury to the user.

Before and during the installation please **DO** the following:

- Read the user manual:
 - The user manual provides a complete description of the IMB-Q354 installation instructions and configuration options.
- Wear an electrostatic discharge cuff (ESD):
 - Electronic components are easily damaged by ESD. Wearing an ESD cuff removes ESD from the body and helps prevent ESD damage.
- Place the IMB-Q354 on an antistatic pad:
 - When installing or configuring the motherboard, place it on an antistatic pad. This helps to prevent potential ESD damage.
- Turn all power to the IMB-Q354 off:

- When working with the IMB-Q354, make sure that it is disconnected from all power supplies and that no electricity is being fed into the system.

Before and during the installation of the IMB-Q354 **DO NOT**:

- Remove any of the stickers on the PCB board. These stickers are required for warranty validation.
- Use the product before verifying all the cables and power connectors are properly connected.
- Allow screws to come in contact with the PCB circuit, connector pins, or its components.

5.2.2 Installation Checklist

The following checklist is provided to ensure the IMB-Q354 is properly installed.

- All the items in the packing list are present
- The CPU is installed
- The CPU cooling kit is properly installed
- A compatible memory module is properly inserted into the slot
- The jumpers have been properly configured
- The IMB-Q354 is inserted into a chassis with adequate ventilation
- The correct power supply is being used
- The following devices are properly connected
 - SATA drives
 - Power supply
 - USB cable
 - Serial port cable
- The following external peripheral devices are properly connected to the chassis:
 - Keyboard/Mouse
 - VGA screen
 - USB devices
 - LAN

IMB-Q354 uATX Motherboard

5.3 Unpacking

5.3.1 Unpacking Precautions

When the IMB-Q354 is unpacked, please do the following:

- Follow the anti-static precautions outlined in **Section 5.1**.
- Make sure the packing box is facing upwards so the IMB-Q354 does not fall out of the box.
- Make sure all the components in the checklist shown in **Chapter 3** are present.



NOTE:

If some of the components listed in the checklist in **Chapter 3** are missing, please do not proceed with the installation. Contact the IEI reseller or vendor you purchased the IMB-Q354 from or contact an IEI sales representative directly. To contact an IEI sales representative, please send an email to sales@iei.com.tw.

5.4 CPU, CPU Cooling Kit and DIMM Installation



WARNING:

A CPU should never be turned on without the specified cooling kit being installed. If the cooling kit (heat sink and fan) is not properly installed and the system turned on, permanent damage to the CPU, IMB-Q354 and other electronic components attached to the system may be incurred. Running a CPU without a cooling kit may also result in injury to the user.

The CPU, CPU cooling kit and DIMM are the most critical components of the IMB-Q354. If one of these components is not installed the IMB-Q354 cannot run.

5.4.1 Socket LGA775 CPU Installation



NOTE:

Enabling Hyper-Threading Technology on your system requires meeting all of the platform requirements listed below:

- **CPU:** An Intel® Processor with HT Technology must be installed
- **Chipset:** An Intel® Chipset that supports HT Technology (that has been met by the IMB-Q354)
- **OS:** An operating system that has optimizations for HT Technology



WARNING:

CPUs are expensive and sensitive components. When installing the CPU please be careful not to damage it in anyway. Make sure the CPU is installed properly and ensure the correct cooling kit is properly installed.

The LGA775 socket is shown in **Figure 5-1**.

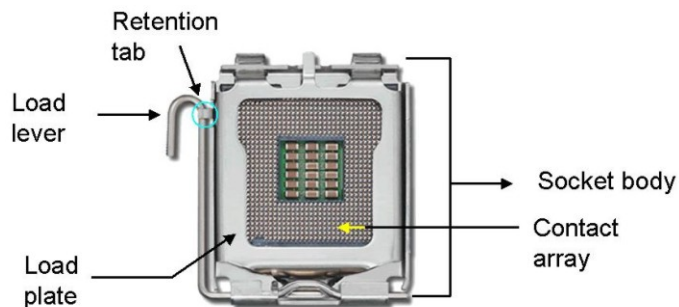

Figure 5-1: Intel® LGA775 Socket

IMB-Q354 uATX Motherboard

To install a socket LGA775 CPU onto the IMB-Q354, follow the steps below:



WARNING:

When handling the CPU, only hold it on the sides. DO NOT touch the pins at the bottom of the CPU.

Step 1: Remove the protective cover. Remove the black protective cover by prying it off the load plate. To remove the protective cover, locate the “REMOVE” sign and use your fingernail to pry the protective cover off. See **Figure 5-2**.

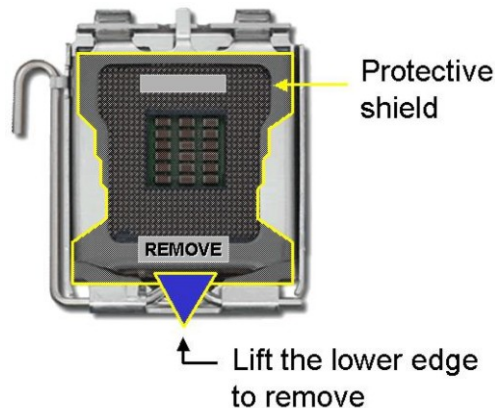

Figure 5-2: Remove the CPU Socket Protective Shield

Step 2: Open the socket. Disengage the load lever by pressing the lever down and slightly outward to clear the retention tab. Rotate the load lever to a fully open position. Then rotate the load plate towards the opposite direction.

See **Figure 5-3**.

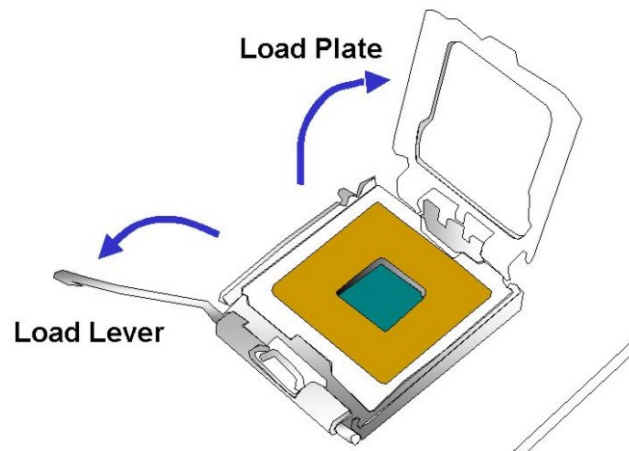

Figure 5-3: Open the CPU Socket Load Plate

- Step 3: Inspect the CPU socket** Make sure there are no bent pins and make sure the socket contacts are free of foreign material. If any debris is found, remove it with compressed air.
- Step 4: Orientate the CPU properly.** Make sure the IHS (Integrated Heat Sink) side is facing upward.
- Step 5: Correctly position the CPU.** Match the Pin 1 mark with the cut edge on the CPU socket.
- Step 6: Align the CPU pins.** Locate pin 1 and the two orientation notches on the CPU. Carefully match the two orientation notches on the CPU with the socket alignment keys.
- Step 7: Insert the CPU.** Gently insert the CPU into the socket. If the CPU pins are properly aligned, the CPU should slide into the CPU socket smoothly.
- See **Figure 5-4**.

IMB-Q354 uATX Motherboard

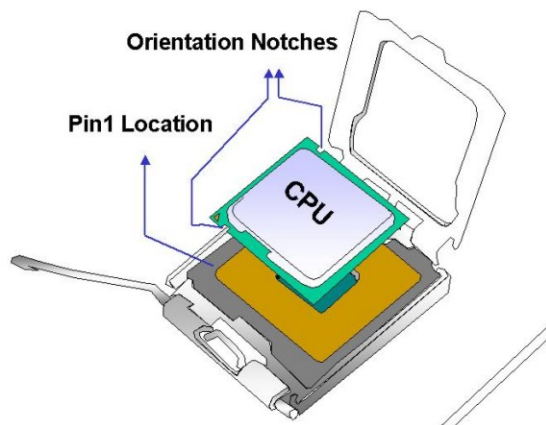

Figure 5-4: Insert the Socket LGA775 CPU

- Step 8: Close the CPU socket.** Close the load plate and engage the load lever by pushing it back to its original position. Secure the load lever under the retention tab on the side of CPU socket.
- Step 9: Connect the CPU 12V cable to the 12V power.** After the cooling kit is installed connect the CPU cable to the CPU 12V power connector.

5.4.2 Socket LGA775 CF-520 Cooling Kit Installation



WARNING:

It is strongly recommended that you **DO NOT** use the original heat sink and cooler provided by Intel® on the IMB-Q354.

IEI's cooling kit (CF-520) includes a support bracket that is combined with the heat sink mounted on the CPU to counterweigh and balance the load on both sides of the PCB.



Figure 5-5: IEI CF-520 Cooling Kit

An IEI Socket LGA775 CPU cooling kit shown in **Figure 5-5** can be purchased separately. The cooling kit comprises a CPU heat sink and a cooling fan.



WARNING:

Do not wipe off (accidentally or otherwise) the pre-sprayed layer of thermal paste on the bottom of the CF-520 heat sink. The thermal paste between the CPU and the heat sink is important for optimum heat dissipation.

To install the cooling kit, follow the instructions below.

- Step 1:** Place the cooling kit onto the socket LGA775 CPU. Make sure the CPU cable can be properly routed when the cooling kit is installed.
- Step 2:** Properly align the cooling kit. Make sure the four spring screw fasteners can pass through the pre-drilled holes on the PCB.
- Step 3:** Mount the cooling kit. Gently place the cooling kit on top of the CPU. Make sure the four threaded screws on the corners of the cooling kit properly pass through the predrilled holes on the bottom of the PCB.
- Step 4:** Secure the cooling kit. From the solder side of the PCB, align the support bracket to the screw threads on heat sink that were inserted through the PCB

IMB-Q354 uATX Motherboard

holes. (See **Figure 5-6**)

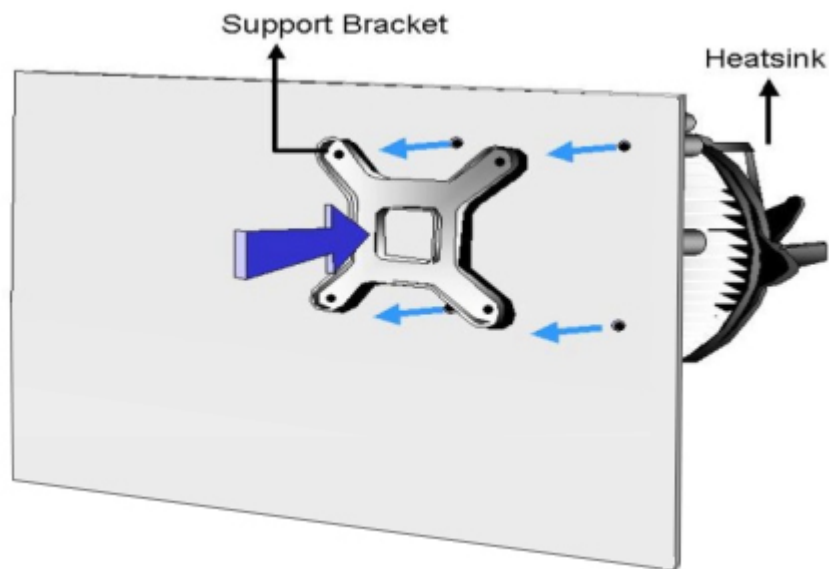

Figure 5-6: Securing the Heat sink to the PCB Board

- Step 5: Tighten the screws.** Use a screwdriver to tighten the four screws. Tighten each nut a few turns at a time and do not over-tighten the screws.
- Step 6: Connect the fan cable.** Connect the cooling kit fan cable to the fan connector on the IMB-Q354. Carefully route the cable and avoid heat generating chips and fan blades.

5.4.3 DIMM Installation



WARNING:

Using incorrectly specified DIMM may cause permanent damage to the IMB-Q354. Please make sure the purchased DIMM complies with the memory specifications of the IMB-Q354. DIMM specifications compliant with the IMB-Q354 are listed in **Chapter 2**.

5.4.3.1 DIMM Purchasing Guidelines



WARNING:

Only use DDR2 DIMMs. If DDR DIMMs are used the system may be irreparably damaged.

When purchasing the DDR2 DIMM, please follow the guidelines below:

- ONLY purchase DDR2 DIMM
- Have a frequency of 667 MHz or 800 MHz
- Have a maximum capacity of 2.0 GB
- If more than one DDR2 DIMM is being installed in the system, please purchase DIMM that have the same capacity and operating frequency.

5.4.3.2 DIMM Installation Order

There are two 64-bit wide DDR2 channels on the Intel® Q35 Northbridge, Channel A and Channel B. DDR2 Channel A and DDR2 Channel B are shown in **Figure 5-7** below.

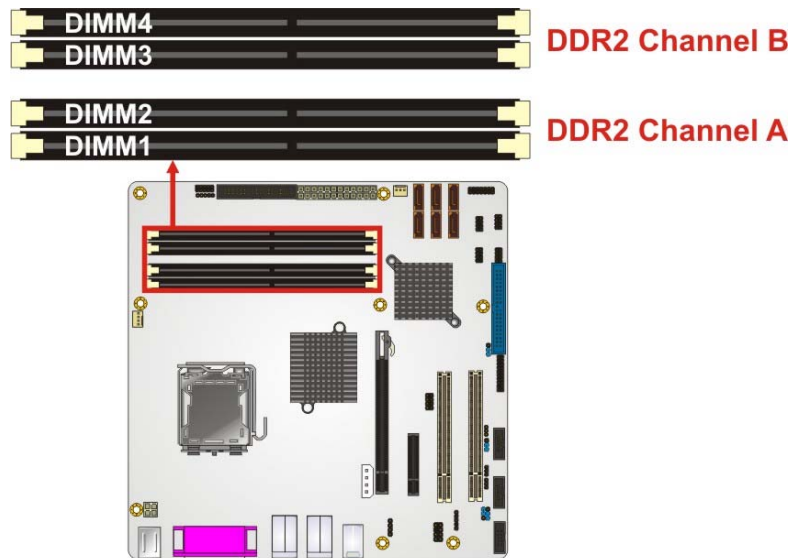

Figure 5-7: DDR2 Channels

IMB-Q354 uATX Motherboard

On the IMB-Q354, each channel is interfaced to two 240-pin DIMM sockets in the following order (see **Figure 5-7** above):

- **Channel A:** DIMM1 and DIMM2
- **Channel B:** DIMM3 and DIMM4

When populating the DDR2 DIMM sockets, populate them in the following order to optimize the memory performance:

Step 1: DIMM1. Install the first DDR2 DIMM into the DIMM1 DDR2 DIMM socket.

Step 2: DIMM3. Install the second DDR2 DIMM into the DIMM3 DDR2 DIMM socket.

Step 3: DIMM2. Install the third DDR2 DIMM into the DIMM2 DDR2 DIMM socket.

Step 4: DIMM4. Install the fourth DDR2 DIMM into the DIMM4 DDR2 DIMM socket.

5.4.3.3 DIMM Installation Guidelines

To install a DIMM into a DIMM socket, please follow the steps below and refer to **Figure 5-8**.

Step 1: Open the DIMM socket handles. The DIMM socket has two handles that secure the DIMM into the socket. Before the DIMM can be inserted into the socket, the handles must be opened. See **Figure 5-8**.

Step 2: Align the DIMM with the socket. The DIMM must be oriented in such a way that the notch in the middle of the DIMM must be aligned with the plastic bridge in the socket. See **Figure 5-8**.

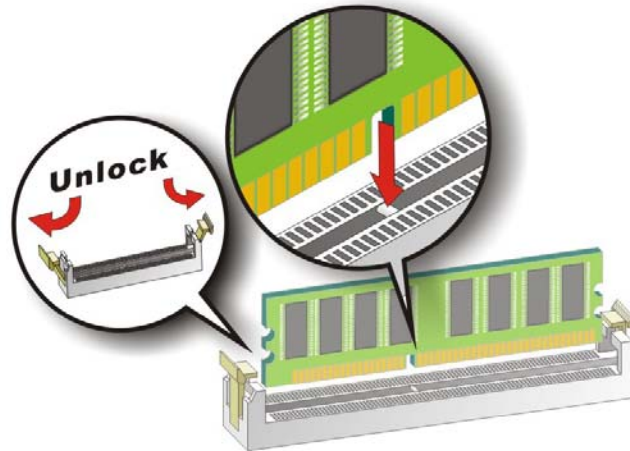

Figure 5-8: Installing a DIMM

Step 3: Insert the DIMM. Once properly aligned, the DIMM can be inserted into the socket. As the DIMM is inserted, the white handles on the side of the socket will close automatically and secure the DIMM to the socket. See **Figure 5-8**.

Step 4: Removing a DIMM. To remove a DIMM, push both handles outward. The memory module is ejected by a mechanism in the socket.

5.5 Jumper Settings



NOTE:

A jumper is a metal bridge that is used to close an electrical circuit. It consists of two metal pins and a small metal clip (often protected by a plastic cover) that slides over the pins to connect them. To CLOSE/SHORT a jumper means connecting the pins of the jumper with the plastic clip and to OPEN a jumper means removing the plastic clip from a jumper.

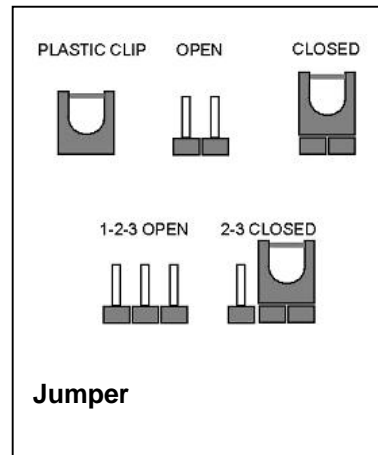

IMB-Q354 uATX Motherboard

Before the IMB-Q354 is installed in the system, the jumpers must be set in accordance with the desired configuration. The jumpers on the IMB-Q354 are listed in **Table 5-1**.

Description	Label	Type
Clear CMOS	J_CMOS1	3-pin header
COM2 pin 9 setting	J_COM_F2	3-pin header
COM3 pin 9 setting	J_COM_F3	3-pin header
COM4 pin 9 setting	J_COM_F4	3-pin header
COM2 pin 9 voltage setting	J_COM_V2	3-pin header
COM3 pin 9 voltage setting	J_COM_V3	3-pin header
COM4 pin 9 voltage setting	J_COM_V4	3-pin header

Table 5-1: Jumpers

5.5.1 Clear CMOS Jumper

- Jumper Label:** J_CMOS1
- Jumper Type:** 3-pin header
- Jumper Settings:** See **Table 5-2**
- Jumper Location:** See **Figure 5-9**

If the IMB-Q354 fails to boot due to improper BIOS settings, the clear CMOS jumper clears the CMOS data and resets the system BIOS information. To do this, use the jumper cap to close pins 2 and 3 for a few seconds then reinstall the jumper clip back to pins 1 and 2.

If the “CMOS Settings Wrong” message is displayed during the boot up process, the fault may be corrected by pressing the F1 to enter the CMOS Setup menu. Do one of the following:

- Enter the correct CMOS setting

- Load Optimal Defaults
- Load Failsafe Defaults.

After having done one of the above, save the changes and exit the CMOS Setup menu.

The clear CMOS jumper settings are shown in **Table 5-2**.

Clear CMOS	Description	
Short 1 - 2	Keep CMOS Setup	Default
Short 2 - 3	Clear CMOS Setup	

Table 5-2: Clear CMOS Jumper Settings

The location of the clear CMOS jumper is shown in **Figure 5-9** below.

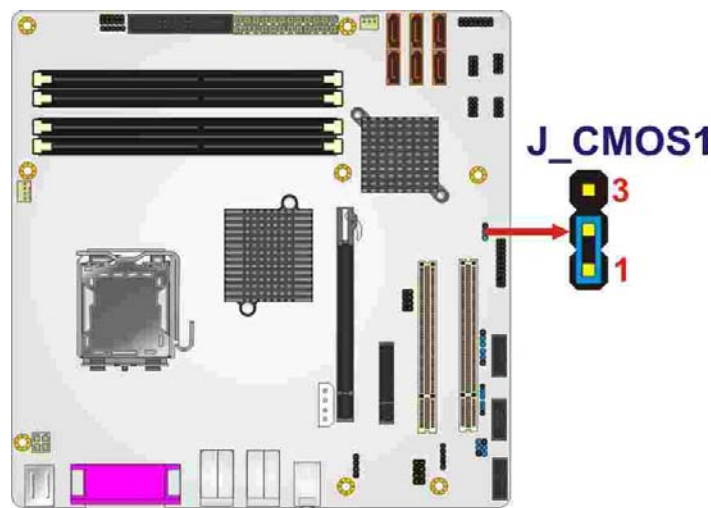

Figure 5-9: Clear CMOS Jumper

5.5.2 COM Port Pin 9 Setting Jumpers

Jumper Label: J_COM_F2, J_COM_F3 and J_COM_F4

Jumper Type: 3-pin header

Jumper Settings: See **Table 5-3**

Jumper Location: See **Figure 5-10**

IMB-Q354 uATX Motherboard

The COM Port Pin 9 Setting jumpers configure pin 9 on COM 2/COM 3/COM 4 as either a +5V, +12V power source (see **Section 5.5.3** to setup) or as a ring-in (RI) line. The COM Port Pin 9 Setting jumpers selection options are shown in **Table 5-3**.

J_COM_F2	Description	
Short 1 – 2	COM 2 RI Pin use voltage	
Short 2 – 3	COM 2 RI Pin use RI	Default
J_COM_F3	Description	
Short 1 – 2	COM 3 RI Pin use voltage	
Short 2 – 3	COM 3 RI Pin use RI	Default
J_COM_F4	Description	
Short 1 – 2	COM 4 RI Pin use voltage	
Short 2 – 3	COM 4 RI Pin use RI	Default

Table 5-3: COM Port Pin 9 Setting Jumper Settings

The COM Port Pin 9 Setting jumper locations are shown in **Figure 5-10** below.

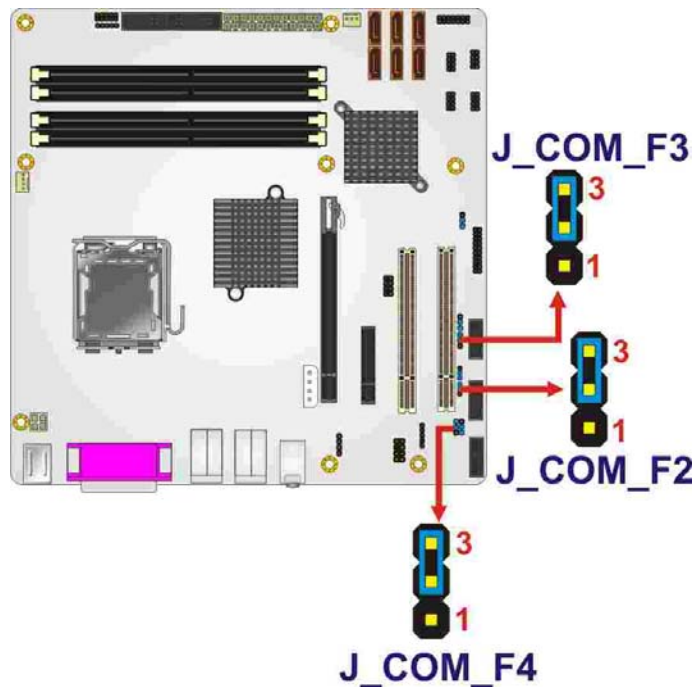

Figure 5-10: COM Port Pin 9 Setting Jumper Locations

5.5.3 COM Port Pin 9 Voltage Setting Jumpers

Jumper Label: J_COM_V2, J_COM_V3 and J_COM_V4

Jumper Type: 3-pin header

Jumper Settings: See Table 5-3

Jumper Location: See Figure 5-10

The COM Port Pin 9 Voltage Setting jumpers configure pin 9 on COM 2/COM 3/COM 4 as either a +5V or +12V power source. The COM Port Pin 9 Voltage Setting jumpers selection options are shown in **Table 5-3**.

J_COM_V2	Description	
Short 1 – 2	COM 2 RI Pin use +5V	Default
Short 2 – 3	COM 2 RI Pin use +12V	
J_COM_V3	Description	
Short 1 – 2	COM 3 RI Pin use +5V	Default
Short 2 – 3	COM 3 RI Pin use +12V	
J_COM_V4	Description	
Short 1 – 2	COM 4 RI Pin use +5V	Default
Short 2 – 3	COM 4 RI Pin use +12V	

Table 5-4: COM Port Pin 9 Voltage Setting Jumper Settings

The COM Port Pin 9 Voltage Setting jumper locations are shown in **Figure 5-10** below.

IMB-Q354 uATX Motherboard

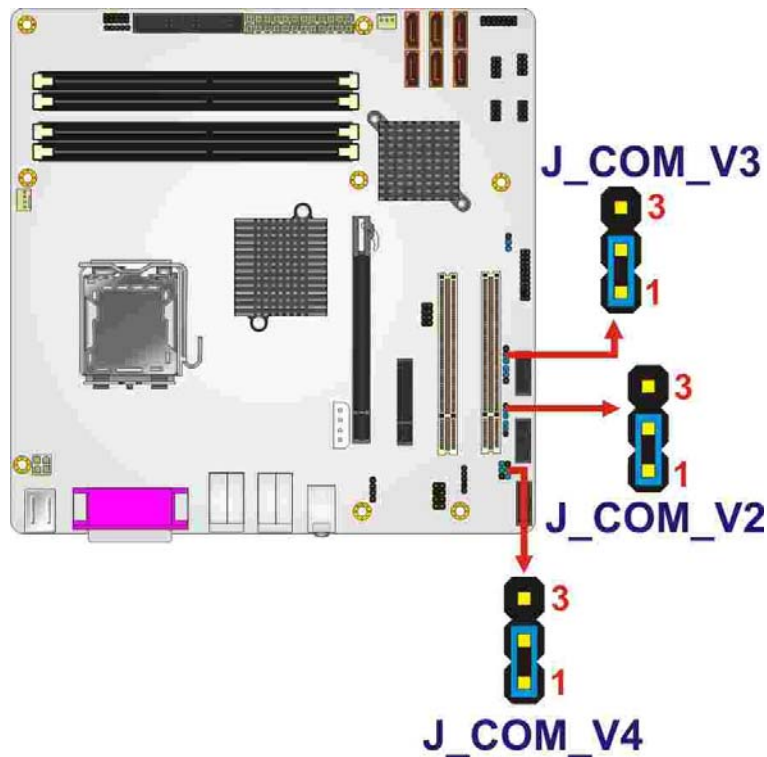

Figure 5-11: COM Port Pin 9 Voltage Setting Jumper Locations

5.6 Chassis Installation

5.6.1 Airflow

**WARNING:**

Airflow is critical to the cooling of the CPU and other onboard components. The chassis in which the IMB-Q354 must have air vents to allow cool air to move into the system and hot air to move out.

The IMB-Q354 must be installed in a chassis with ventilation holes on the sides allowing airflow to travel through the heat sink surface. In a system with an individual power supply unit, the cooling fan of a power supply can also help generate airflow through the board surface.

5.6.2 Motherboard Installation

To install the IMB-Q354 motherboard into the chassis please refer to the reference material that came with the chassis.

5.7 Internal Peripheral Device Connections

5.7.1 Peripheral Device Cables

The cables listed in **Table 5-5** are shipped with the IMB-Q354.

Quantity	Type
1	Dual RS-232 cable
6	SATA drive cables
3	SATA drive power cables
1	USB cable

Table 5-5: IEI Provided Cables

Separately purchased optional IEI items that can be installed are listed below:

- TPM Module

For more details about the items listed above, please refer to **Chapter 3**. Installation of the accessories listed above are described in detail below.

5.7.2 Dual RS-232 Cable Connection

The dual RS-232 cable consists of two connectors attached to two independent cables. Each cable is then attached to a D-sub 9 male connector that is mounted onto a bracket. To install the dual RS-232 cable, please follow the steps below.

Step 1: Locate the connectors. The locations of the RS-232 connectors are shown in **Chapter 3**.

Step 2: Insert the cable connectors. Insert one connector into each serial port box

IMB-Q354 uATX Motherboard

headers. See **Figure 5-12**. A key on the front of the cable connectors ensures the connector can only be installed in one direction.

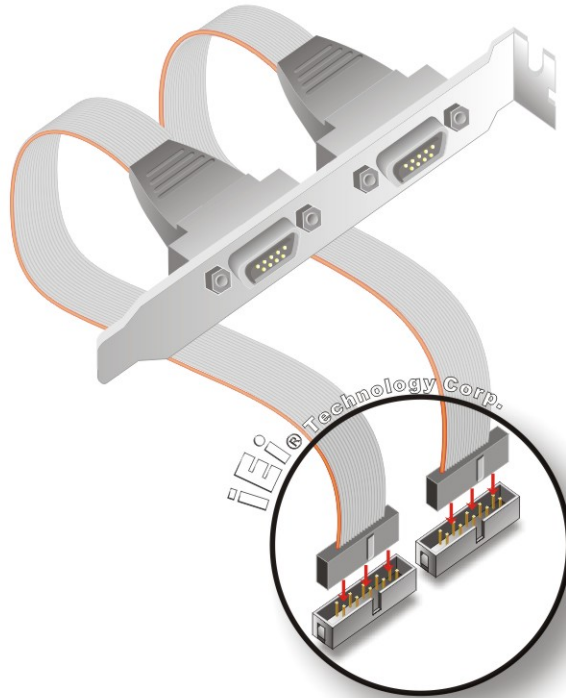

Figure 5-12: Dual RS-232 Cable Installation

Step 3: Secure the bracket. The dual RS-232 connector has two D-sub 9 male connectors secured on a bracket. To secure the bracket to the chassis please refer to the reference material that came with the chassis

5.7.3 SATA Drive Connection

The IMB-Q354 is shipped with two SATA drive cables and one SATA drive power cable. To connect the SATA drives to the connectors, please follow the steps below.

Step 1: Locate the connectors. The locations of the SATA drive connectors are shown in **Chapter 3**.

Step 2: Insert the cable connector. Press the clip on the connector at the end of the SATA cable and insert the cable connector into the onboard SATA drive

connector. See **Figure 5-13**.

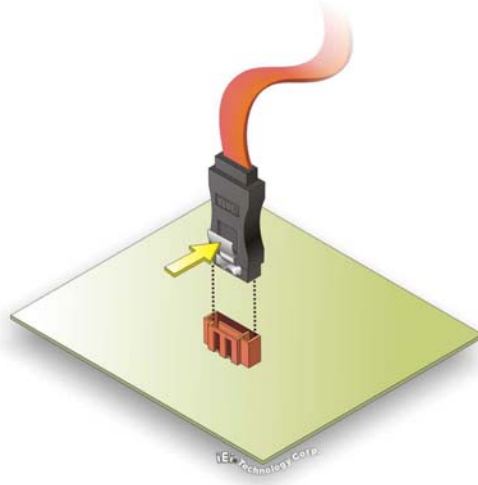

Figure 5-13: SATA Drive Cable Connection

Step 3: **Connect the cable to the SATA disk.** Connect the connector on the other end of the cable to the connector at the back of the SATA drive. See **Figure 5-14**.

Step 4: **Connect the SATA power cable.** Connect the SATA power connector to the back of the SATA drive. See **Figure 5-14**.

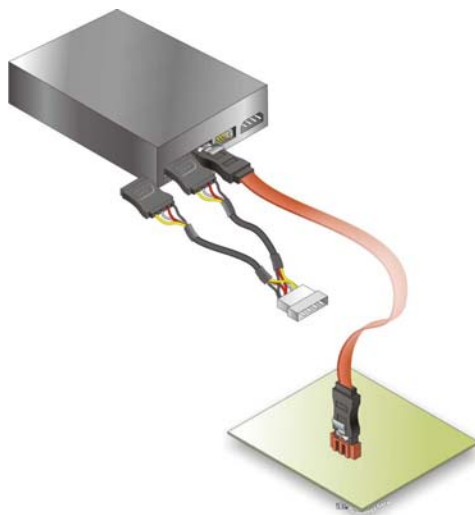

Figure 5-14: SATA Power Drive Connection

IMB-Q354 uATX Motherboard

5.7.4 USB Cable (Dual Port)

The IMB-Q354 is shipped with a dual port USB 2.0 cable. To connect the USB cable connector, please follow the steps below.

Step 1: Locate the connectors. The locations of the USB connectors are shown in Chapter 3.



WARNING:

If the USB pins are not properly aligned, the USB device can burn out.

Step 2: Align the connectors. The cable has two connectors. Correctly align pin 1 on each cable connector with pin 1 on the IMB-Q354 USB connector.

Step 3: Insert the cable connectors. Once the cable connectors are properly aligned with the USB connectors on the IMB-Q354, connect the cable connectors to the onboard connectors. See **Figure 5-15**.

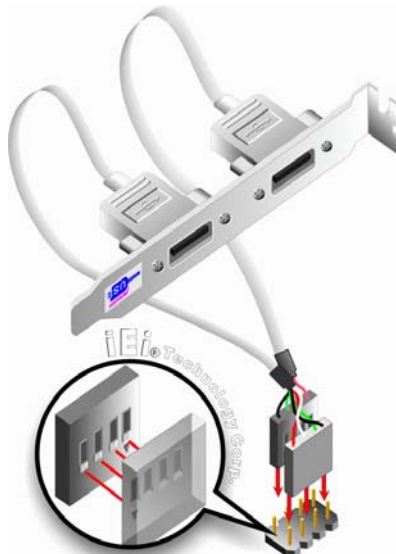

Figure 5-15: Dual USB Cable Connection

Step 4: Attach the bracket to the chassis. The USB 2.0 connectors are attached to a

bracket. To secure the bracket to the chassis please refer to the installation instructions that came with the chassis.

5.7.5 PCIe x16 Expansion Card Installation

A PCIe x16 expansion card can be installed on the IMB-Q354 using the PCIe x16 expansion slot. To install a PCIe expansion card into the PCIe socket, please follow the steps below and refer to **Figure 5-16**.

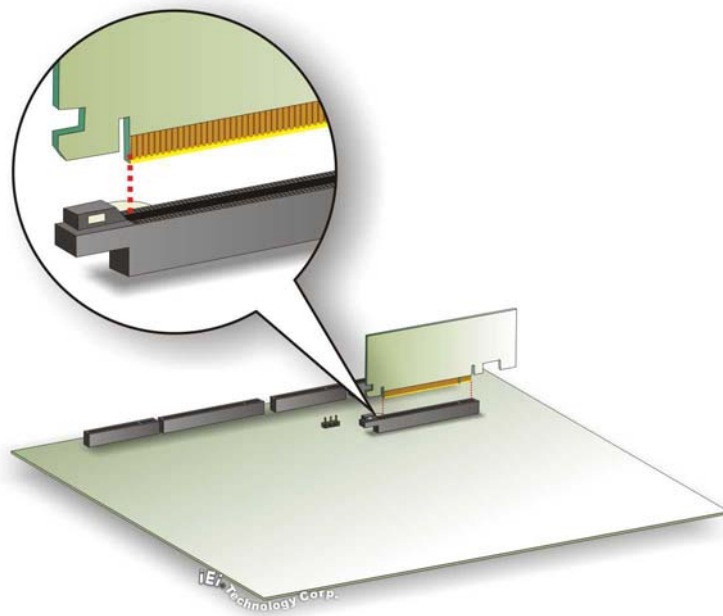

Figure 5-16: PCIe x16 Installation

- Step 1:** **Locate the PCIe x16 socket.** Place the IMB-Q354 on an anti-static pad with the solder side facing up.
- Step 2:** **Align the PCIe x16 card with the socket.** The PCIe x16 card must be aligned so the notch on the PCIe x16 card aligns with the plastic bridge in the socket.
- Step 3:** **Insert the PCIe x16 card.** Push the PCIe x16 card into the socket, perpendicular to the IMB-Q354.
- Step 4:** **Secure the PCI x16 card.** Push the PCIe x16 card down until the clip engages,

securing the card in place.

5.8 External Peripheral Interface Connection

The following external peripheral devices can be connected to the external peripheral interface connectors.

- Audio devices
- RJ-45 Ethernet cable connectors
- Parallel port device
- Keyboard/mouse
- Serial port devices
- USB devices
- VGA monitors

To install these devices, connect the corresponding cable connector from the actual device to the corresponding IMB-Q354 external peripheral interface connector making sure the pins are properly aligned.

5.8.1 Audio Connection

Audio signals are interfaced through three phone jack connections. The red phone jack is for Mic In, blue is for Line In and green is for Speaker Out. Follow the steps below to connect audio devices to the IMB-Q354.

Step 1: Locate the audio phone jacks. The locations of the audio phone jacks are shown in **Chapter 3**.

Step 2: Insert audio phone jack plugs. Insert audio phone jack plugs into the audio phone jacks on the external peripheral interface. See **Figure 5-17**.

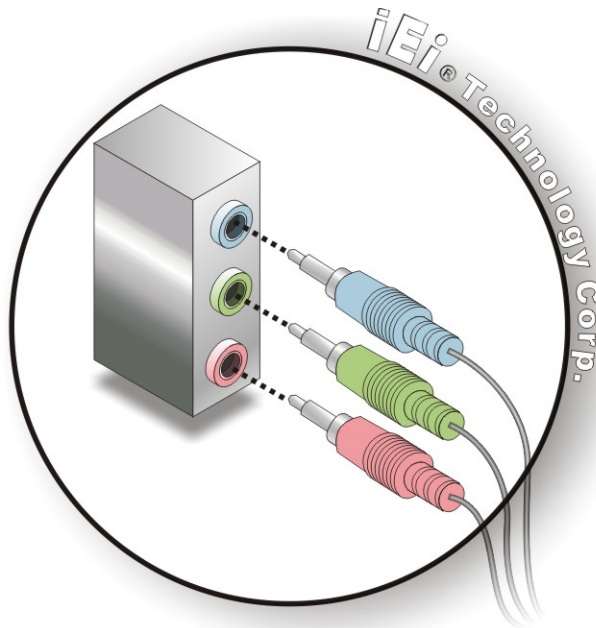

Figure 5-17: Audio Connectors

5.8.2 LAN Connection (Single Connector)

There are two external RJ-45 LAN connectors. The RJ-45 connectors enable connection to an external network. To connect a LAN cable with an RJ-45 connector, please follow the instructions below.

Step 1: Locate the RJ-45 connectors. The locations of the USB connectors are shown in **Chapter 4**.

Step 2: Align the connectors. Align the RJ-45 connector on the LAN cable with one of the RJ-45 connectors on the IMB-Q354. See **Figure 5-18**.

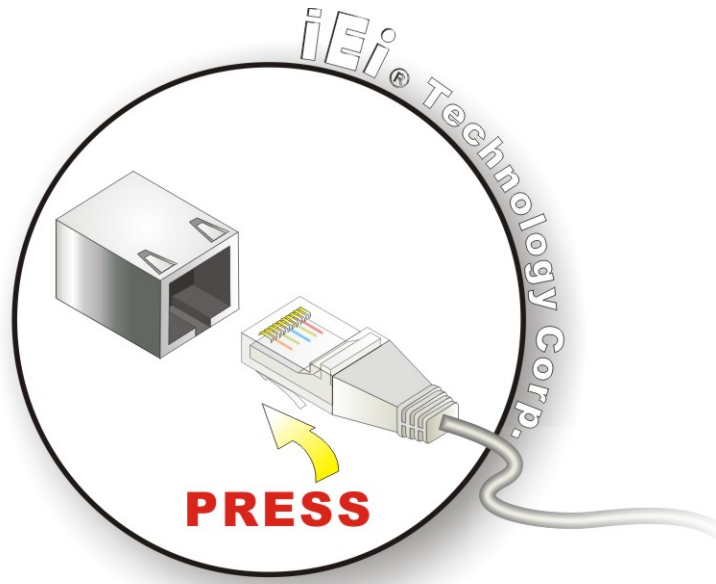

Figure 5-18: LAN Connection

Step 3: Insert the LAN cable RJ-45 connector. Once aligned, gently insert the LAN cable RJ-45 connector into the onboard RJ-45 connector.

5.8.3 Parallel Device Connection

The IMB-Q354 has a single female DB-25 connector on the external peripheral interface panel for parallel devices. Follow the steps below to connect a parallel device to the IMB-Q354.

Step 1: Locate the DB-25 connector. The location of the DB-25 connector is shown in Chapter 3.

Step 2: Insert the DB-25 connector. Insert the DB-25 connector of a parallel device into the DB-25 connector on the external peripheral interface. See **Figure 5-19**.

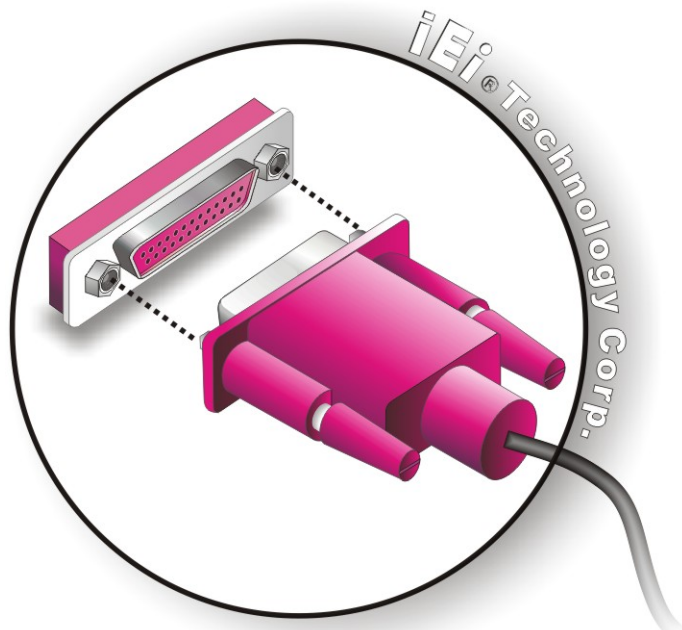

Figure 5-19: Parallel Device Connector

Step 3: **Secure the connector.** Secure the DB-25 connector to the external interface by tightening the two retention screws on either side of the connector.

5.8.4 PS/2 Keyboard and Mouse Connection

The IMB-Q354 has a dual PS/2 connector on the external peripheral interface panel. The dual PS/2 connector is used to connect to a keyboard and mouse to the system. Follow the steps below to connect a keyboard and mouse to the IMB-Q354.

Step 1: **Locate the dual PS/2 connector.** The location of the dual PS/2 connector is shown in **Chapter 3**.

Step 2: **Insert the keyboard/mouse connector.** Insert a PS/2 keyboard or mouse connector into the appropriate PS/2 connector on the external peripheral interface connector. See **Figure 5-20**.

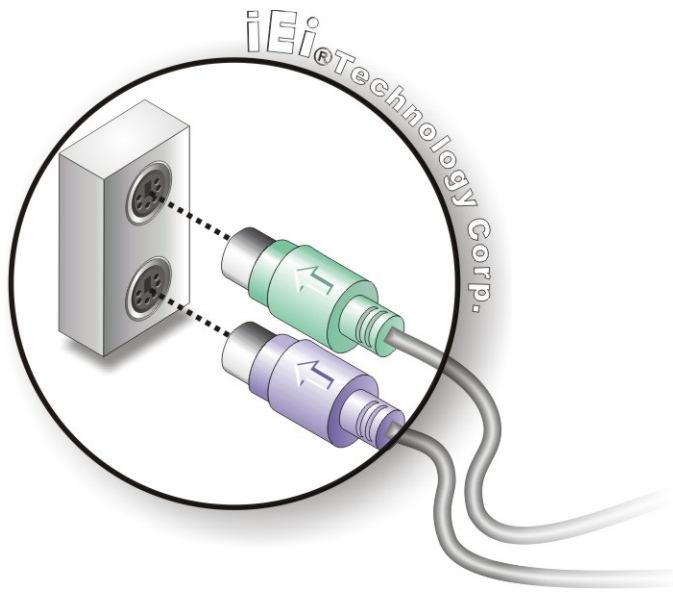

Figure 5-20: PS/2 Keyboard/Mouse Connector

5.8.5 Serial Device Connection

The IMB-Q354 has a single male DB-9 connector on the external peripheral interface panel for a serial device. Follow the steps below to connect a serial device to the IMB-Q354.

Step 1: Locate the DB-9 connector. The location of the DB-9 connector is shown in Chapter 3.

Step 2: Insert the serial connector. Insert the DB-9 connector of a serial device into the DB-9 connector on the external peripheral interface. See Figure 5-21.

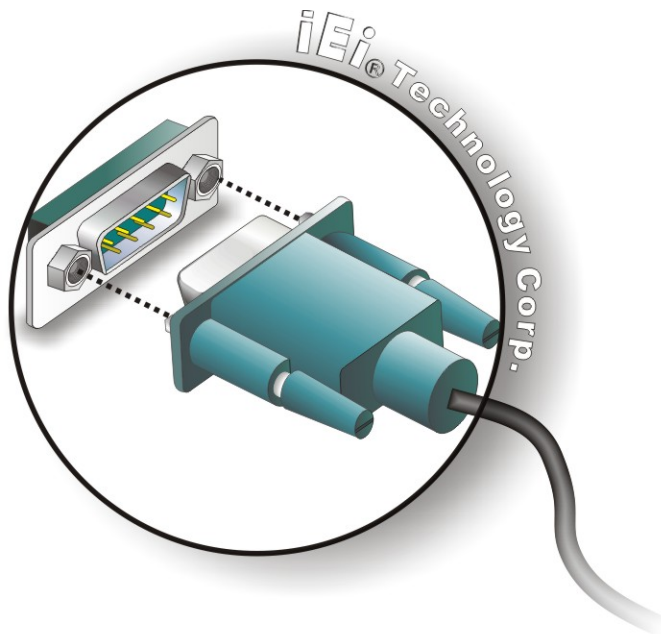

Figure 5-21: Serial Device Connector

Step 3: Secure the connector. Secure the serial device connector to the external interface by tightening the two retention screws on either side of the connector.

5.8.6 USB Device Connection

There are two external USB 2.0 connectors. Both connectors are perpendicular to the IMB-Q354. To connect a USB 2.0 or USB 1.1 device, please follow the instructions below.

Step 1: Located the USB connectors. The locations of the USB connectors are shown in **Chapter 4**.

Step 2: Align the connectors. Align the USB device connector with one of the connectors on the IMB-Q354. See **Figure 5-22**.

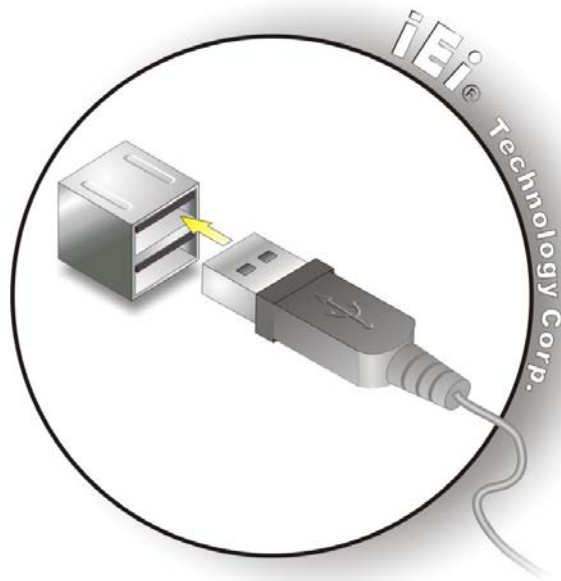

Figure 5-22: USB Device Connection

Step 3: **Insert the device connector.** Once aligned, gently insert the USB device connector into the onboard connector.

5.8.7 VGA Monitor Connection

The IMB-Q354 has a single female DB-15 connector on the external peripheral interface panel. The DB-15 connector is connected to a CRT or VGA monitor. To connect a monitor to the IMB-Q354, please follow the instructions below.

- Step 1:** **Locate the female DB-15 connector.** The location of the female DB-15 connector is shown in **Chapter 3**.
- Step 2:** **Align the VGA connector.** Align the male DB-15 connector on the VGA screen cable with the female DB-15 connector on the external peripheral interface.
- Step 3:** **Insert the VGA connector** Once the connectors are properly aligned with the insert the male connector from the VGA screen into the female connector on the IMB-Q354. See **Figure 5-23**.

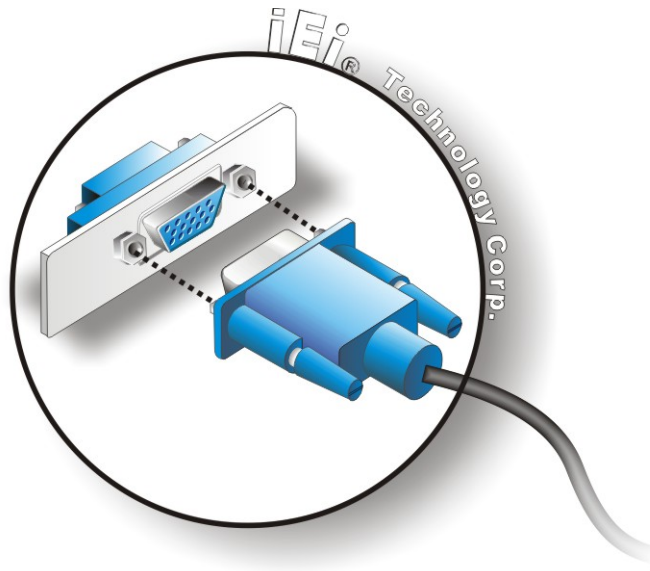

Figure 5-23: VGA Connector

Step 4: Secure the connector. Secure the DB-15 VGA connector from the VGA monitor to the external interface by tightening the two retention screws on either side of the connector.

Chapter

6

AMI BIOS

6.1 Introduction

A licensed copy of AMI BIOS is preprogrammed into the ROM BIOS. The BIOS setup program allows users to modify the basic system configuration. This chapter describes how to access the BIOS setup program and the configuration options that may be changed.

6.1.1 Starting Setup

The AMI BIOS is activated when the computer is turned on. The setup program can be activated in one of two ways.

1. Press the **DELETE** key as soon as the system is turned on or
2. Press the **DELETE** key when the “**Press Del to enter SETUP**” message appears on the screen.

If the message disappears before the **DELETE** key is pressed, restart the computer and try again.

6.1.2 Using Setup

Use the arrow keys to highlight items, press **ENTER** to select, use the PageUp and PageDown keys to change entries, press **F1** for help and press **ESC** to quit. Navigation keys are shown in.

Key	Function
Up arrow	Move to previous item
Down arrow	Move to next item
Left arrow	Move to the item on the left hand side
Right arrow	Move to the item on the right hand side
Esc key	Main Menu – Quit and not save changes into CMOS Status Page Setup Menu and Option Page Setup Menu -- Exit current page and return to Main Menu
Page Up key	Increase the numeric value or make changes
Page Dn key	Decrease the numeric value or make changes

IMB-Q354 uATX Motherboard

F1 key	General help, only for Status Page Setup Menu and Option Page Setup Menu
F2 /F3 key	Change color from total 16 colors. F2 to select color forward.
F10 key	Save all the CMOS changes, only for Main Menu

Table 6-1: BIOS Navigation Keys

6.1.3 Getting Help

When **F1** is pressed a small help window describing the appropriate keys to use and the possible selections for the highlighted item appears. To exit the Help Window press **Esc** or the **F1** key again.

6.1.4 Unable to Reboot After Configuration Changes

If the computer cannot boot after changes to the system configuration is made, CMOS defaults. Use the jumper described in **Chapter 5.5.1**.

6.1.5 BIOS Menu Bar

The **menu bar** on top of the BIOS screen has the following main items:

- **Main** Changes the basic system configuration.
- **Advanced** Changes the advanced system settings.
- **PCIPnP** Changes the advanced PCI/PnP Settings
- **Boot** Changes the system boot configuration.
- **Security** Sets User and Supervisor Passwords.
- **Chipset** Changes the chipset settings.
- **Exit** Selects exit options and loads default settings

The following sections completely describe the configuration options found in the menu items at the top of the BIOS screen and listed above.

6.2 Main

The **Main** BIOS menu (**BIOS Menu 1**) appears when the **BIOS Setup** program is entered.

The **Main** menu gives an overview of the basic system information.

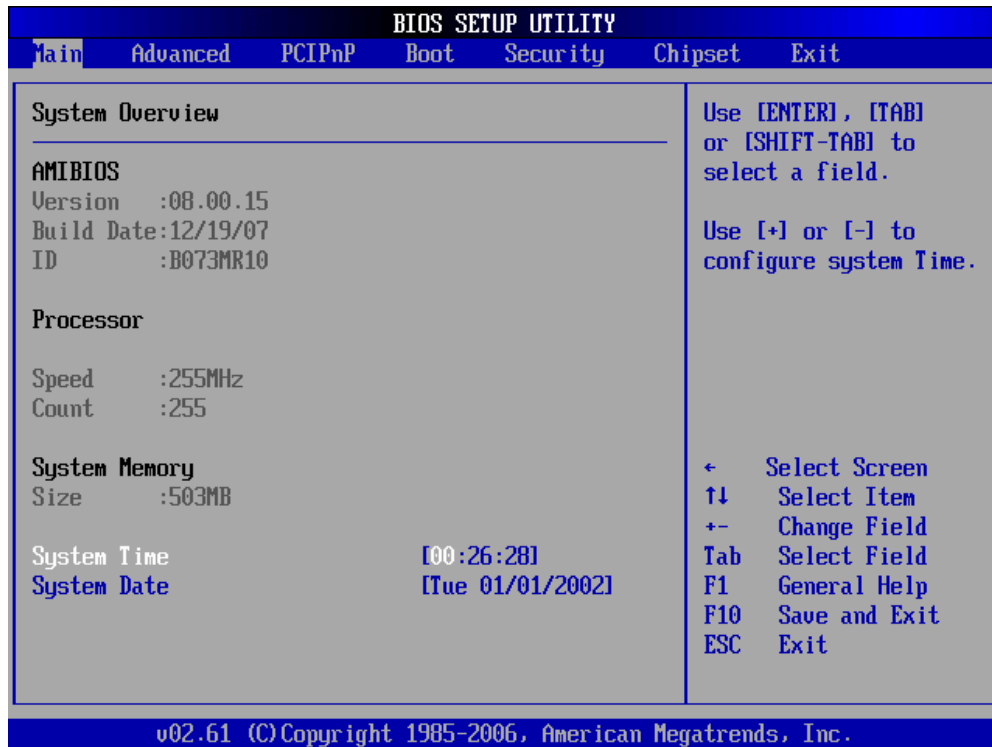

BIOS Menu 1: Main

→ System Overview

The **System Overview** lists a brief summary of different system components. The fields in

System Overview cannot be changed. The items shown in the system overview include:

- AMI BIOS: Displays auto-detected BIOS information
 - **Version:** Current BIOS version
 - **Build Date:** Date the current BIOS version was made
 - **ID:** Installed BIOS ID
- Processor: Displays auto-detected CPU specifications
 - **Type:** Names the currently installed processor
 - **Speed:** Lists the processor speed

IMB-Q354 uATX Motherboard

- **Count:** The number of CPUs on the motherboard
- System Memory: Displays the auto-detected system memory.
- **Size:** Lists memory size

The System Overview field also has two user configurable fields:

→ System Time [xx:xx:xx]

Use the **System Time** option to set the system time. Manually enter the hours, minutes and seconds.

→ System Date [xx/xx/xx]

Use the **System Date** option to set the system date. Manually enter the day, month and year.

6.3 Advanced

Use the **Advanced** menu (**BIOS Menu 2**) to configure the CPU and peripheral devices through the following sub-menus:



WARNING!

Setting the wrong values in the sections below may cause the system to malfunction. Make sure that the settings made are compatible with the hardware.

-
- CPU Configuration (see **Section 6.3.1**)
 - IDE Configuration (see **Section 6.3.2**)
 - Floppy Configuration (see **Section 6.3.3**)
 - Super IO Configuration (see **Section 6.3.4**)
 - Hardware Health Configuration (see **Section 6.3.5**)
 - ACPI Configuration (see **Section 6.3.6**)
 - AHCI Configuration (see **Section 6.3.7**)
 - Intel AMT Configuration (see **Section 6.3.8**)
 - Remote Access Configuration (see **Section 6.3.9**)

- Trusted Computing (see **Section 6.3.10**)
- USB Configuration (see **Section 6.3.11**)



BIOS Menu 2: Advanced

6.3.1 CPU Configuration

Use the **CPU Configuration** menu (**BIOS Menu 3**) to view detailed CPU specifications and configure the CPU.

IMB-Q354 uATX Motherboard

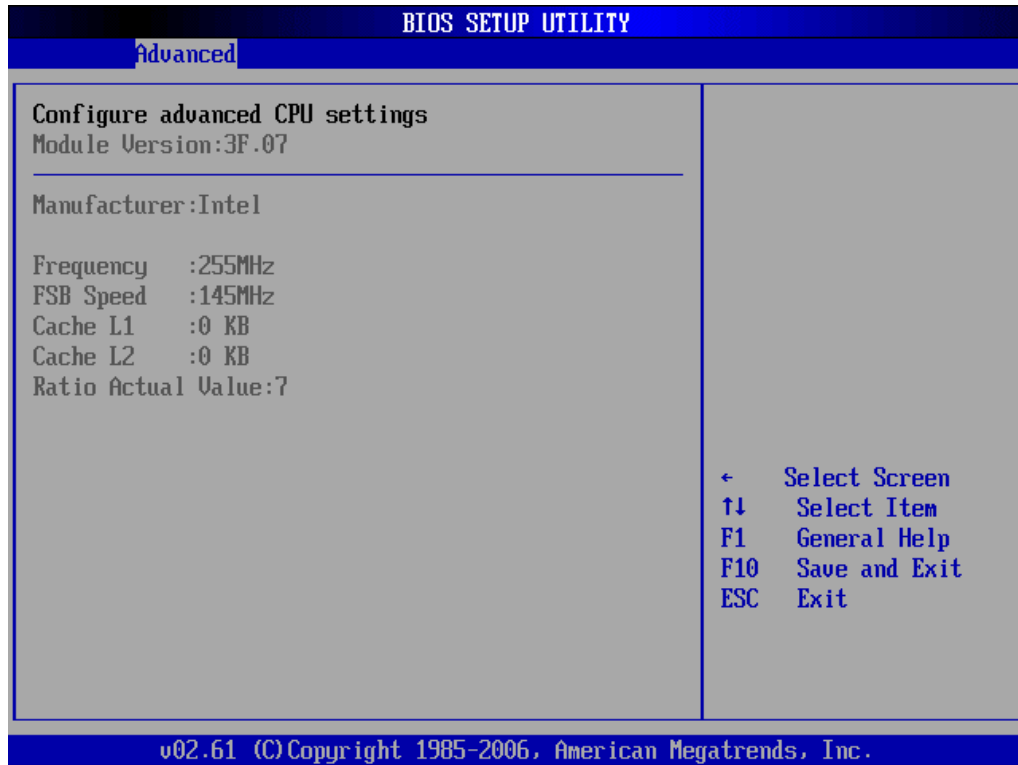
**BIOS Menu 3: CPU Configuration**

The CPU Configuration menu (**BIOS Menu 3**) lists the following CPU details:

- Manufacturer: Lists the name of the CPU manufacturer
- Brand String: Lists the brand name of the CPU being used
- Frequency: Lists the CPU processing speed
- FSB Speed: Lists the FSB speed
- Cache L1: Lists the CPU L1 cache size
- Cache L2: Lists the CPU L2 cache size

6.3.2 IDE Configuration

Use the **IDE Configuration** menu (**BIOS Menu 4**) to change and/or set the configuration of the IDE devices installed in the system.

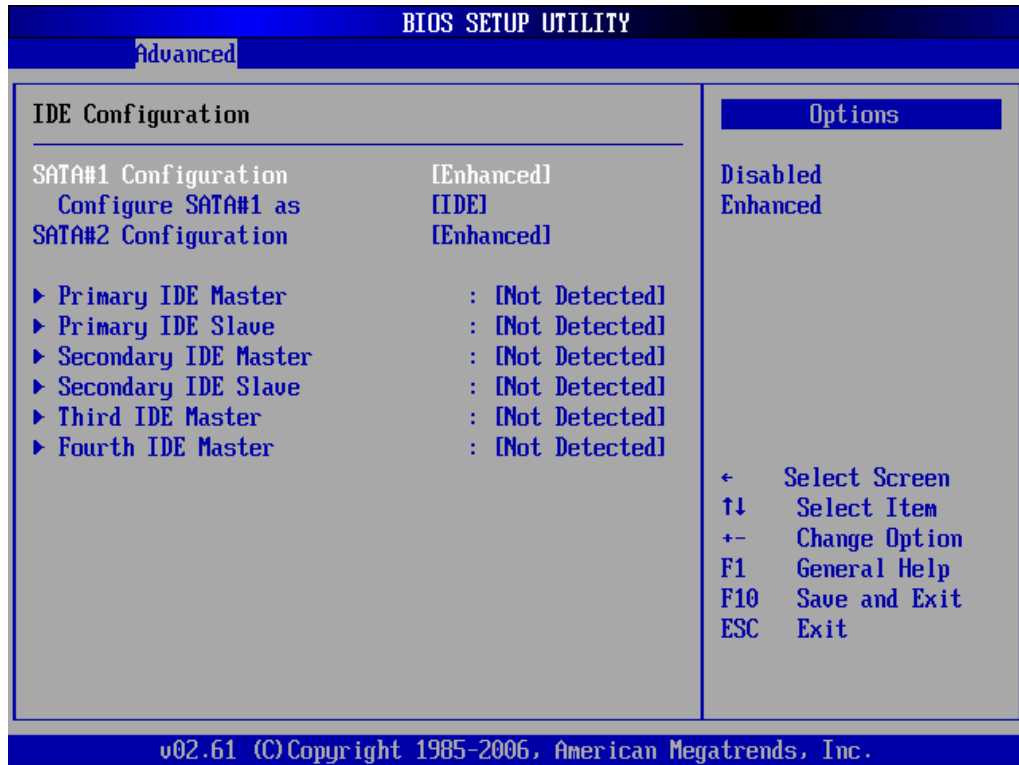

BIOS Menu 4: IDE Configuration

→ SATA#1 Configuration [Enhanced]

Use the **SATA#n** BIOS option to enable the nth SATA drive port.

- **Disabled** The nth SATA drive port is disabled
- **Enhanced** **DEFAULT** The nth SATA drive port is activated

→ Configure SATA as [IDE]

Use the **Configure SATA as** option to configure SATA devices as normal IDE devices.

- **IDE** **DEFAULT** Configures SATA devices as normal IDE device.
- **RAID** Configures SATA devices as RAID device.
- **AHCI** Configures SATA devices as AHCI device.

IMB-Q354 uATX Motherboard

→ IDE Master and IDE Slave

When entering setup, BIOS auto detects the presence of IDE devices. BIOS displays the status of the auto detected IDE devices. The following IDE devices are detected and are shown in the **IDE Configuration** menu:

- Primary IDE Master
- Primary IDE Slave
- Secondary IDE Master
- Secondary IDE Slave
- Third IDE Master
- Fourth IDE Master

The **IDE Configuration** menu (**BIOS Menu 4**) allows changes to the configurations for the IDE devices installed in the system. If an IDE device is detected, and one of the above listed four BIOS configuration options are selected, the IDE configuration options shown in **Section 6.3.2.1** appear.

6.3.2.1 IDE Master, IDE Slave

Use the **IDE Master** and **IDE Slave** configuration menu to view both primary and secondary IDE device details and configure the IDE devices connected to the system.

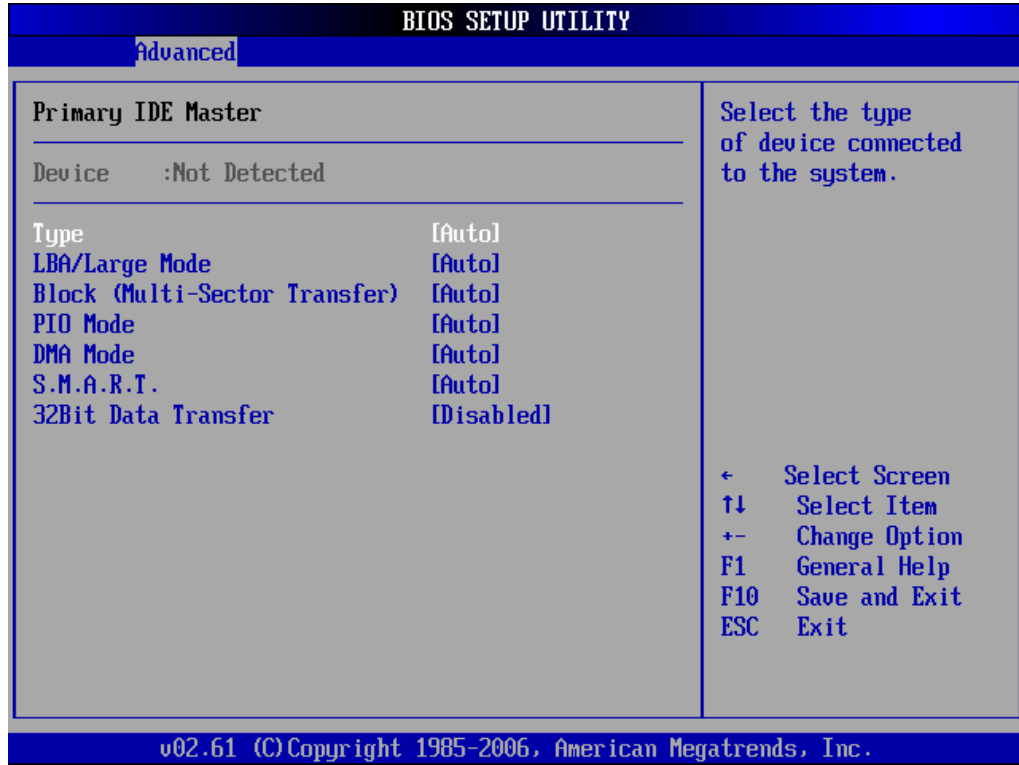

BIOS Menu 5: IDE Master and IDE Slave Configuration

➔ **Auto-Detected Drive Parameters**

The “grayed-out” items in the left frame are IDE disk drive parameters automatically detected from the firmware of the selected IDE disk drive. The drive parameters are listed as follows:

- Device: Lists the device type (e.g. hard disk, CD-ROM etc.)
- Type: Indicates the type of devices a user can manually select
- Vendor: Lists the device manufacturer
- Size: List the storage capacity of the device.
- LBA Mode: Indicates whether the LBA (Logical Block Addressing) is a method of addressing data on a disk drive is supported or not.
- Block Mode: Block mode boosts IDE drive performance by increasing the amount of data transferred. Only 512 bytes of data can be transferred per interrupt if block mode is not used. Block mode allows transfers of up to 64 KB per interrupt.
- PIO Mode: Indicates the PIO mode of the installed device.

IMB-Q354 uATX Motherboard

- Async DMA: Indicates the highest Asynchronous DMA Mode that is supported.
- Ultra DMA: Indicates the highest Synchronous DMA Mode that is supported.
- S.M.A.R.T.: Indicates whether or not the Self-Monitoring Analysis and Reporting Technology protocol is supported.
- 32Bit Data Transfer: Enables 32-bit data transfer.

→ Type [Auto]

Use the **Type** BIOS option select the type of device the AMIBIOS attempts to boot from after the Power-On Self-Test (POST) is complete.

- | | | |
|---|----------------------------|---|
| → | Not Installed | BIOS is prevented from searching for an IDE disk drive on the specified channel. |
| → | Auto DEFAULT | The BIOS auto detects the IDE disk drive type attached to the specified channel. This setting should be used if an IDE hard disk drive is attached to the specified channel. |
| → | CD/DVD | The CD/DVD option specifies that an IDE CD-ROM drive is attached to the specified IDE channel. The BIOS does not attempt to search for other types of IDE disk drives on the specified channel. |
| → | ARMD | This option specifies an ATAPI Removable Media Device. These include, but are not limited to: <ul style="list-style-type: none"> → ZIP → LS-120 |

→ LBA/Large Mode [Auto]

Use the **LBA/Large Mode** option to disable or enable BIOS to auto detects LBA (Logical Block Addressing). LBA is a method of addressing data on a disk drive. In LBA mode, the maximum drive capacity is 137 GB.

→ Disabled BIOS is prevented from using the LBA mode control on the specified channel.

→ Auto **DEFAULT** BIOS auto detects the LBA mode control on the specified channel.

→ Block (Multi Sector Transfer) [Auto]

Use the **Block (Multi Sector Transfer)** to disable or enable BIOS to auto detect if the device supports multi-sector transfers.

→ Disabled BIOS is prevented from using Multi-Sector Transfer on the specified channel. The data to and from the device occurs one sector at a time.

→ Auto **DEFAULT** BIOS auto detects Multi-Sector Transfer support on the drive on the specified channel. If supported the data transfer to and from the device occurs multiple sectors at a time.

→ PIO Mode [Auto]

Use the **PIO Mode** option to select the IDE PIO (Programmable I/O) mode program timing cycles between the IDE drive and the programmable IDE controller. As the PIO mode increases, the cycle time decreases.

→ Auto **DEFAULT** BIOS auto detects the PIO mode. Use this value if the IDE disk drive support cannot be determined.

IMB-Q354 uATX Motherboard

- **0** PIO mode 0 selected with a maximum transfer rate of 3.3MBps
- **1** PIO mode 1 selected with a maximum transfer rate of 5.2MBps
- **2** PIO mode 2 selected with a maximum transfer rate of 8.3MBps
- **3** PIO mode 3 selected with a maximum transfer rate of 11.1MBps
- **4** PIO mode 4 selected with a maximum transfer rate of 16.6MBps
(This setting generally works with all hard disk drives manufactured after 1999. For other disk drives, such as IDE CD-ROM drives, check the specifications of the drive.)

→ **DMA Mode [Auto]**

Use the **DMA Mode** BIOS selection to adjust the DMA mode options.

- **Auto** **DEFAULT** BIOS auto detects the DMA mode. Use this value if the IDE disk drive support cannot be determined.
- **SWDMA0** Single Word DMA mode 0 selected with a maximum data transfer rate of 2.1MBps
- **SWDMA1** Single Word DMA mode 1 selected with a maximum data transfer rate of 4.2MBps
- **SWDMA2** Single Word DMA mode 2 selected with a maximum data transfer rate of 8.3MBps
- **MWDMA0** Multi Word DMA mode 0 selected with a maximum data transfer rate of 4.2MBps
- **MWDMA1** Multi Word DMA mode 1 selected with a maximum data transfer rate of 13.3MBps
- **MWDMA2** Multi Word DMA mode 2 selected with a maximum data transfer rate of 16.6MBps

- **UDMA1** Ultra DMA mode 0 selected with a maximum data transfer rate of 16.6MBps
- **UDMA1** Ultra DMA mode 1 selected with a maximum data transfer rate of 25MBps
- **UDMA2** Ultra DMA mode 2 selected with a maximum data transfer rate of 33.3MBps
- **UDMA3** Ultra DMA mode 3 selected with a maximum data transfer rate of 44MBps (To use this mode, it is required that an 80-conductor ATA cable is used.)
- **UDMA4** Ultra DMA mode 4 selected with a maximum data transfer rate of 66.6MBps (To use this mode, it is required that an 80-conductor ATA cable is used.)
- **UDMA5** Ultra DMA mode 5 selected with a maximum data transfer rate of 99.9MBps (To use this mode, it is required that an 80-conductor ATA cable is used.)

→ **S.M.A.R.T [Auto]**

Use the **S.M.A.R.T** option to auto-detect, disable or enable Self-Monitoring Analysis and Reporting Technology (SMART) on the drive on the specified channel. **S.M.A.R.T** predicts impending drive failures. The **S.M.A.R.T** BIOS option enables or disables this function.

- **Auto** **DEFAULT** BIOS auto detects HDD SMART support.
- **Disabled** Prevents BIOS from using the HDD SMART feature.
- **Enabled** Allows BIOS to use the HDD SMART feature

→ **32Bit Data Transfer [Enabled]**

Use the **32Bit Data Transfer** BIOS option to enables or disable 32-bit data transfers.

IMB-Q354 uATX Motherboard

- ➔ **Disabled** Prevents the BIOS from using 32-bit data transfers.
- ➔ **Enabled** **DEFAULT** Allows BIOS to use 32-bit data transfers on supported hard disk drives.

6.3.3 Floppy Configuration

Use the **Floppy Configuration** menu to configure the floppy disk drive connected to the system.

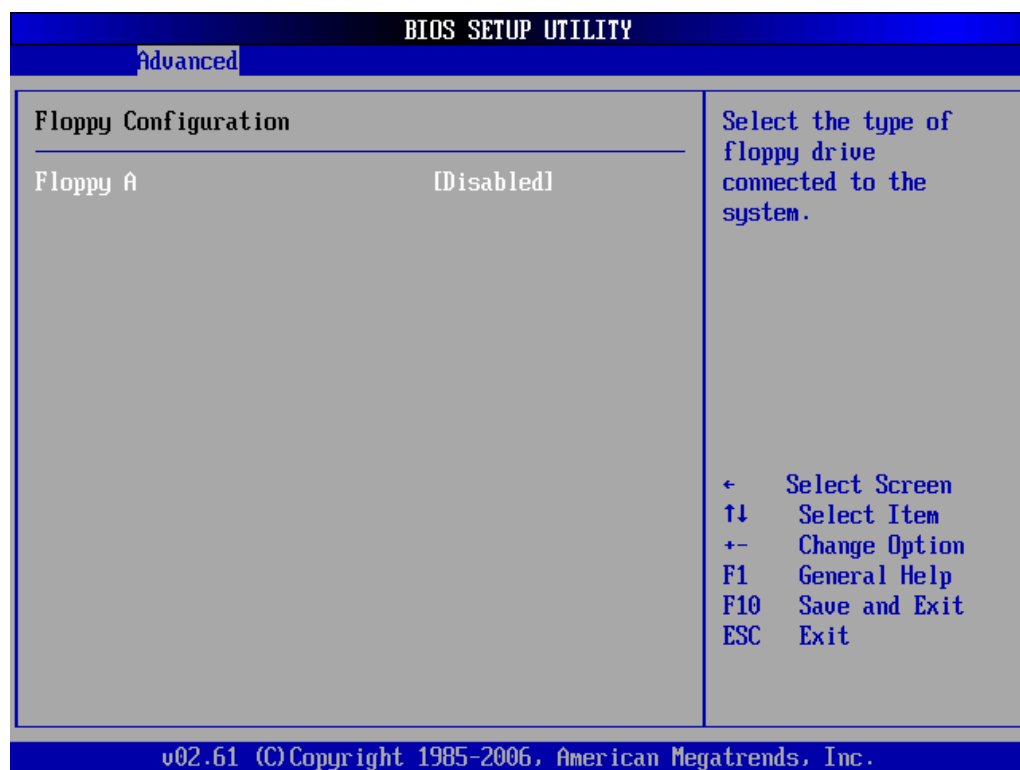

BIOS Menu 6: IDE Master and IDE Slave Configuration

➔ Floppy A

Use the **Floppy A** option to configure the floppy disk drive. Options are listed below:

- Disabled
- 360 KB 5 1/4"
- 1.2 MB 5 1/4"

- 720 KB 31/2"
- 1.44 MB 31/2'
- 2.88 MB 31/2"

6.3.4 Super IO Configuration

Use the **Super IO Configuration** menu (**BIOS Menu 7**) to set or change the configurations for the FDD controllers, parallel ports and serial ports.

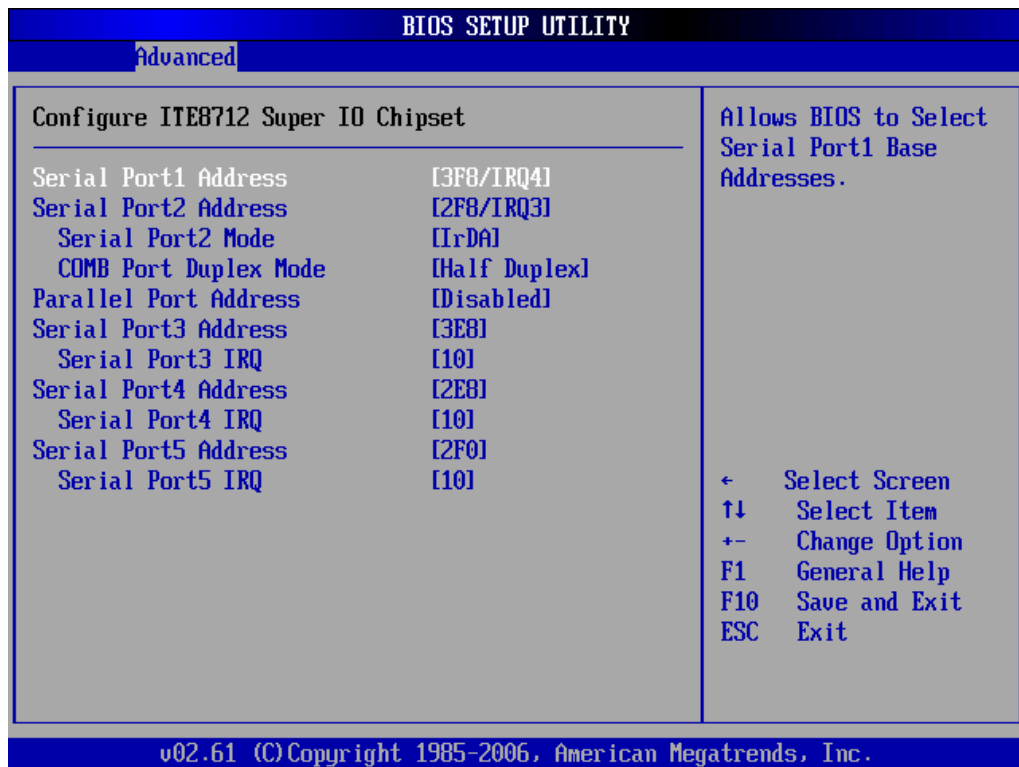

BIOS Menu 7: Super IO Configuration

→ Serial Port1 Address [3F8/IRQ4]

Use the **Serial Port1 Address** option to select the Serial Port 1 base address.

- **Disabled** No base address is assigned to Serial Port 1
- **3F8/IRQ4** **DEFAULT** Serial Port 1 I/O port address is 3F8 and the interrupt address is IRQ4

IMB-Q354 uATX Motherboard

➔ **3E8/IRQ4** Serial Port 1 I/O port address is 3E8 and the interrupt address is IRQ4

➔ **2E8/IRQ3** Serial Port 1 I/O port address is 2E8 and the interrupt address is IRQ3

➔ Serial Port2 Address [2F8/IRQ3] (For Infrared ONLY)

Use the **Serial Port2 Address** option to select the Serial Port 2 base address.

➔ **Disabled** No base address is assigned to Serial Port 2

➔ **2F8/IRQ3** **DEFAULT** Serial Port 2 I/O port address is 3F8 and the interrupt address is IRQ3

➔ **3E8/IRQ4** Serial Port 2 I/O port address is 3E8 and the interrupt address is IRQ4

➔ **2E8/IRQ3** Serial Port 2 I/O port address is 2E8 and the interrupt address is IRQ3

➔ Serial Port2 Mode [IrDA]

Use the **Serial Port2 Mode** option to select the Serial Port2 operational mode.

➔ **IrDA** **DEFAULT** Serial Port 2 mode is IrDA

➔ **ASK IR** Serial Port 2 mode is ASK IR

➔ COMB Port Duplex Mode [Half Duplex]

Use the **COMB Port Duplex Mode** option to select the COM port operational mode.

➔ **Half Duplex** **DEFAULT** COM port mode is half-duplex

➔ **Full Duplex** COM port mode is full-duplex

→ Parallel Port Address [Disabled]

Use the **Parallel Port Address** option to select the parallel port base address.

- **Disabled** **DEFAULT** No base address is assigned to the Parallel Port
- **378** Parallel Port I/O port address is 378
- **278** Parallel Port I/O port address is 278
- **3BC** Parallel Port I/O port address is 3BC

→ Serial Port3 Address [3E8] (For COM2)

Use the **Serial Port3 Address** option to select the base addresses for serial port 3.

- **Disabled** No base address is assigned to serial port 3
- **3E8** **DEFAULT** Serial port 3 I/O port address is 3E8
- **2E8** Serial port 3 I/O port address is 2E8
- **2E0** Serial port 3 I/O port address is 2E0

→ Serial Port3 IRQ [10]

Use the **Serial Port3 IRQ** option to select the interrupt address for serial port 3.

- **4** Serial port 3 IRQ address is 4
- **9** Serial port 3 IRQ address is 9
- **10** **DEFAULT** Serial port 3 IRQ address is 10
- **11** Serial port 3 IRQ address is 11

→ Serial Port4 Address [2E8] (For COM3)

Use the **Serial Port4 IRQ** option to select the interrupt address for serial port 4.

IMB-Q354 uATX Motherboard

- **Disabled** No base address is assigned to serial port 3
- **3E8** Serial port 4 I/O port address is 3E8
- **2E8** **DEFAULT** Serial port 4 I/O port address is 2E8
- **2E0** Serial port 4 I/O port address is 2E0

→ **Serial Port4 IRQ [10]**

Use the **Serial Port4 IRQ** option to select the interrupt address for serial port 4.

- **3** **DEFAULT** Serial port 4 IRQ address is 3
- **9** Serial port 4 IRQ address is 9
- **10** **DEFAULT** Serial port 4 IRQ address is 10
- **11** Serial port 4 IRQ address is 11

→ **Serial Port5 Address [2F0] (For COM4)**

Use the **Serial Port5 IRQ** option to select the interrupt address for serial port 5.

- **Disabled** No base address is assigned to serial port 5
- **3E8** Serial port 5 I/O port address is 3E8
- **2E8** Serial port 5 I/O port address is 2E8
- **2F0** **DEFAULT** Serial port 5 I/O port address is 2F0
- **2D0** Serial port 5 I/O port address is 2D0

→ **Serial Port5 IRQ [10]**

Use the **Serial Port5 IRQ** option to select the interrupt address for serial port 5.

- **10** **DEFAULT** Serial port 5 IRQ address is 10

→ 11

Serial port 5 IRQ address is 11

6.3.5 Hardware Health Configuration

The **Hardware Health Configuration** menu (**BIOS Menu 8**) shows the operating temperature, fan speeds and system voltages.

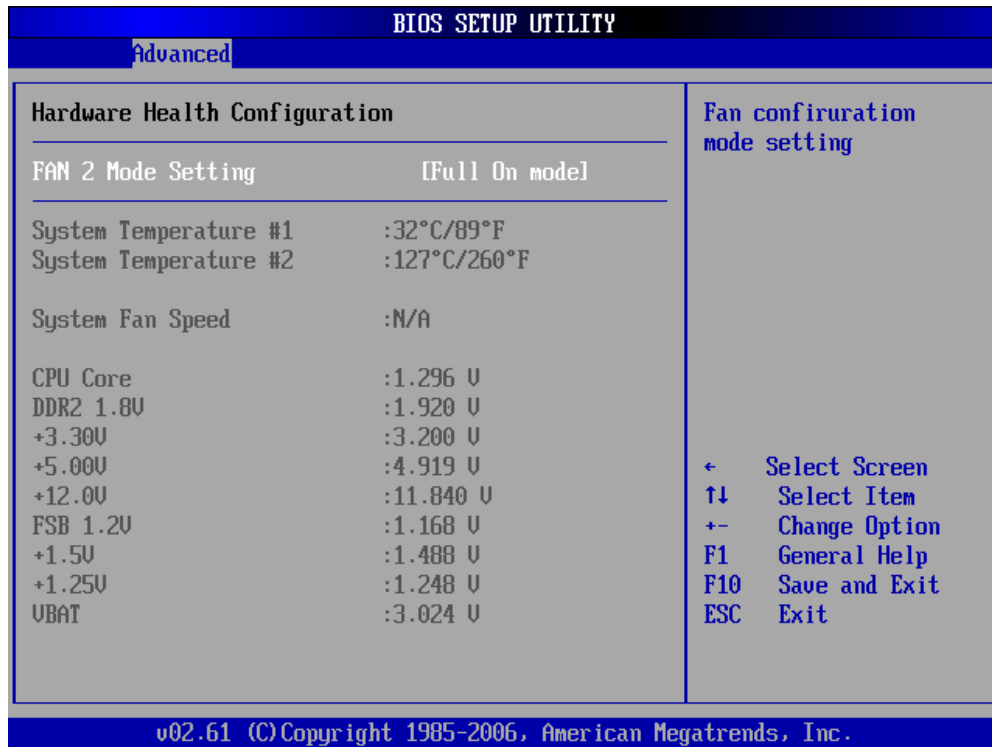

BIOS Menu 8: Hardware Health Configuration

→ FAN 2 Mode Setting [Full On Mode]

Use the **FAN 2 Mode Setting** option to configure the second fan.

- **Full On Mode** Fan is on all the time
- **Automatic mode** **DEFAULT** Fan is off when the temperature is low enough. Parameters must be set by the user.

IMB-Q354 uATX Motherboard

→ PWM Manual mode

Pulse width modulation set manually

The following system parameters and values are shown. The system parameters that are monitored are:

- System Temperatures: The following system temperatures are monitored
 - System Temperature #1
 - System Temperature #2
- Fan Speeds: The CPU cooling fan speed is monitored.
 - System Fan Speed
- Voltages: The following system voltages are monitored
 - CPU Core
 - DDR2 1.8V
 - +3.3V
 - +5V
 - +12V
 - FSB 1.2V
 - +1.5V
 - +1.25V
 - VBAT

6.3.6 ACPI Configuration

The **ACPI Configuration** menu (**BIOS Menu 9**) configures the Advanced Configuration and Power Interface (ACPI) .

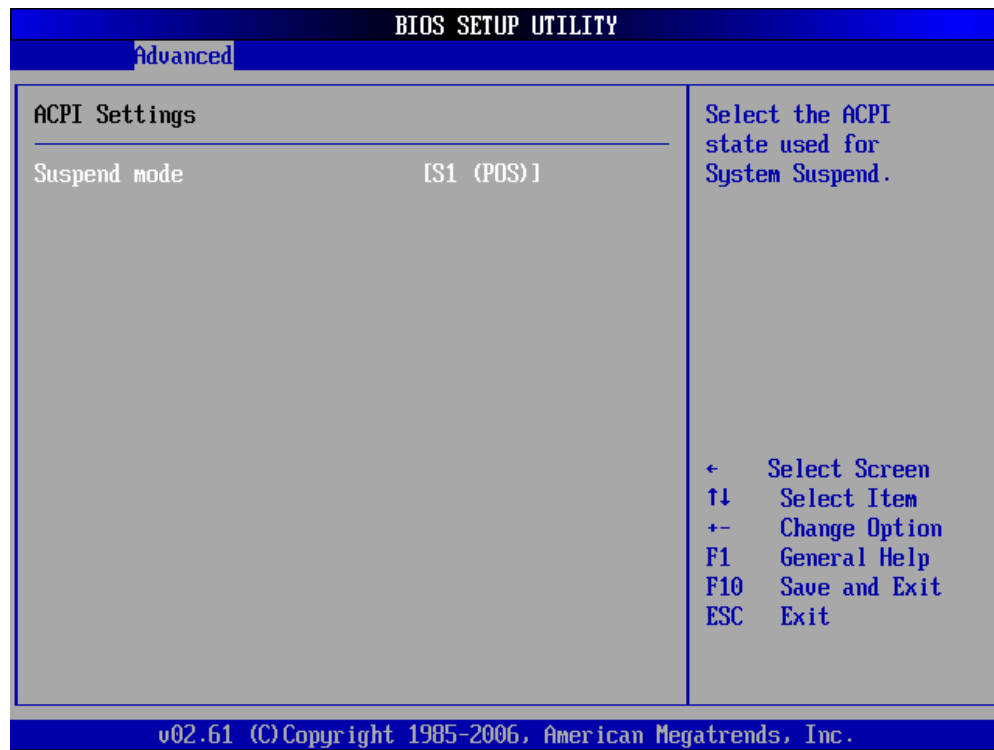

BIOS Menu 9: ACPI Configuration

→ Suspend Mode [S1(POS)]

Use the **Suspend Mode** option to specify the sleep state the system enters when it is not being used.

- **S1 (POS) DEFAULT** The system enters S1(POS) sleep state. The system appears off. The CPU is stopped; RAM is refreshed; the system is running in a low power mode.

6.3.7 AHCI Configuration



Advanced Host Controller Interface (AHCI) is a new programming interface for SATA host controllers. AHCI systems do not have

IMB-Q354 uATX Motherboard

master/slave designation for SATA devices, each device is treated as a master, and hardware-assisted native command queuing.

Use the **AHCI Settings** menu (**BIOS Menu 10**) to report on the auto-detection of devices connected to the onboard SATA drive connectors.

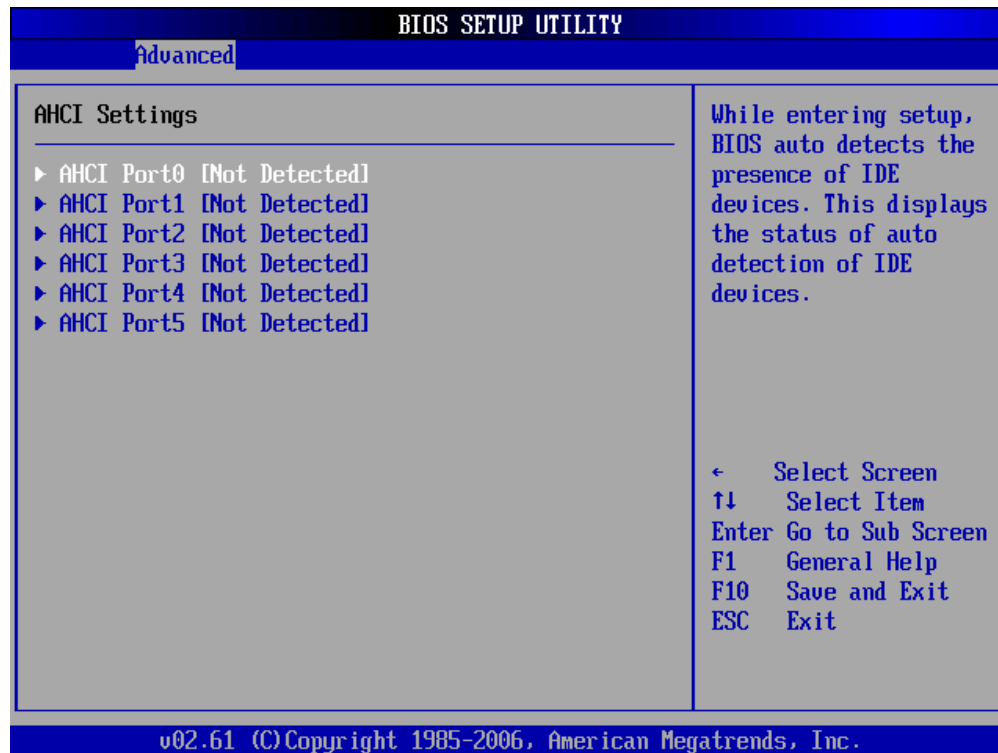

BIOS Menu 10: AHCI Configuration

→ AHCI Port n [Not Detected]

Use the **AHCI Port n** BIOS option to check what AHCI (Advanced Host Controller Interface) devices are detected to a specified SATA drive connector. If a device is detected, selecting the BIOS option, e.g. “**AHCI Port 3**” opens a new window.

6.3.7.1 AHCI Port n

Use the **AHCI Port n** configuration menu (**BIOS Menu 11**) to configure the drive connected to SATA connector n.

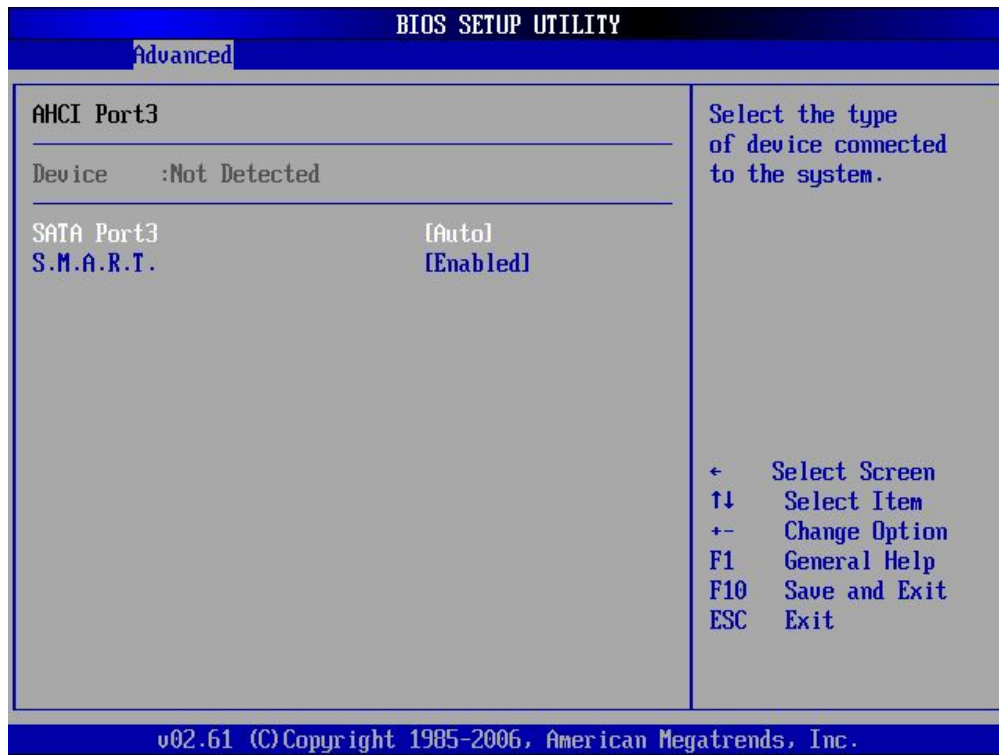

BIOS Menu 11: AHCI Port n Configuration Menu

→ SATA Port n [Auto]

Use the **SATA Port n** option to enable the system to auto-detect the type of drive connected to SATA drive connector n.

→ S.M.A.R.T [Enabled]

Use the **S.M.A.R.T** option to enable S.M.A.R.T (Self-Monitoring, Analysis, and Reporting Technology) on the drive connected to SATA drive connector n.

→ **Enabled** **DEFAULT** S.M.A.R.T is enabled on the drive connected to SATA drive connector n on the system

→ **Disabled** S.M.A.R.T is disabled on the drive connected to SATA drive connector n on the system

6.3.8 Intel AMT Configuration

The **Intel AMT Configuration** menu (**BIOS Menu 12**) configures the Intel® Active Management Technology (AMT) options.

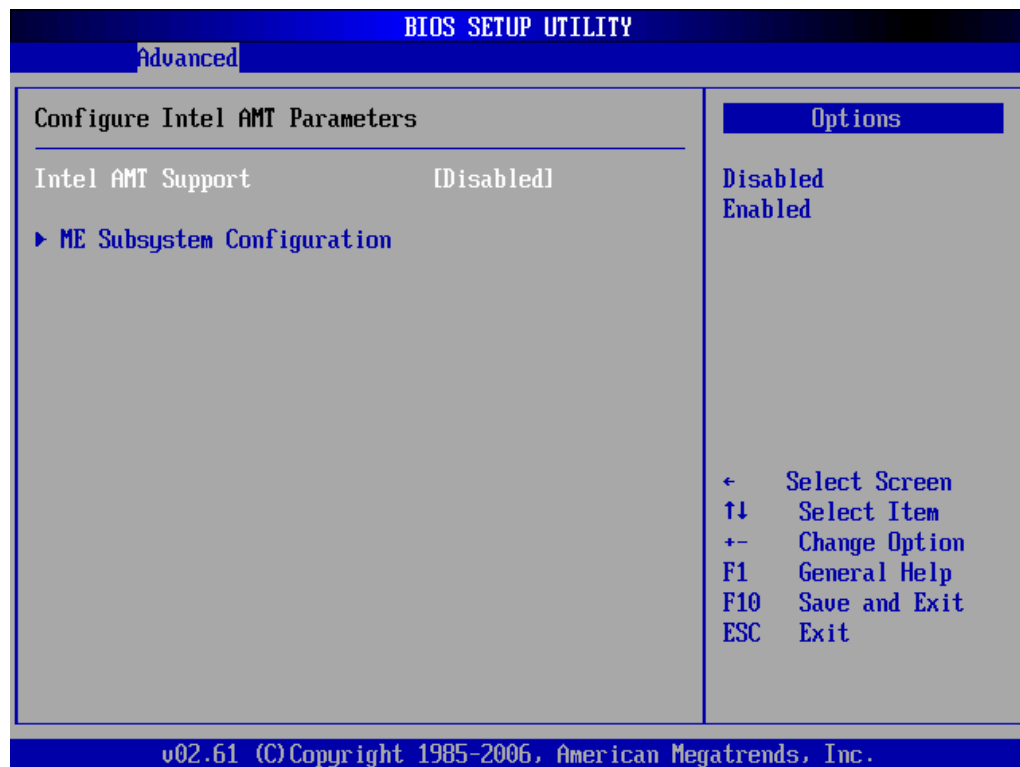

BIOS Menu 12: Intel AMT Configuration

→ Intel AMT Support [Enable]

Use the **Intel AMT Support** option to enable or disable the Intel AMT support.

- **Disabled** The Intel® AMT function is disabled.
- **Enabled** **DEFAULT** The Intel® AMT function is enabled.

6.3.8.1 ME Subsystem Configuration

The **ME Subsystem Configuration** menu (**BIOS Menu 13**) allows the AMT subsystem (Management Engine, ME) and Host Embedded Controller Interface (HECI) driver options to be configured.

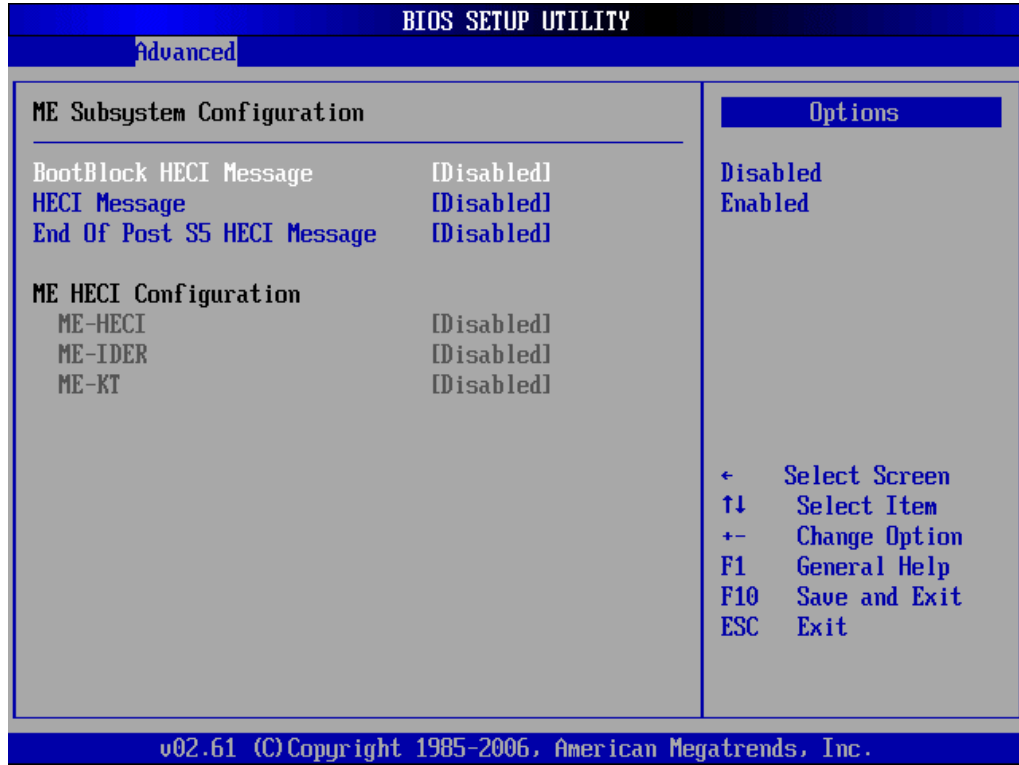

BIOS Menu 13: Me Subsystem Configuration

→ BootBlock HECI Message [Disabled]

Use the **BootBlock HECI Message** option to enable or disable HECI message when booting up the system.

- **Disabled** **DEFAULT** The HECI message is disabled when booting up the system.
- **Enabled** The HECI message is enabled when booting up the system.

→ HECI Message [Disabled]

Use the **HECI Message** BIOS option to enable or disable HECI message.

- **Disabled** **DEFAULT** The HECI message disabled.

IMB-Q354 uATX Motherboard

→ **Enabled** The HECI message enabled.

→ **End Of Post S5 HECI Message [Disabled]**

Use the **End Of Post S5 HECI Message** option to enable or disable HECI message when the system is in the off (S5) state.

→ **Disabled** **DEFAULT** The HECI message is disabled when the system is off.

→ **Enabled** The HECI message enabled when the system is off.

→ **ME-HECI [Disabled]**

The **ME-HECI** option is disabled by default and can not be changed.

→ **ME-IDER [Disabled]**

Use the **ME-IDER** option to enable or disable the IDE-Redirection (IDE-R) function on an AMT-capable system.

→ **Disabled** **DEFAULT** The IDE-R function is disabled.

→ **Enabled** The IDE-R function allows an AMT-capable client system to access IDE devices and load OS from a management system. When an IDE-R session is established, the virtual drives are shown in the system.

→ **ME-KT [Disabled]**

Use the **ME-KT** option to enable or disable the Keyboard and Text redirection (KT) function on an AMT-capable system. KT is also known as Serial-Over-Lan (SOL).

→ **Disabled** **DEFAULT** The KT function of the ME is disabled.

→ **Enabled** The KT function allows a management system to control an Intel® AMT client system remotely. The keyboard

interface of a managed client system, such as BIOS menu, is displayed through the management system.

6.3.9 Remote Access Configuration

Use the **Remote Access Configuration** menu (**BIOS Menu 14**) to configure remote access parameters. The **Remote Access Configuration** is an AMIBIOS feature and allows a remote host running a terminal program to display and configure the BIOS settings.

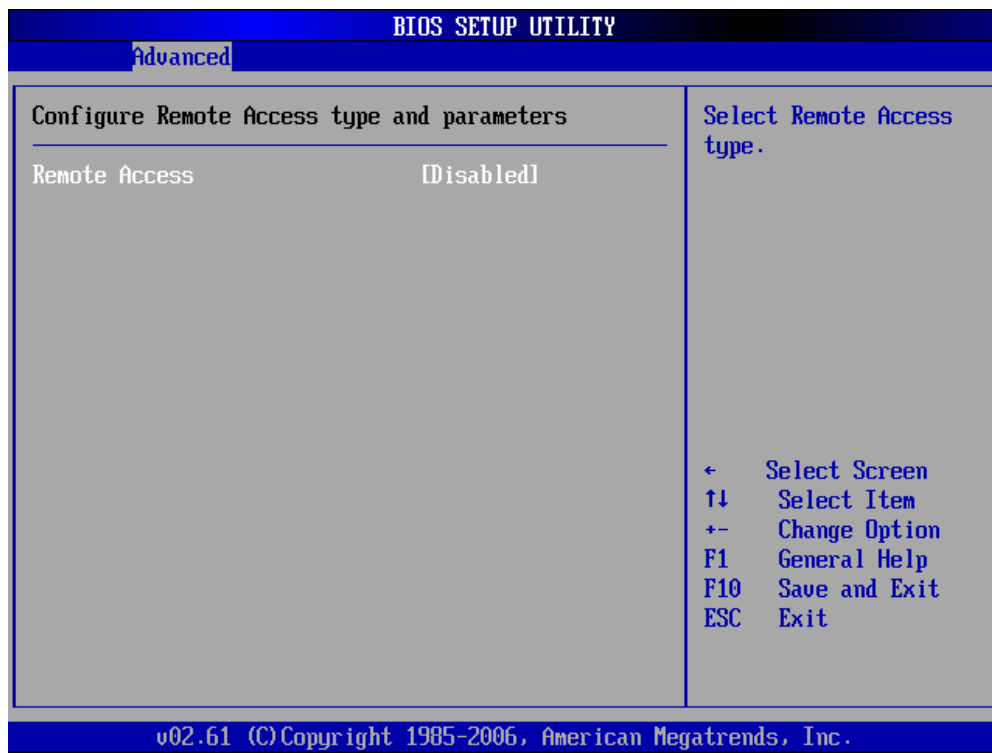

BIOS Menu 14: Remote Access Configuration [Advanced]

➔ Remote Access [Disabled]

Use the **Remote Access** option to enable or disable access to the remote functionalities of the system.

➔ **Disabled** **DEFAULT** Remote access is disabled.

→ **Enabled**

Remote access configuration options shown below appear:

- **Serial Port Number**
- **Serial Port Mode**
- **Flow Control**
- **Redirection after BIOS POST**
- **Terminal Type**
- **VT-UTF8 Combo Key Support**

These configuration options are discussed below.

6.3.10 Trusted Computing

Use the **Trusted Computing** menu (**BIOS Menu 15**) to configure settings related to the Trusted Computing Group (TCG) Trusted Platform Module (TPM).

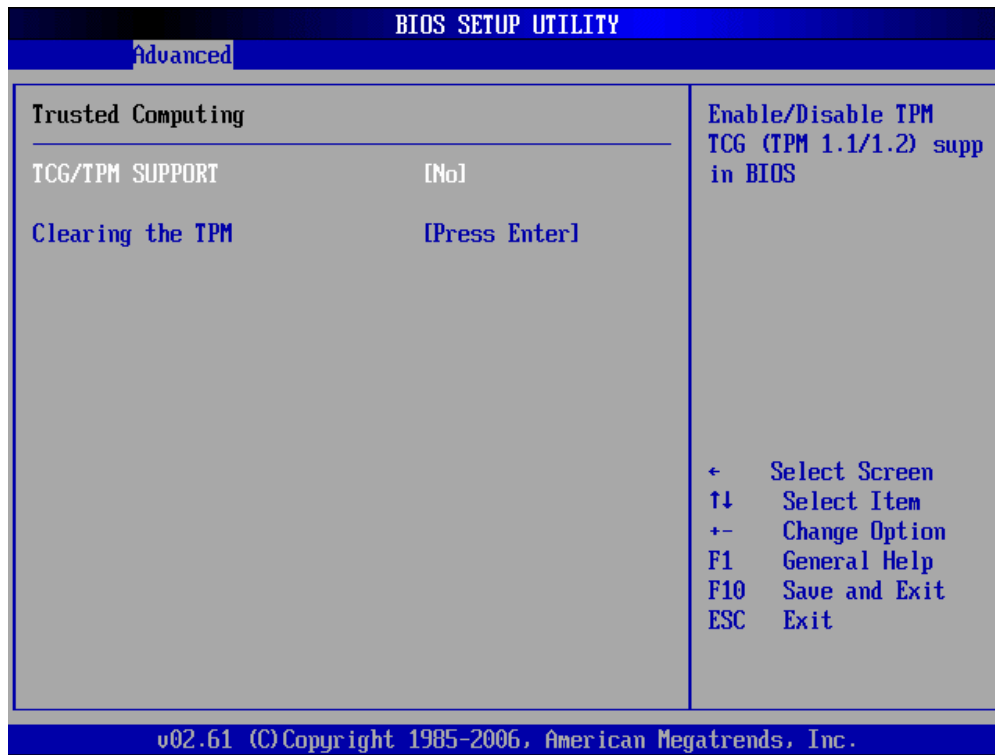

BIOS Menu 15: Trusted Computing

→ TCG/TPM Support [No]

Use the **TCG/TPM Support** option to configure support for the TPM.

- **No** **DEFAULT** TPM support is disabled.
- **Yes** TPM support is enabled.

→ Clearing the TPM [Press Enter]

Use the **Clearing the TPM** option to clear the information stored in the TPM.

6.3.11 USB Configuration

Use the **USB Configuration** menu (**BIOS Menu 16**) to read USB configuration information and configure the USB settings.

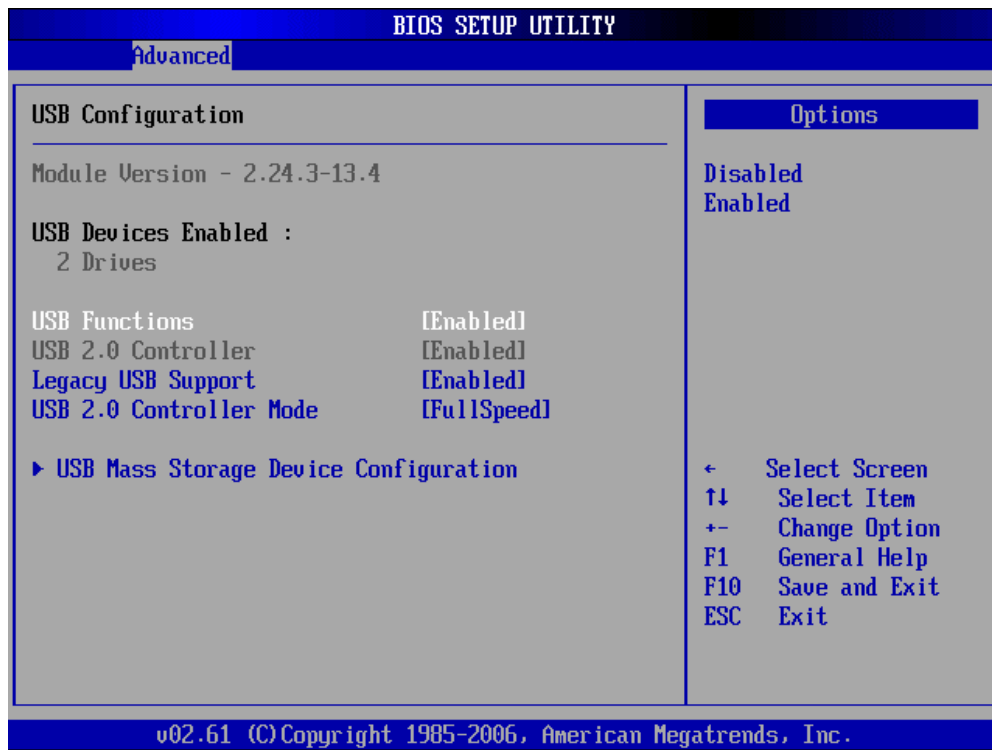

BIOS Menu 16: USB Configuration

➔ USB Configuration

The **USB Configuration** field shows the system USB configuration. The items listed are:

- Module Version: x.xxxxx.xxxxx

➔ USB Devices Enabled

The **USB Devices Enabled** field lists the USB devices that are enabled on the system

➔ USB Function [Enabled]

Use the **USB Function** BIOS option to enable or disable USB function support.

- ➔ **Disabled** USB function support disabled
- ➔ **Enabled** **DEFAULT** USB function support enabled

→ USB 2.0 Controller [Enabled]

Use the **USB 2.0 Controller** BIOS option to enable or disable the USB 2.0 controller

- **Disabled** USB 2.0 controller disabled
- **Enabled** **DEFAULT** USB 2.0 controller enabled

→ Legacy USB Support [Enabled]

Use the **Legacy USB Support** BIOS option to enable USB mouse and USB keyboard support.

Normally if this option is not enabled, any attached USB mouse or USB keyboard does not become available until a USB compatible operating system is fully booted with all USB drivers loaded. When this option is enabled, any attached USB mouse or USB keyboard can control the system even when there is no USB driver loaded onto the system.

- **Disabled** Legacy USB support disabled
- **Enabled** **DEFAULT** Legacy USB support enabled
- **Auto** Legacy USB support disabled if no USB devices are connected

→ USB2.0 Controller Mode [FullSpeed]

Use the **USB2.0 Controller Mode** option to set the speed of the USB2.0 controller.

- **FullSpeed** **DEFAULT** The controller is capable of operating at 12Mb/s
- **HiSpeed** The controller is capable of operating at 480Mb/s

6.3.11.1 USB Mass Storage Device Configuration

Use the **USB Mass Storage Device Configuration** menu (**BIOS Menu 17**) to configure USB mass storage class devices.

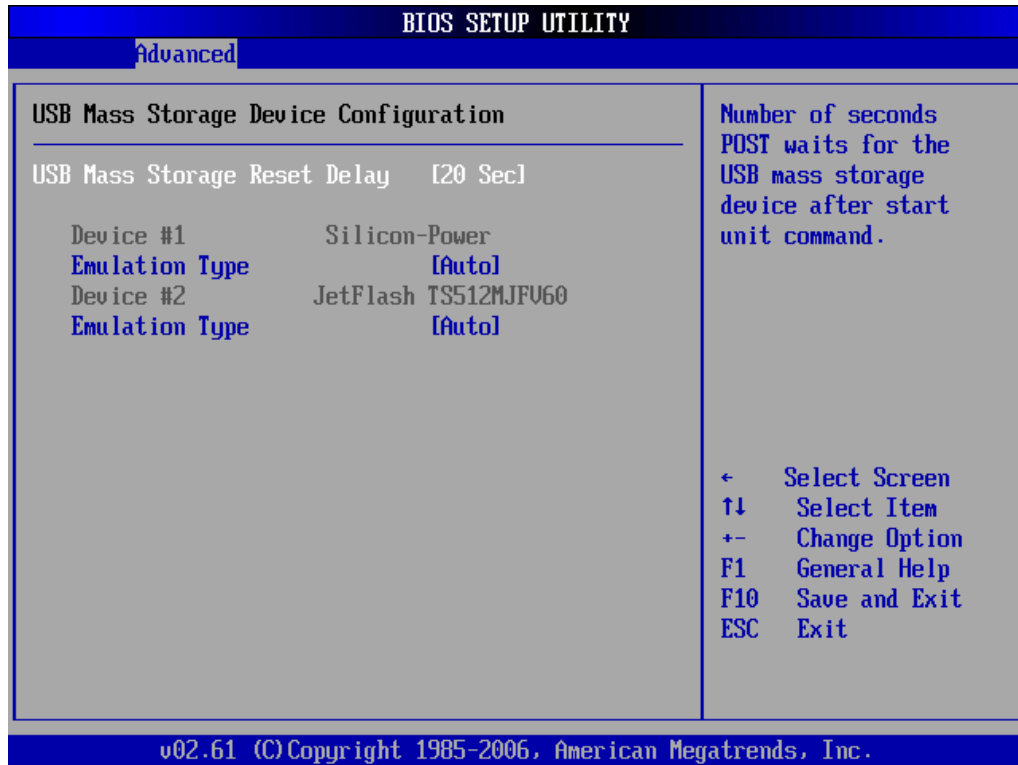

BIOS Menu 17: USB Mass Storage Device Configuration

➔ **USB Mass Storage Reset Delay [20 Sec]**

Use the **USB Mass Storage Reset Delay** option to set the number of seconds POST waits for the USB mass storage device after the start unit command.

- ➔ **10 Sec** POST waits 10 seconds for the USB mass storage device after the start unit command.
- ➔ **20 Sec** **DEFAULT** POST waits 20 seconds for the USB mass storage device after the start unit command.
- ➔ **30 Sec** POST waits 30 seconds for the USB mass storage device after the start unit command.
- ➔ **40 Sec** POST waits 40 seconds for the USB mass storage device after the start unit command.

→ Device ##

The **Device##** field lists the USB devices that are connected to the system.

→ Emulation Type [Auto]

Use the **Emulation Type** BIOS option to specify the type of emulation BIOS has to provide for the USB device.

**NOTE:**

Please note that the device's formatted type and the emulation type provided by the BIOS must match for a device to boot properly. If both types do not match then device's behavior is undefined. To make sure both types match, format the device using BIOS INT13h calls after selecting the proper emulation option in BIOS setup. The FORMAT utility provided by Microsoft® MS-DOS®, Microsoft® Windows® 95, and Microsoft® Windows® 98 can be used for this purpose.

- | | | |
|---------------------|----------------|--|
| → Auto | DEFAULT | BIOS auto-detects the current USB. |
| → Floppy | | The USB device will be emulated as a floppy drive. The device can be either A: or B: responding to INT13h calls that return DL = 0 or DL = 1 respectively. |
| → Forced FDD | | Allows a hard disk image to be connected as a floppy image. This option works only for drives formatted with FAT12, FAT16 or FAT32. |
| → Hard Disk | | Allows the USB device to be emulated as hard disk responding to INT13h calls that return DL values of 80h or above. |

IMB-Q354 uATX Motherboard

→ CDROM

Assumes the CD-ROM is formatted as bootable media. All the devices that support block sizes greater than 512 bytes can only be booted using this option.

6.4 PCI/PnP

Use the **PCI/PnP** menu (**BIOS Menu 18**) to configure advanced PCI and PnP settings.



WARNING!

Setting wrong values for the BIOS selections in the PCI/PnP BIOS menu may cause the system to malfunction.



BIOS Menu 18: PCI/PnP Configuration

→ IRQ# [Available]

Use the **IRQ#** address to specify what IRQs can be assigned to a particular peripheral device.

Available	DEFAULT	The specified IRQ is available to be used by PCI/PnP devices
Reserved		The specified IRQ is reserved for use by Legacy ISA devices

Available IRQ addresses are:

- IRQ3
- IRQ4
- IRQ5
- IRQ7
- IRQ9
- IRQ10
- IRQ 11
- IRQ 14
- IRQ 15

→ DMA Channel# [Available]

Use the **DMA Channel#** option to assign a specific DMA channel to a particular PCI/PnP device.

→ Available	DEFAULT	The specified DMA is available to be used by PCI/PnP devices
→ Reserved		The specified DMA is reserved for use by Legacy ISA devices

Available DMA Channels are:

- DM Channel 0

IMB-Q354 uATX Motherboard

- DM Channel 1
- DM Channel 3
- DM Channel 5
- DM Channel 6
- DM Channel 7

→ Reserved Memory Size [Disabled]

Use the **Reserved Memory Size** BIOS option to specify the amount of memory that should be reserved for legacy ISA devices.

- | | | | |
|---|-----------------|----------------|---|
| → | Disabled | DEFAULT | No memory block reserved for legacy ISA devices |
| → | 16K | | 16KB reserved for legacy ISA devices |
| → | 32K | | 32KB reserved for legacy ISA devices |
| → | 64K | | 54KB reserved for legacy ISA devices |

6.5 Boot

Use the **Boot** menu (**BIOS Menu 19**) to configure system boot options.



BIOS Menu 19: Boot

6.5.1 Boot Settings Configuration

Use the **Boot Settings Configuration** menu (**BIOS Menu 20**) to configure advanced system boot options.

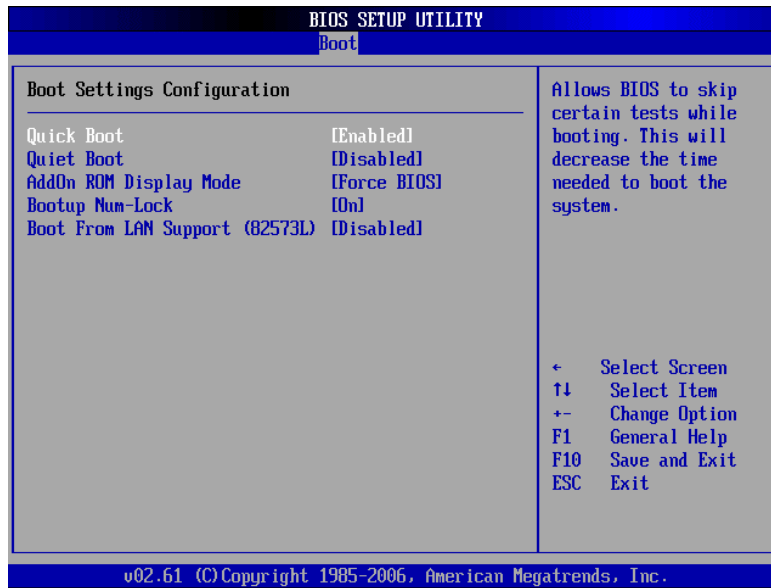

BIOS Menu 20: Boot Settings Configuration

→ Quick Boot [Enabled]

Use the **Quick Boot** BIOS option to make the computer speed up the boot process.

- **Disabled** No POST procedures are skipped
- **Enabled** **DEFAULT** Some POST procedures are skipped to decrease the system boot time

→ Quiet Boot [Disabled]

Use the **Quiet Boot** BIOS option to select the screen display when the system boots.

- **Disabled** **DEFAULT** Normal POST messages displayed
- **Enabled** OEM Logo displayed instead of POST messages

IMB-Q354 uATX Motherboard

→ AddOn ROM Display Mode [Force BIOS]

Use the **AddOn ROM Display Mode** option to allow add-on ROM (read-only memory) messages to be displayed.

- **Force BIOS** **DEFAULT** The system forces third party BIOS to display during system boot.
- **Keep Current** The system displays normal information during system boot.

→ Bootup Num-Lock [On]

Use the **Bootup Num-Lock** BIOS option to specify if the number lock setting must be modified during boot up.

- **Off** Does not enable the keyboard Number Lock automatically. To use the 10-keys on the keyboard, press the Number Lock key located on the upper left-hand corner of the 10-key pad. The Number Lock LED on the keyboard lights up when the Number Lock is engaged.
- **On** **DEFAULT** Allows the Number Lock on the keyboard to be enabled automatically when the computer system boots up. This allows the immediate use of the 10-key numeric keypad located on the right side of the keyboard. To confirm this, the Number Lock LED light on the keyboard is lit.

→ Boot From LAN Support (82573L) [Disabled]



The Intel® ICH9DO Southbridge has an integrated GbE controller. To enable this controller to boot the system, please refer to the

Southbridge BIOS configuration menu.

Use the **BOOT From LAN Support (82573L)** option to enable the Intel® 82573L PCIe GbE controller to boot the system.

- **Disabled** Cannot be booted from a remote system through the Intel® 82573L PCIe GbE controller
- **Enabled DEFAULT** Can be booted from a remote system through the Intel® 82573L PCIe GbE controller

6.5.2 Boot Device Priority

Use the **Boot Device Priority** menu (**BIOS Menu 21**) to specify the boot sequence from the available devices. Possible boot devices may include:

- 1st FLOPPY DRIVE
- HDD
- CD/DVD

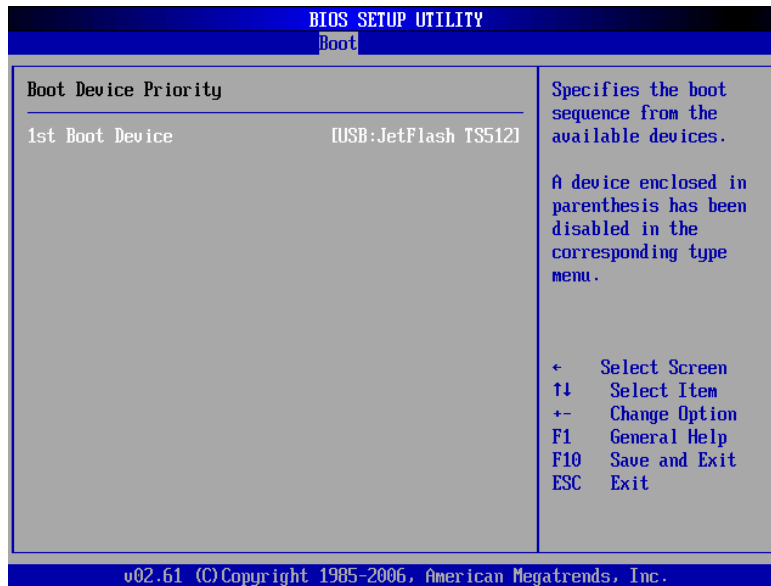

BIOS Menu 21: Boot Device Priority Settings

IMB-Q354 uATX Motherboard

6.5.3 Hard Disk Drives

Use the **Hard Disk Drives** menu to specify the boot sequence of the available HDDs. When the menu is opened, the HDDs connected to the system are listed as shown below:

- 1st Drive [HDD: PM-(part number)]
- 2nd Drive [HDD: PS-(part number)]



Only the drives connected to the system are shown. For example, if only two HDDs are connected only “**1st Drive**” and “**2nd Drive**” are listed.

The boot sequence from the available devices is selected. If the “**1st Drive**” option is selected a list of available HDDs is shown. Select the first HDD the system boots from. If the “**1st Drive**” is not used for booting this option may be disabled.

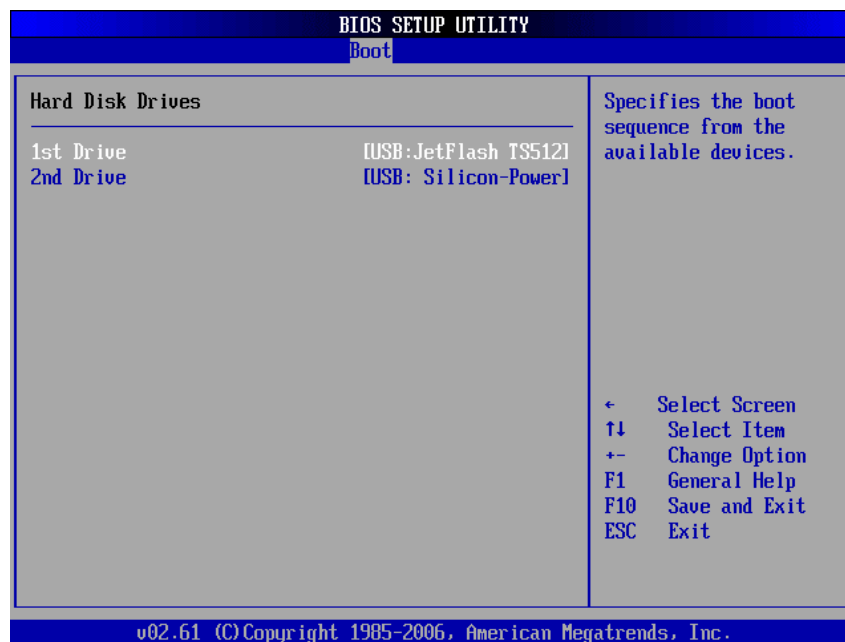

BIOS Menu 22: Hard Disk Drives

6.6 Security

Use the **Security** menu (**BIOS Menu 23**) to set system and user passwords.

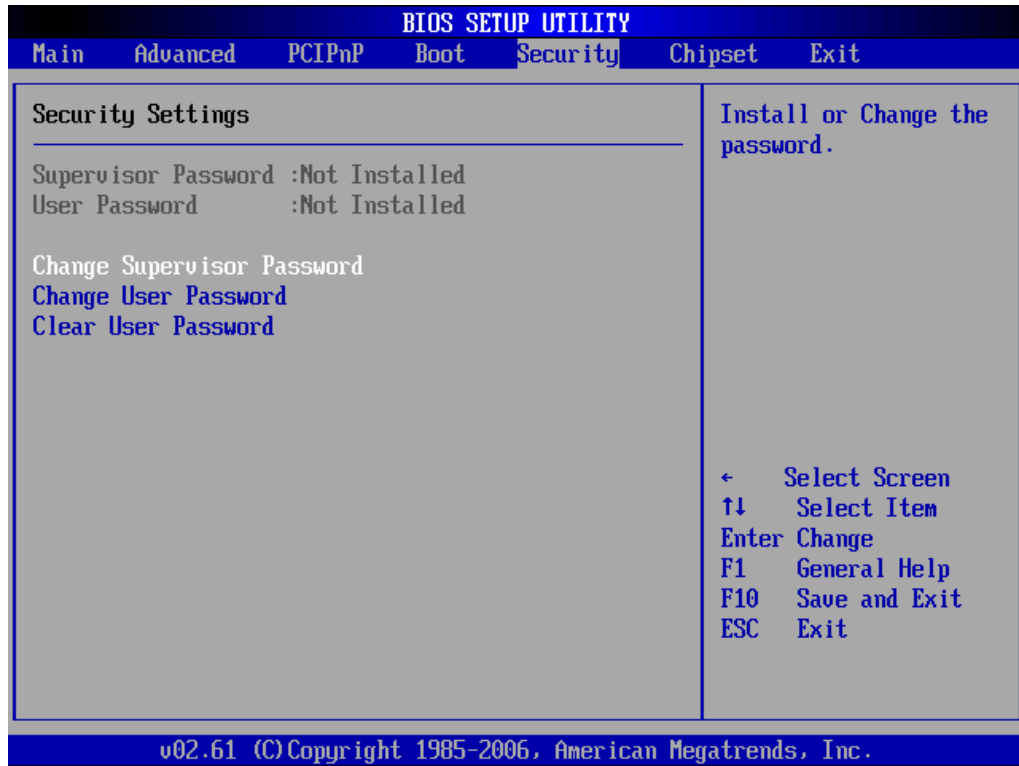

BIOS Menu 23: Security

→ Change Supervisor Password

Use the **Change Supervisor Password** to set or change a supervisor password. The default for this option is **Not Installed**. If a supervisor password must be installed, select this field and enter the password. After the password has been added, **Install** appears next to **Change Supervisor Password**.

→ Change User Password

Use the **Change User Password** to set or change a user password. The default for this option is **Not Installed**. If a user password must be installed, select this field and enter the password. After the password has been added, **Install** appears next to **Change User Password**.

IMB-Q354 uATX Motherboard

→ Clear User Password

Use the **Clear User Password** to clear a user's password. The default for this option is **Not Installed**. If a user password must be cleared, use this option.

6.7 Chipset

Use the **Chipset** menu (**BIOS Menu 24**) to access the Northbridge and Southbridge configuration menus



WARNING!

Setting the wrong values for the Chipset BIOS selections in the Chipset BIOS menu may cause the system to malfunction.



BIOS Menu 24: Chipset

6.7.1 NorthBridge Configuration

Use the **Northbridge Chipset Configuration** menu (**BIOS Menu 25**) to configure the Northbridge chipset.

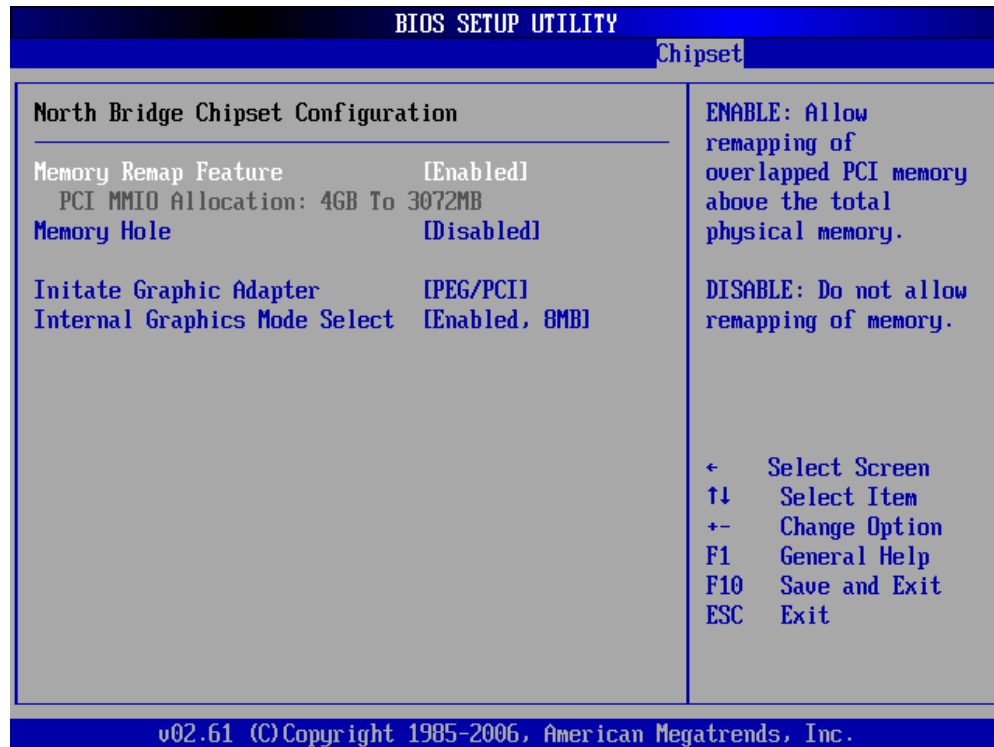

BIOS Menu 25:Northbridge Chipset Configuration

→ Memory Remap Feature [Enabled]

Use the **Memory Remap Feature** option to allow the overlapped PCI memory above the total physical memory to be remapped.

- **Enabled** **DEFAULT** Overlapped PCI memory can be remapped
- **Disabled** Overlapped PCI memory cannot be remapped

→ Memory Hole [Disabled]

Use the **Memory Hole** option to reserve memory space between 15MB and 16MB for ISA expansion cards that require a specified area of memory to work properly. If an older ISA

IMB-Q354 uATX Motherboard

expansion card is used, please refer to the documentation that came with the card to see if it is necessary to reserve the space.

- **Disabled** **DEFAULT** Memory is not reserved for ISA expansion cards
- **15MB – 16MB** Between 15MB and 16MB of memory is reserved for ISA expansion cards

→ **Initiate Graphic Adapter [PEG/PCI]**

Use the **Initiate Graphic Adapter** option to select the graphics controller used as the primary boot device. Select either an integrated graphics controller (IGD) or a combination of PCI graphics controller, a PCI express (PEG) controller or an IGD. Configuration options are listed below:

- IGD
- PEG/IGD
- PEG/PCI **DEFAULT**
- PCI/PEG
- PCI/IGD

→ **Internal Graphics Mode Select [Enable, 8MB]**

Use the **Internal Graphics Mode Select** option to specify the amount of system memory that can be used by the Internal graphics device.

- **Disable**
- **Enable, 1MB** 1MB of memory used by internal graphics device
- **Enable, 8MB** **DEFAULT** 8MB of memory used by internal graphics device

6.7.2 Southbridge Configuration

The **Southbridge Configuration** menu (**BIOS Menu 26**) the Southbridge chipset to be configured.

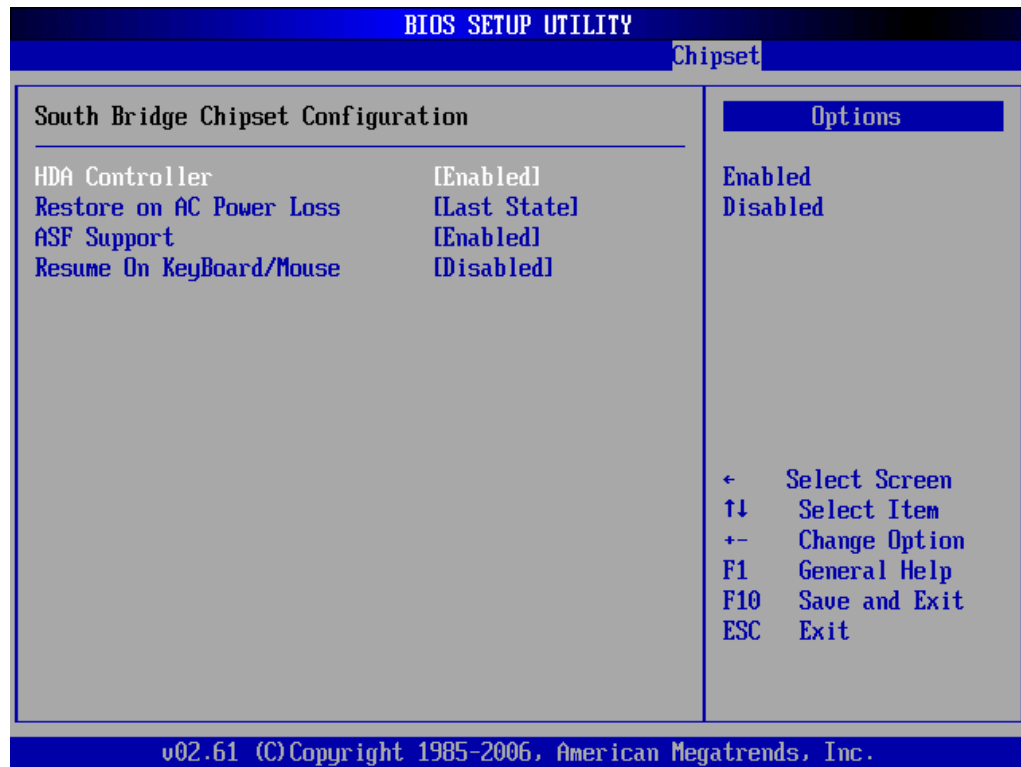

BIOS Menu 26:Southbridge Chipset Configuration

→ HDA Controller [Enabled]

Use the **HDA Controller** option to enable or disable the High Definition audio codec.

- **Disabled** The onboard High Definition audio codec is disabled
- **Enabled DEFAULT** The onboard High Definition audio codec automatically detected and enabled

→ Restore on AC Power Loss [Power Off]

Use the **Restore on AC Power Loss** BIOS option to specify what state the system returns to if there is a sudden loss of power to the system.

IMB-Q354 uATX Motherboard

- **Power Off** The system remains turned off
- **Power On DEFAULT** The system turns on
- **Last State** The system returns to its previous state. If it was on, it turns itself on. If it was off, it remains off.

→ ASF Support [Enabled]

Use the **ASF Support** BIOS option to control the system's ability to connect to a remote management server.

- **Disabled** The system will not communicate with a remote management server.
- **Enabled DEFAULT** The Alert Standard Format (ASF) controller is activated and can communicate with a remote management server.

→ Resume on KeyBoard/Mouse [Disabled]

The **Resume on KeyBoard/Mouse** BIOS option specifies if the system is roused from a suspended or standby state when there is activity on the keyboard or mouse.

- **Disabled DEFAULT** Neither keyboard activity nor mouse activity can rouse the system from a suspend stated.
- **Resume On Wake event only generated by keyboard activity**
Keyboard
- **Resume On Wake event only generated by mouse activity**
Mouse
- **Enabled** Wake event generated by keyboard and mouse activity

6.8 Exit

Use the **Exit** menu (**BIOS Menu 27**) to load default BIOS values, optimal failsafe values and to save configuration changes.

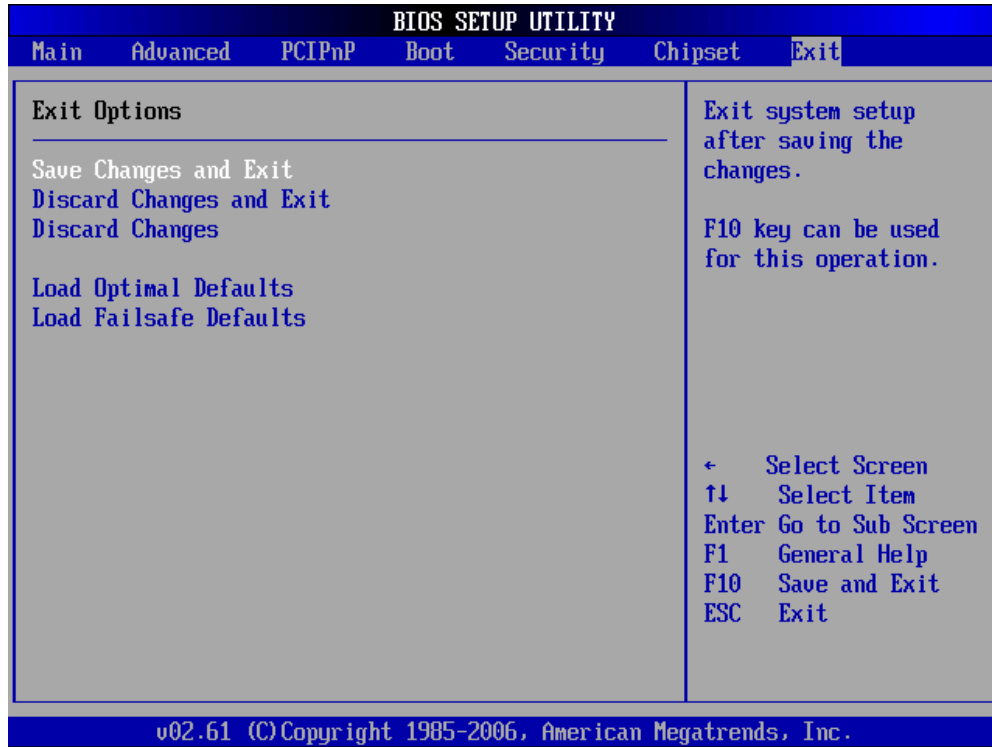

BIOS Menu 27:Exit

→ Save Changes and Exit

Use the **Save Changes and Exit** option to save the changes made to the BIOS options and to exit the BIOS configuration setup program.

→ Discard Changes and Exit

Use the **Discard Changes and Exit** option to exit the BIOS configuration setup program without saving the changes made to the system.

IMB-Q354 uATX Motherboard

→ Discard Changes

Use the **Discard Changes** option to discard the changes and remain in the BIOS configuration setup program.

→ Load Optimal Defaults

Use the **Load Optimal Defaults** option to load the optimal default values for each of the parameters on the Setup menus. **F9 key can be used for this operation.**

→ Load Failsafe Defaults

Use the **Load Failsafe Defaults** option to load failsafe default values for each of the parameters on the Setup menus. **F8 key can be used for this operation.**

THIS PAGE IS INTENTIONALLY LEFT BLANK

Chapter

7

Software Drivers

7.1 Available Software Drivers



NOTE:

The content of the CD may vary throughout the life cycle of the product and is subject to change without prior notice. Visit the IEI website or contact technical support for the latest updates.

The following drivers can be installed on the system:

- Intel® chipset driver
- LAN driver
- Audio driver

Installation instructions are given below.

7.2 Driver CD Auto-run

All the drivers for the IMB-Q354 are on the CD that came with the system. To install the drivers, please follow the steps below.

Step 1: Insert the CD into a CD drive connected to the system.



NOTE:

If the system does not initiate the "autorun" program when the CD is inserted, click the **Start** button, select **Run**, then type **X:\autorun.exe** (where **X:** is the system CD drive) to access the IEI Driver CD main menu.

Step 2: The driver main menu appears (**Figure 7-1**).

IMB-Q354 uATX Motherboard

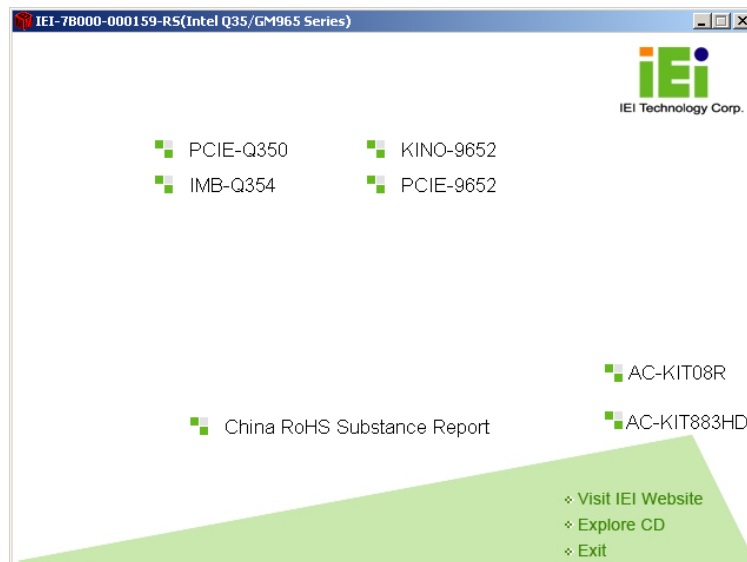

Figure 7-1: Introduction Screen

Step 3: Click IMB-Q354.

Step 4: A new screen with a list of available drivers appears (**Figure 7-2**).



Figure 7-2: Available Drivers

Step 5: Select the driver to install from the list in **Figure 7-2**. Detailed driver installation instructions follow below.

7.3 Intel® Chipset Driver

To install the Intel® chipset driver, please follow the steps below.

Step 1: Select **IMB-Q354** from the list in **Figure 7-1**.

Step 2: Select **INF** from the list in **Figure 7-2**.

Step 3: The window shown in **Figure 7-3** appears.

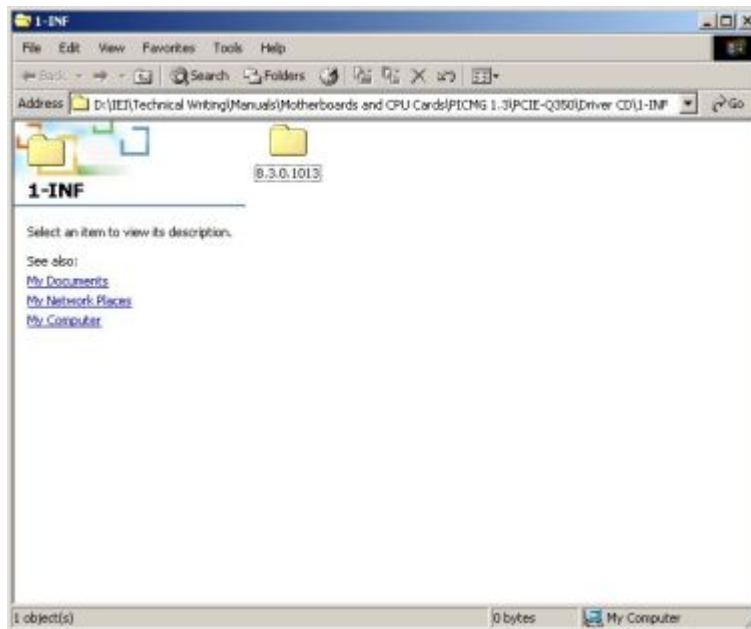

Figure 7-3: Intel® Chipset Driver Directory

Step 4: Click on the directory icon in **Figure 7-3**.

Step 5: The window in **Figure 7-4** appears.

IMB-Q354 uATX Motherboard

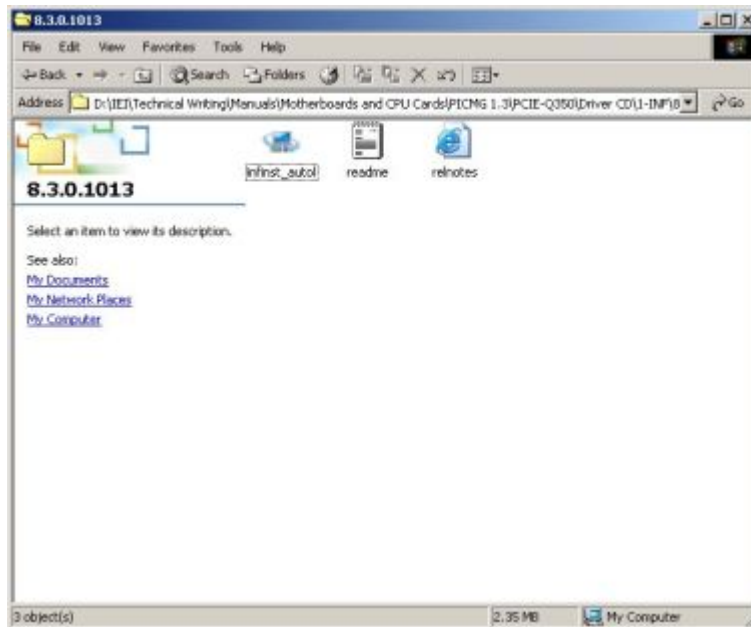

Figure 7-4: Intel® Chipset Driver Setup Icon

Step 6: Click on the `infinst_autol` setup icon in **Figure 7-4**.

Step 7: The **Intel® Package Manager** begins to extract the installation files. See **Figure 7-5**.



Figure 7-5: Intel® Package Manager

Step 8: The Intel® Setup Welcome screen. See Figure 7-6.



Figure 7-6: Intel® Setup Welcome Screen

Step 9: Click **NEXT** to continue.

Step 10: The Intel® license agreement in appears.

IMB-Q354 uATX Motherboard



Figure 7-7: Intel® Chipset Driver License Agreement

Step 11: Accept the terms and conditions by clicking **YES**.

Step 12: The **Readme** file in **Figure 7-8** appears.

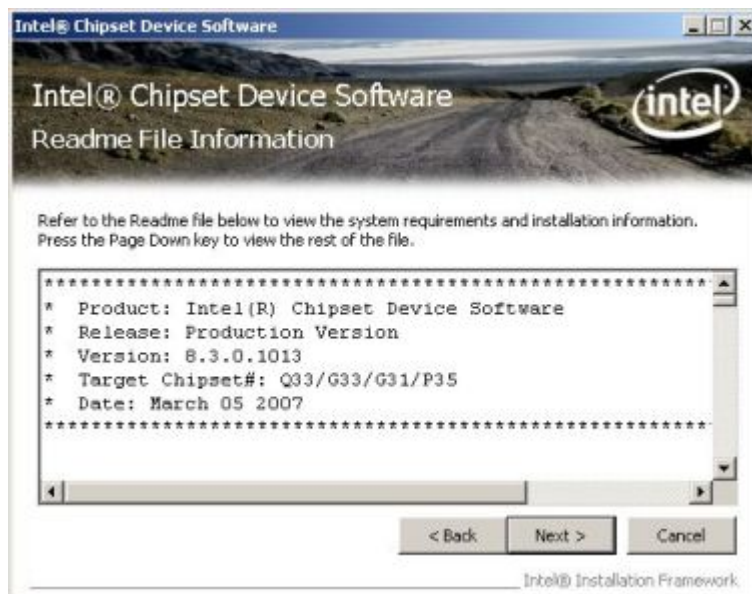

Figure 7-8: Readme File

Step 13: Click **NEXT** to continue.

Step 14: The driver is then installed.

Step 15: When the installation process is complete, the Setup Complete screen appears.

See **Figure 7-9**.



Figure 7-9: Intel® Chipset Driver Complete Installation Screen

Step 16: To complete the chipset driver installation, click **FINISH**.

7.4 Intel® Graphics Media Accelerator Driver

To install the chipset driver, please follow the steps below:

Step 1: Select the VGA driver from the list in **Figure 7-2**.

Step 2: A new window opens. See **Figure 7-10**.

IMB-Q354 uATX Motherboard

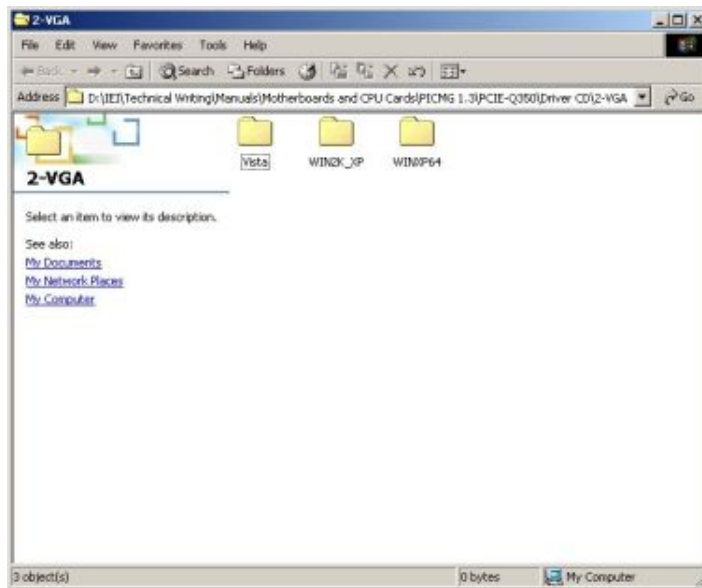

Figure 7-10: Select the Operating System

Step 3: Select the operating system from those shown in **Figure 7-10**.

Step 4: A new window appears. See **Figure 7-11**.

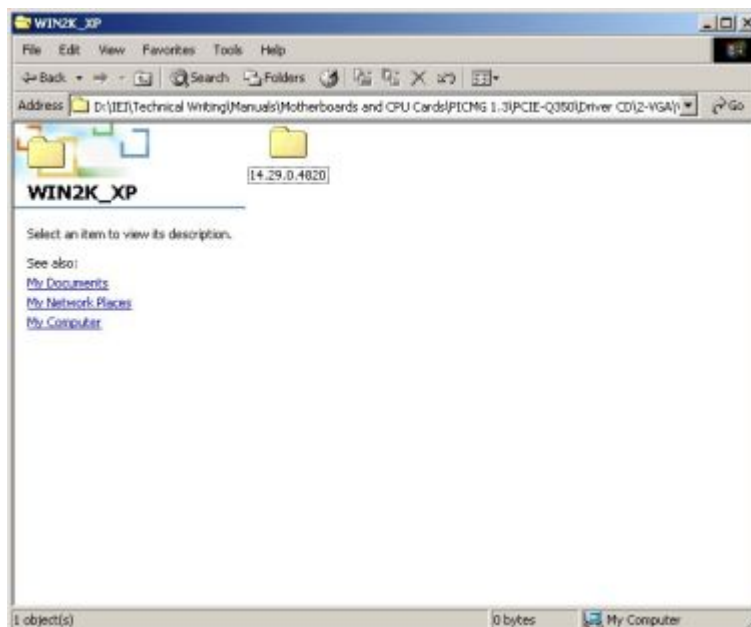

Figure 7-11: Intel® Driver Directory

Step 5: Click the directory icon in **Figure 7-11**.

Step 6: A new window appears. See **Figure 7-12**.

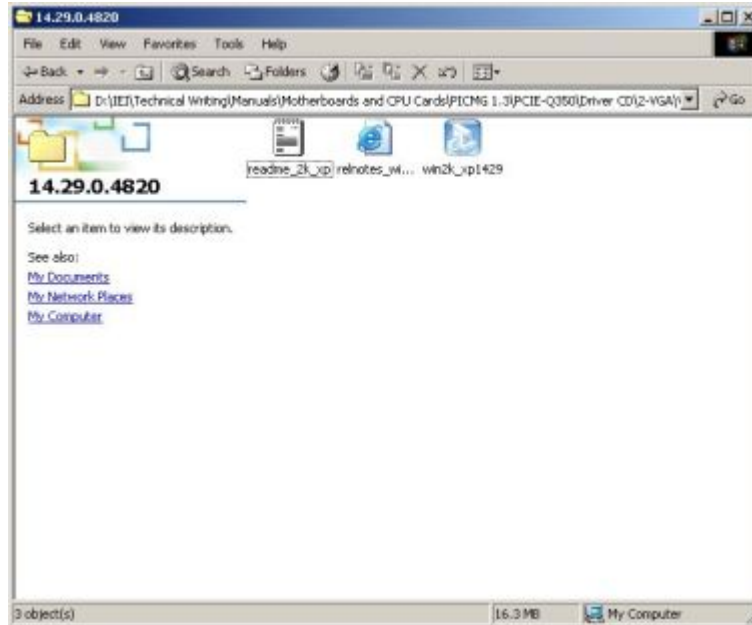

Figure 7-12: Intel® VGA Driver Setup Icon

Step 7: Click on the VGA driver installation icon in See **Figure 7-12**.

Step 8: The Readme information file shown in **Figure 7-13** appears.

IMB-Q354 uATX Motherboard



Figure 7-13: GMA Driver Readme File

Step 9: Click **NEXT** to extract the GMA driver files. See **Figure 7-14**.

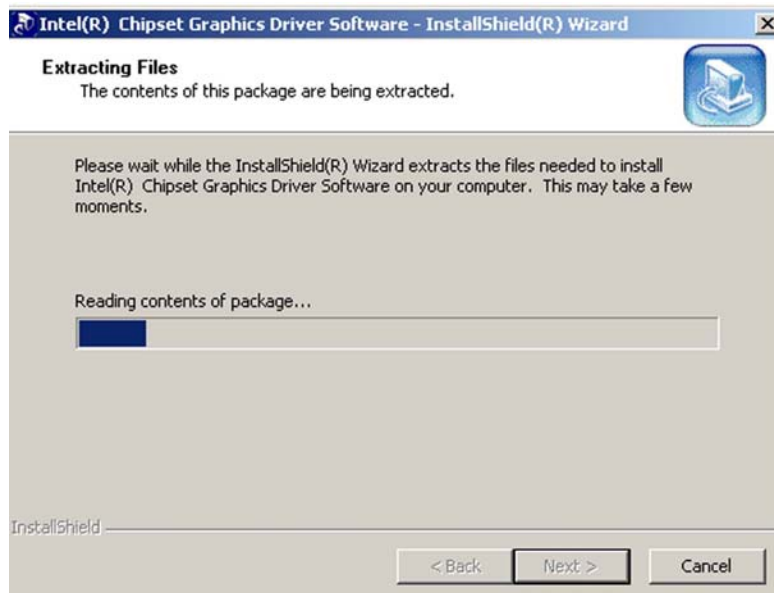

Figure 7-14: GMA Driver File Extraction

Step 10: The welcome screen shown in **Figure 7-15** appears.

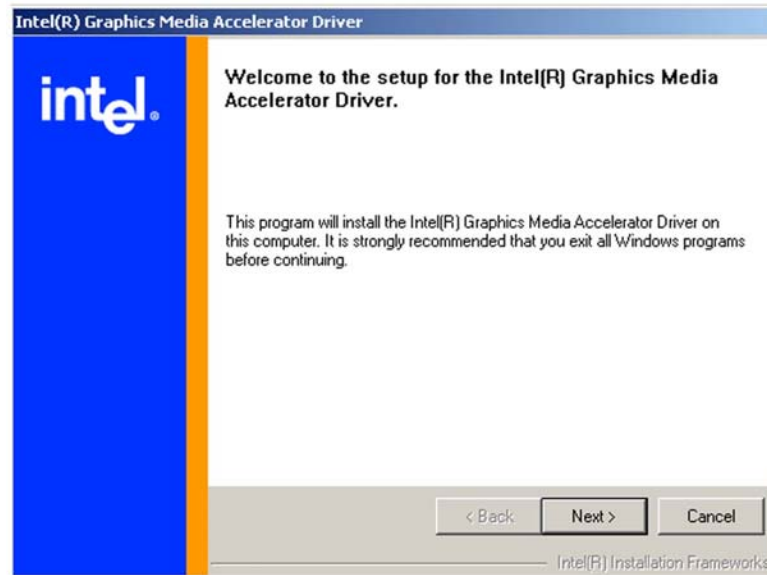

Figure 7-15: GMA Driver Installation Welcome Screen

Step 11: To continue the installation process, click **NEXT**.

Step 12: The license agreement in **Figure 7-16** appears.

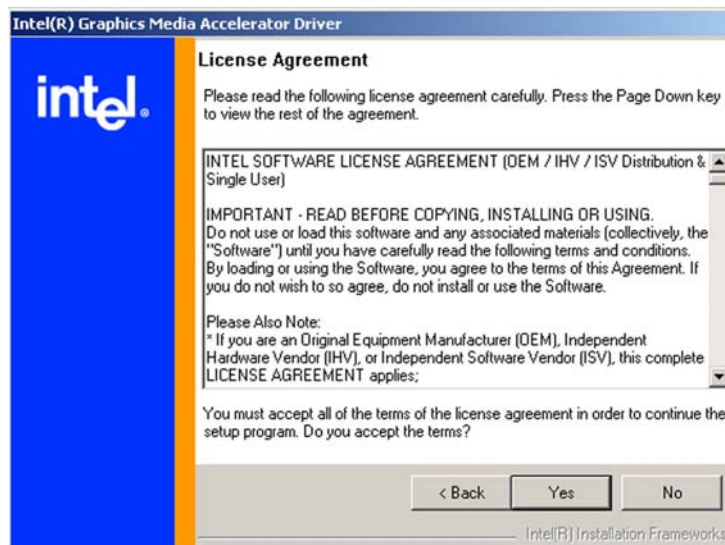

Figure 7-16: GMA Driver License Agreement

Step 13: Click the **YES** in **Figure 7-16** to continue.

IMB-Q354 uATX Motherboard

Step 14: The installation notice shown in **Figure 7-17** appears.



Figure 7-17: GMA Driver Installing Notice

Step 15: A confirmation screen shown in **Figure 7-18** appears.

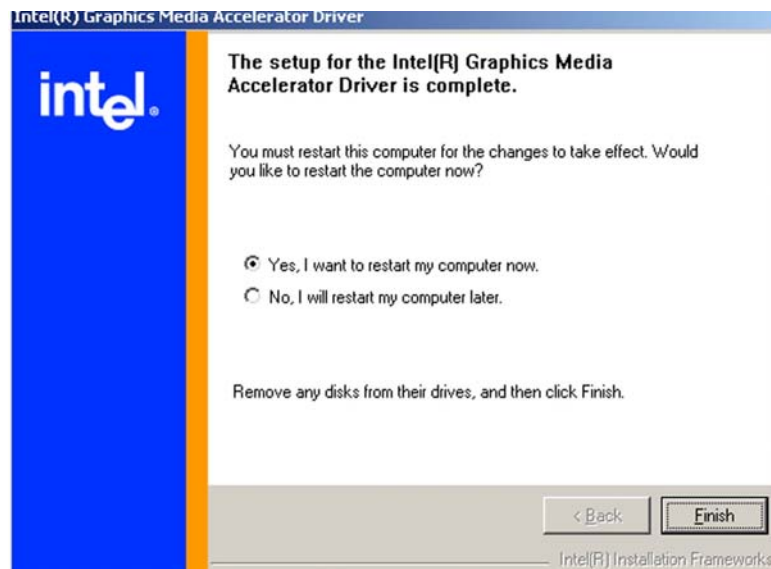

Figure 7-18: GMA Driver Installation Complete

Step 16: After selecting when to restart the computer in **Figure 7-18**, click **FINISH**.

7.5 Intel® 82566DM Gigabit LAN Connect Device Driver

To install the Intel® 82566DM Gigabit LAN connect device driver, please follow the steps below.

Step 1: Select **LAN** from the list in **Figure 7-2**.

Step 2: The window in **Figure 7-19** appears.

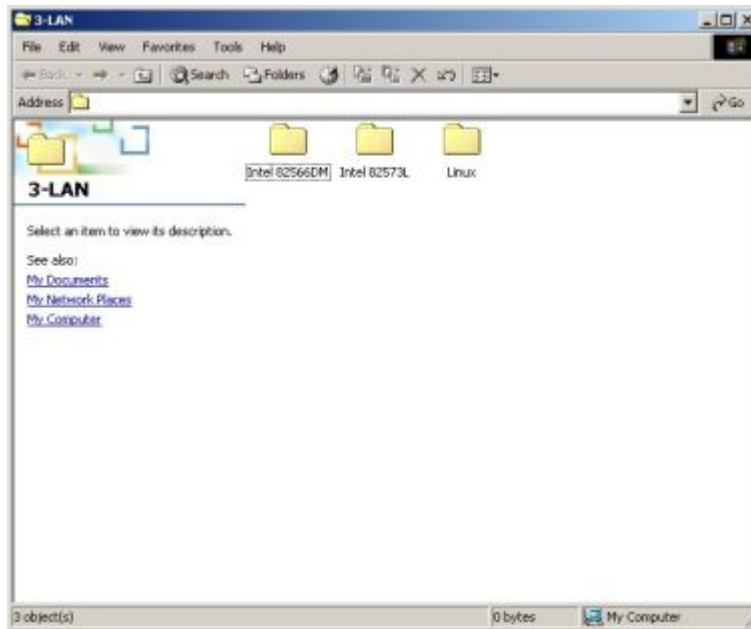

Figure 7-19: Intel® 82566DM Driver Directory Icon

Step 3: Click on the **Intel® 82566DM** directory icon in **Figure 7-19**.

Step 4: The window in **Figure 7-20** appears.

IMB-Q354 uATX Motherboard

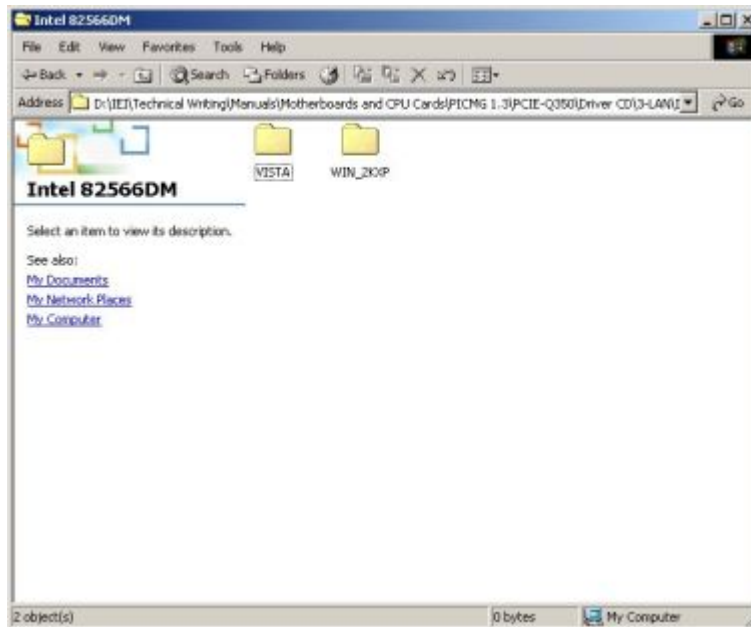

Figure 7-20: Intel® 82566DM Operating System

- Step 5:** Select the Operating System in **Figure 7-20**.
- Step 6:** The window in **Figure 7-21** appears.
- Step 7:** In **Figure 7-21** select the operating system type installed on the system.

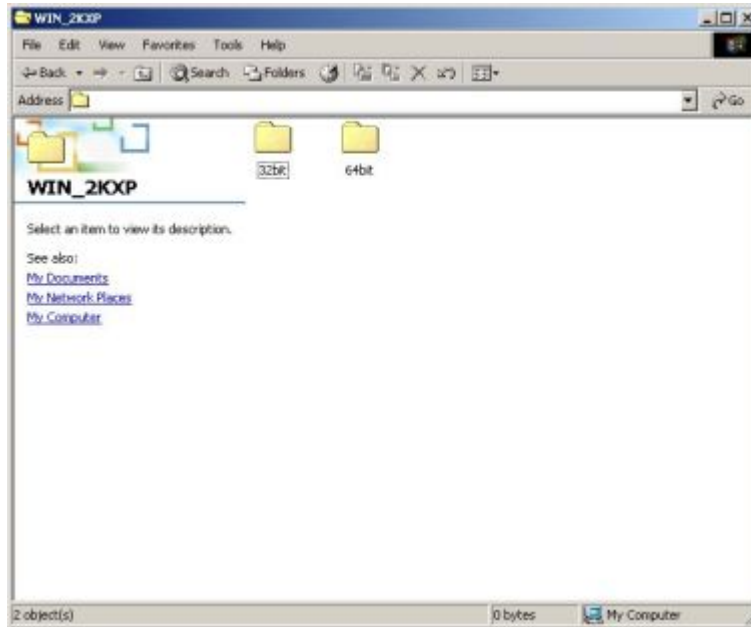

Figure 7-21: Select Operating System Type

Step 8: The window in **Figure 7-22** appears.

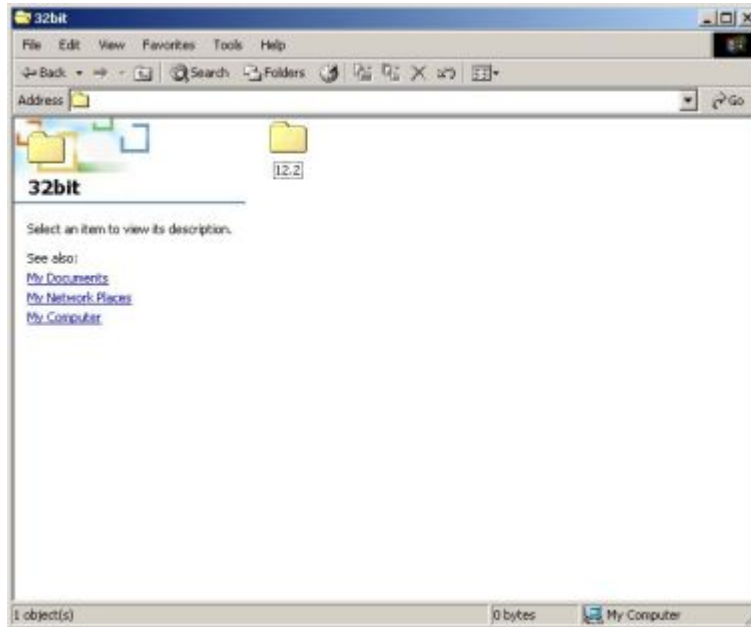

Figure 7-22: Driver Directory

Step 9: Click on the directory icon in **Figure 7-22**.

IMB-Q354 uATX Motherboard

Step 10: A window containing the Intel® 82566DM driver startup icon appears. See

Figure 7-23.

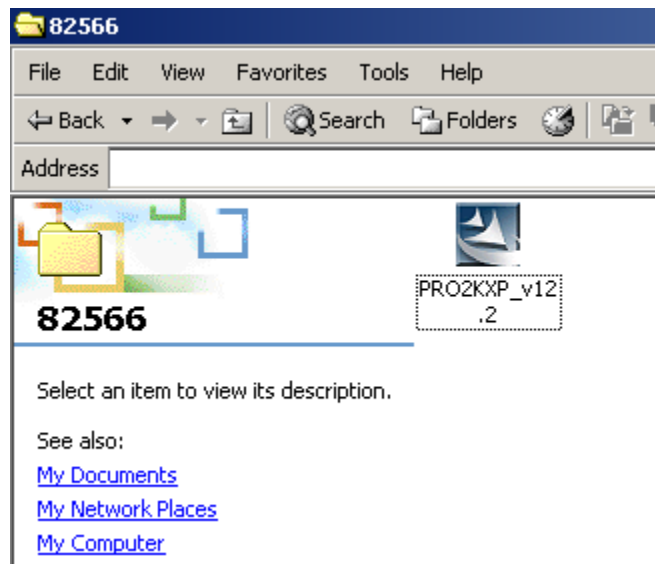

Figure 7-23: Intel® 82566DM Device Driver Startup Icon

Step 11: Double click the Intel® 82566DM driver startup icon in **Figure 7-23**.

Step 12: The driver begins to extract the installation files.

Step 13: The **Welcome** screen in **Figure 7-24** appears next.

Step 14: Click **NEXT** to continue.



Figure 7-24: Intel® 82566DM Welcome Screen

Step 15: The license agreement in **Figure 7-25** appears.



Figure 7-25: Intel® 82566DM Driver License Agreement

Step 16: Accept the conditions of the license agreement and click **NEXT** to continue.

Step 17: The **Setup Options** screen in **Figure 7-26** appears next.

IMB-Q354 uATX Motherboard

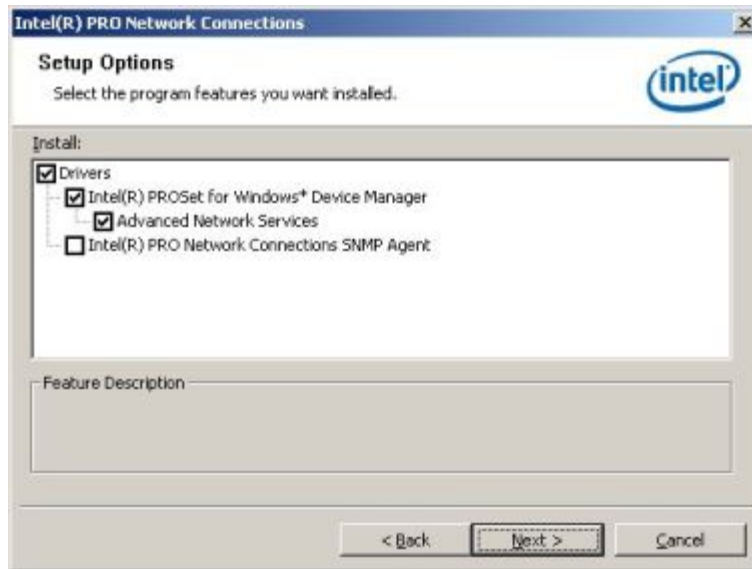

Figure 7-26: Intel® 82566DM Driver Setup Options

Step 18: Select the required installation configuration in **Figure 7-26** and click **NEXT** to continue.

Step 19: The **Ready to Install the Program** window in **Figure 7-27** appears.

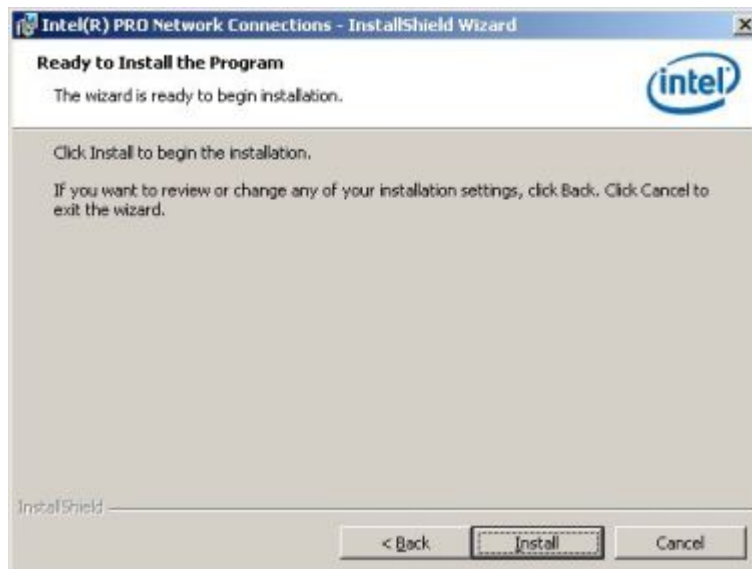

Figure 7-27: Intel® 82566DM Driver Installation Ready Window

Step 20: Click **INSTALL** in **Figure 7-27**.

Step 21: The program starts to install the driver. The window in appears.

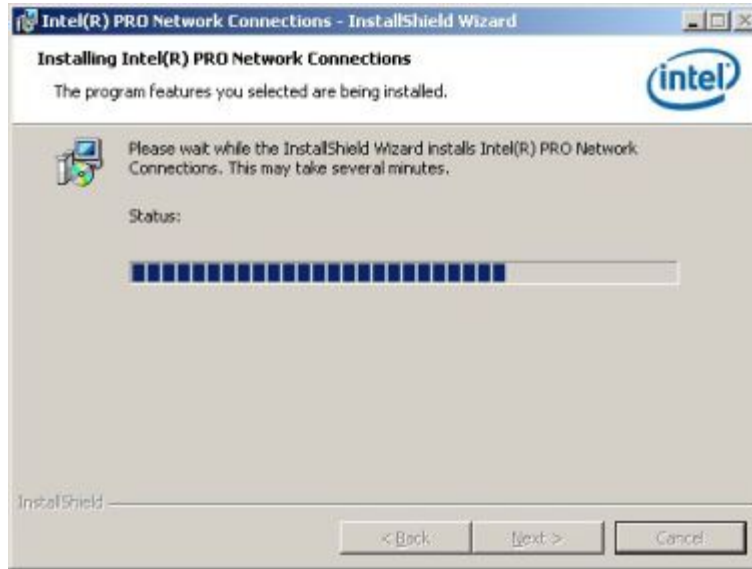

Figure 7-28: Intel® 82566DM Driver Installation Progress

Step 22: When the installation is finished. Click **FINISH** in the termination screen.

7.6 Intel® 82573 PCI Express Gigabit Ethernet Controller Driver

To install the Intel® 82573 PCIe GbE controller, please follow the steps below.

Step 1: Select **LAN** from the list in **Figure 7-2**.

Step 2: The window in **Figure 7-29** appears.

IMB-Q354 uATX Motherboard

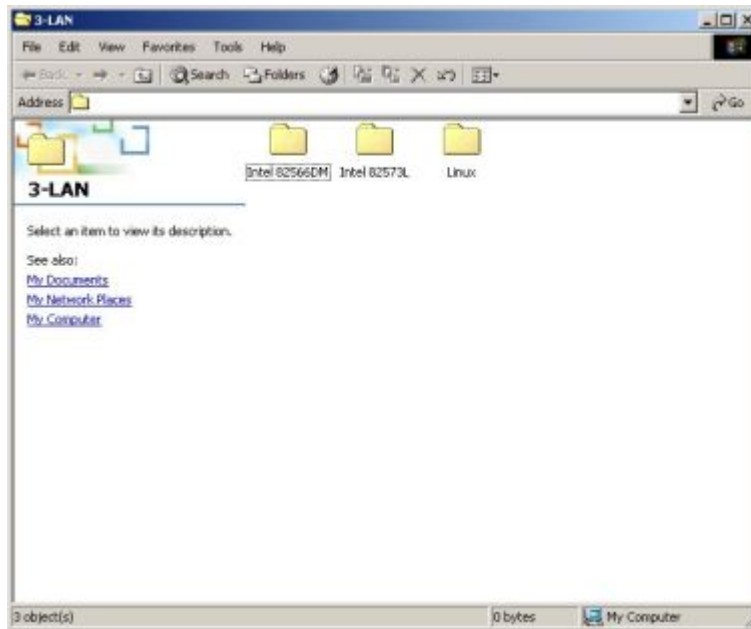

Figure 7-29: Intel® 82573 Driver Directory Icon

Step 3: Click on the **Intel® 82573L** directory icon in **Figure 7-29**.

Step 4: The window in **Figure 7-30** appears.

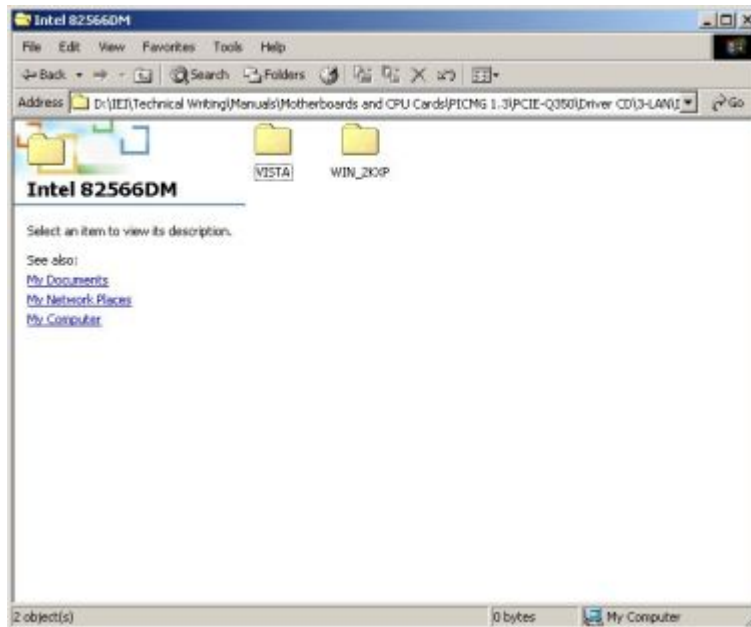

Figure 7-30: Intel® 82573 Operating System

- Step 5:** Select the Operating System in **Figure 7-30**.
- Step 6:** The window in **Figure 7-31** appears.
- Step 7:** In **Figure 7-31** select the operating system type installed on the system.

IMB-Q354 uATX Motherboard

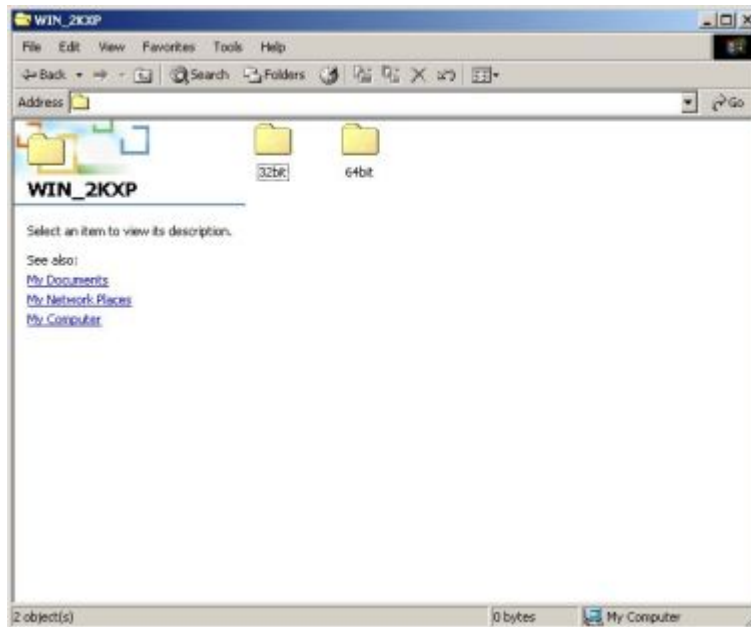

Figure 7-31: Select Operating System Type

Step 8: The window in **Figure 7-32** appears.

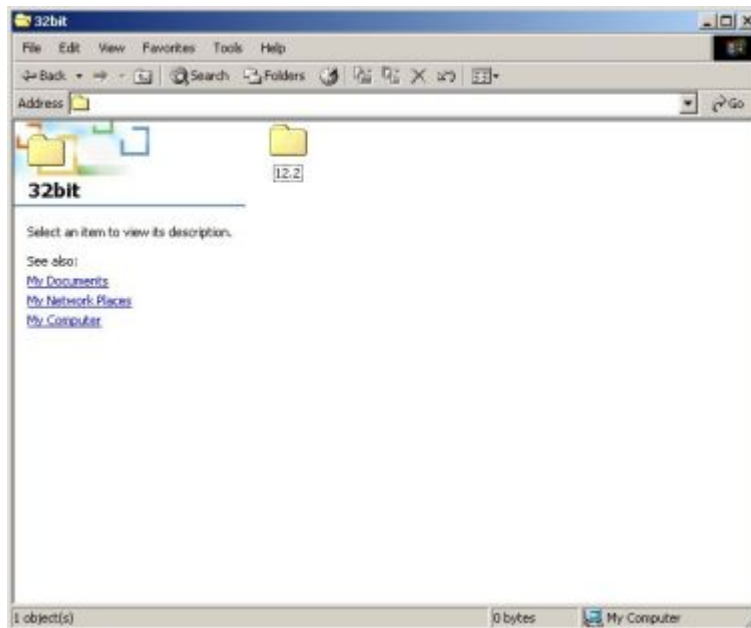

Figure 7-32: Driver Directory

Step 9: Click on the directory icon in **Figure 7-22**.

Step 10: A window containing the Intel® 82573 driver startup icon appears. See **Figure 7-32**.

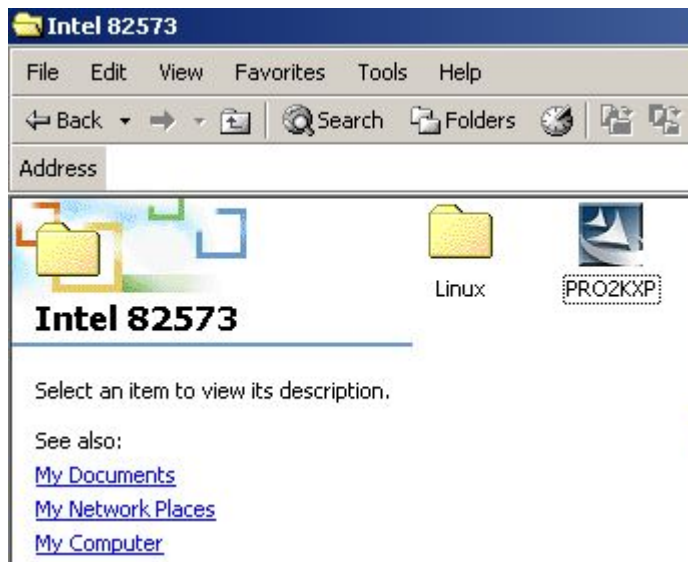

Figure 7-33: Intel® 82573 Driver Startup Icon

Step 11: Click the startup icon in **Figure 7-33**.

Step 12: The **License Agreement** for the Intel® 82573 appears. See **Figure 7-34**.

IMB-Q354 uATX Motherboard



Figure 7-34: Intel® 82573 License Agreement

Step 13: Accept the license terms and agreements in and click **NEXT** to continue.

Step 14: Next, select the directory in which the files must be saved. See **Figure 7-35**.



Figure 7-35: Intel® 82573 File Location Select

Step 15: Click **NEXT** to continue.

Step 16: The driver begins to extract the installation files. See **Figure 7-36**.



Figure 7-36: Intel® 82573 Installation Files Extraction

Step 17: The Intel® PRO Network Connections window appears. See **Figure 7-37**.

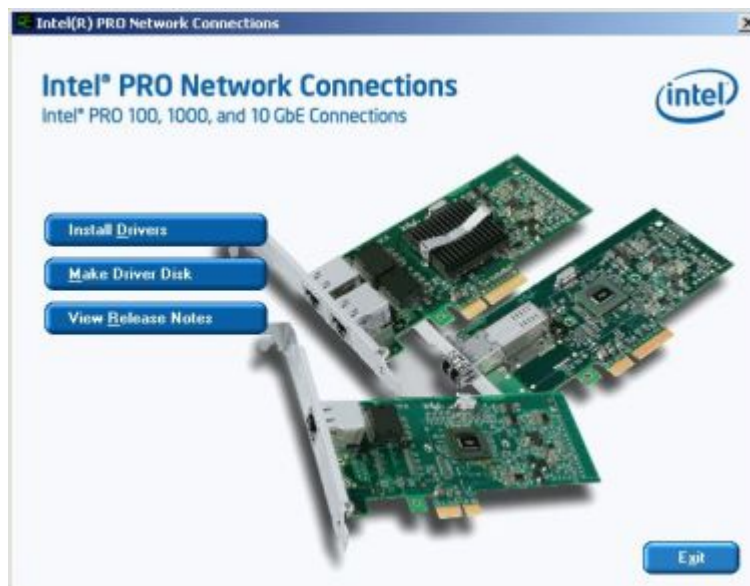

Figure 7-37: Intel® PRO Network Connections window

Step 18: Click **INSTALL DRIVERS** in **Figure 7-37**.

IMB-Q354 uATX Motherboard

Step 19: The Intel® PRO Network Connections Welcome screen in **Figure 7-38** appears.



Figure 7-38: Intel® PRO Network Connections Welcome

Step 20: Click **NEXT** to continue.

Step 21: A new **License Agreement** appears. See **Figure 7-39**.



Figure 7-39: License Agreement

Step 22: Accept the terms and conditions in **Figure 7-39** and click **NEXT** to continue.

Step 23: The **Setup Type** window in **Figure 7-40** appears.



Figure 7-40: Setup Type

Step 24: Select the setup type in **Figure 7-40** and click **NEXT** to continue.

Step 25: The drivers are installed. See **Figure 7-41**.

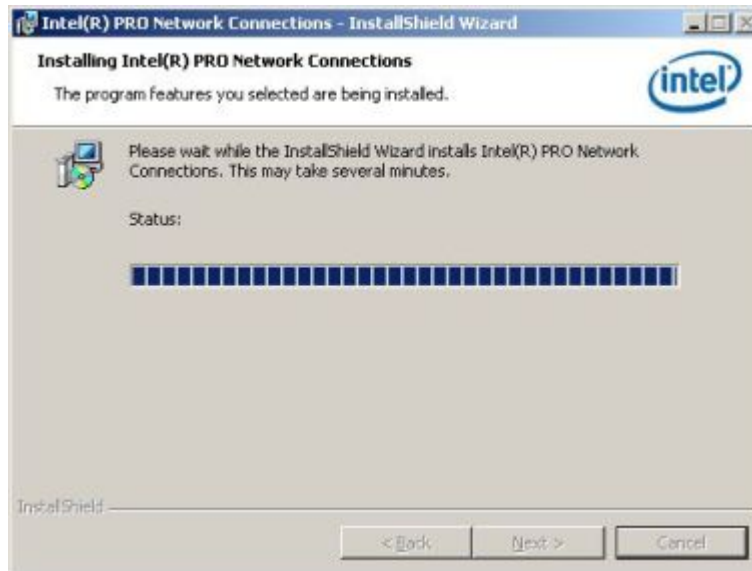

Figure 7-41: Intel® 82573 Driver Installation Progress

Step 26: When the driver is installed. Click **FINISH** in the termination screen.

7.7 Realtek HD Audio Driver (ALC883) Installation

To install the Realtek High Definition (HD) Audio driver, please follow the steps below.



NOTE:

This driver only needs to be installed if an external audio kit with a RealTek ALC883 codec is installed.

7.7.1 BIOS Setup

Step 1: Enter the BIOS setup. To do this, reboot the system and press **DEL** during POST.

Step 2: Go to the Southbridge Configuration menu. Enable the High Definition Audio controller.

Step 3: Press **F10** to save the changes and exit the BIOS setup. The system reboots.

7.7.2 Driver Installation

To install the audio driver please follow the steps below.

Step 1: Select **AUDIO** from the list in **Figure 7-2**.

Step 2: A new window opens (**Figure 7-42**).

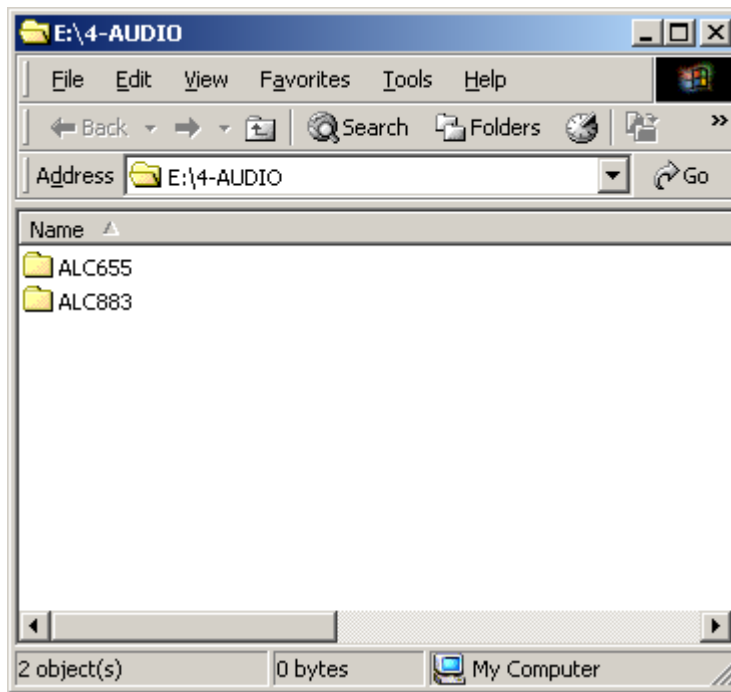

Figure 7-42: Select the Audio CODEC

Step 3: Double-click the ALC883 folder.

Step 4: Double-click the appropriate operating system folder (**Figure 7-43**).

IMB-Q354 uATX Motherboard

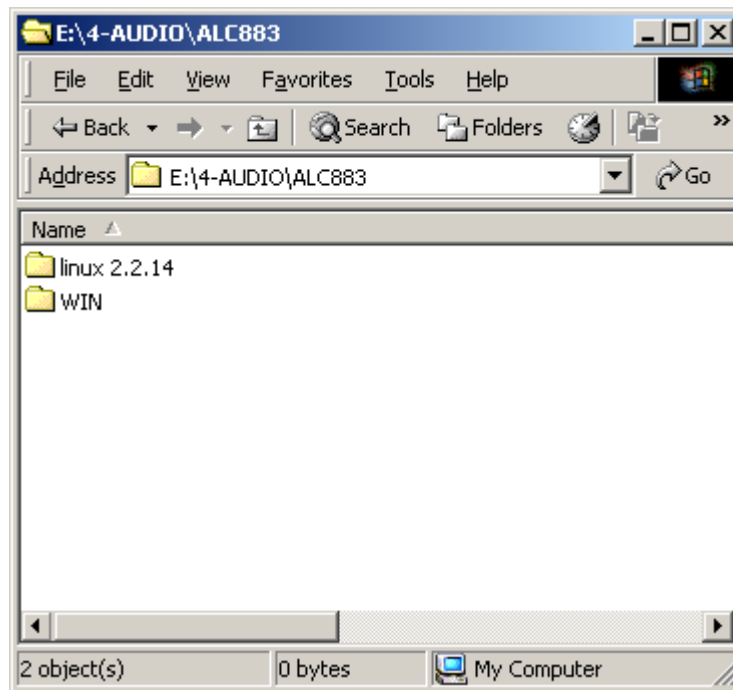

Figure 7-43: Select the OS

Step 5: Double-click the appropriate operating system version folder (Figure 7-44).

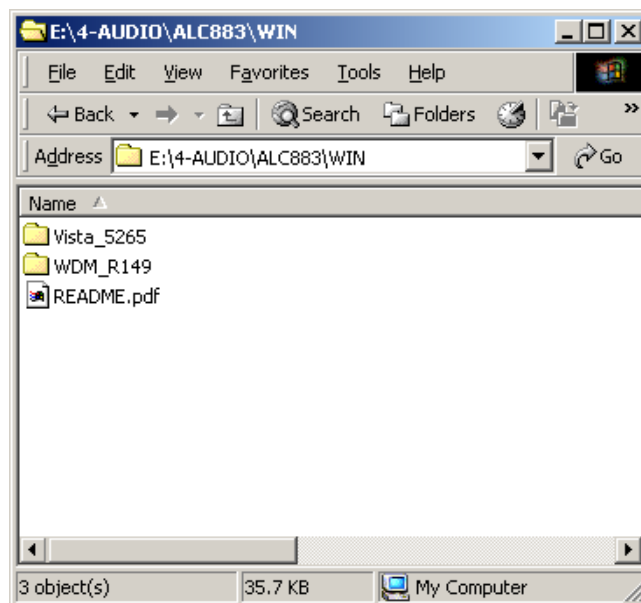

Figure 7-44: Select the OS Version

Step 6: Double-click the **Setup.exe** program icon in Figure 7-45.

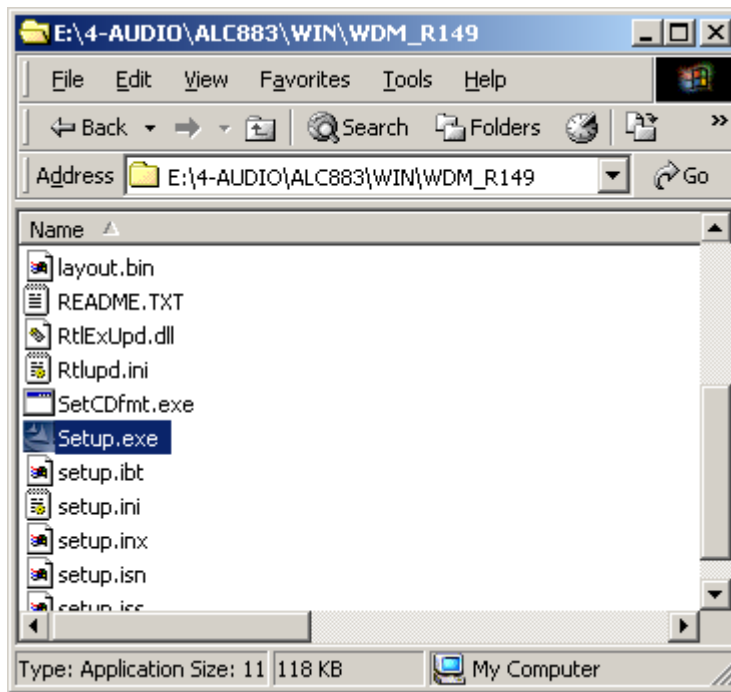

Figure 7-45: Locate the Setup Program Icon

Step 7: The InstallShield Wizard starts (Figure 7-46).

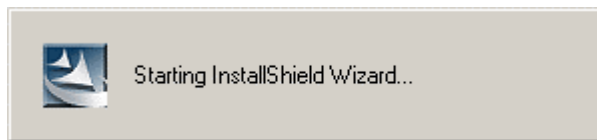

Figure 7-46: The InstallShield Wizard Starts

Step 8: The InstallShield Wizard is prepared to guide the user through the rest of the process (Figure 7-47).

IMB-Q354 uATX Motherboard

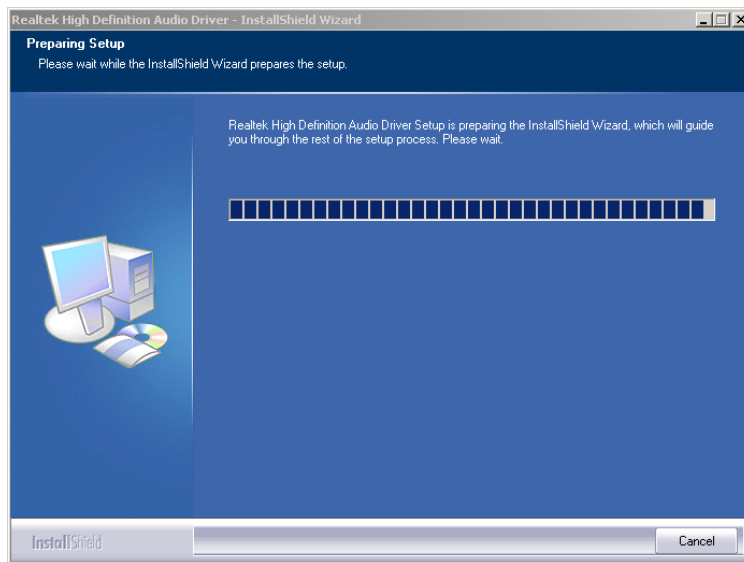

Figure 7-47: Preparing Setup Screen

Step 9: Once initialized, the **InstallShield Wizard** welcome screen appears (Figure 7-48).

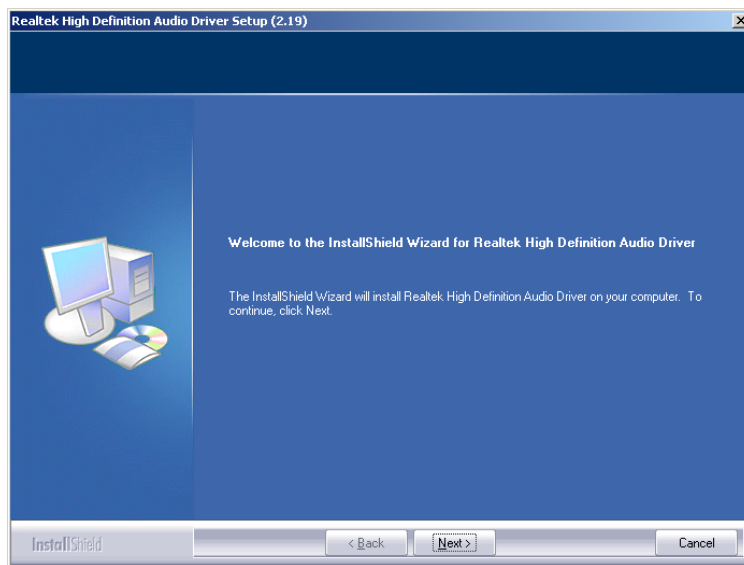

Figure 7-48: InstallShield Wizard Welcome Screen

Step 10: Click **NEXT** to continue the installation.

Step 11: InstallShield starts to install the new software as shown in **Figure 7-49**.

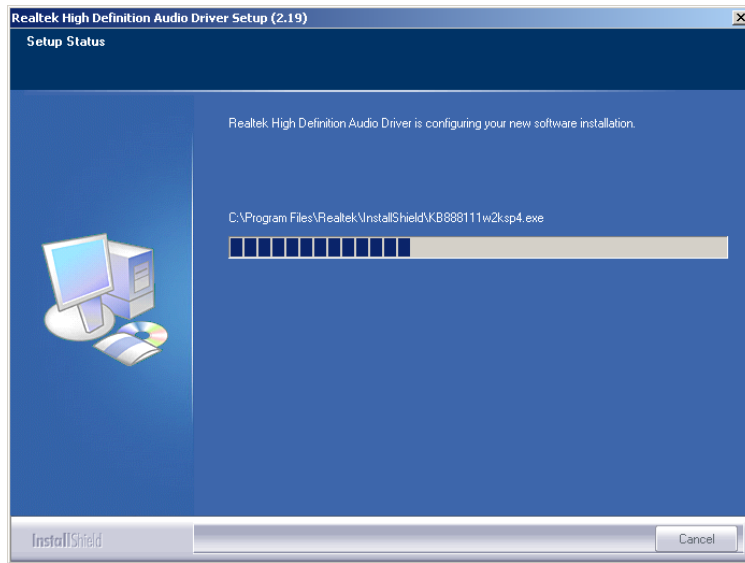

Figure 7-49: Audio Driver Software Configuration

Step 12: The Installation Wizard updates the system as shown in **Figure 7-50**.

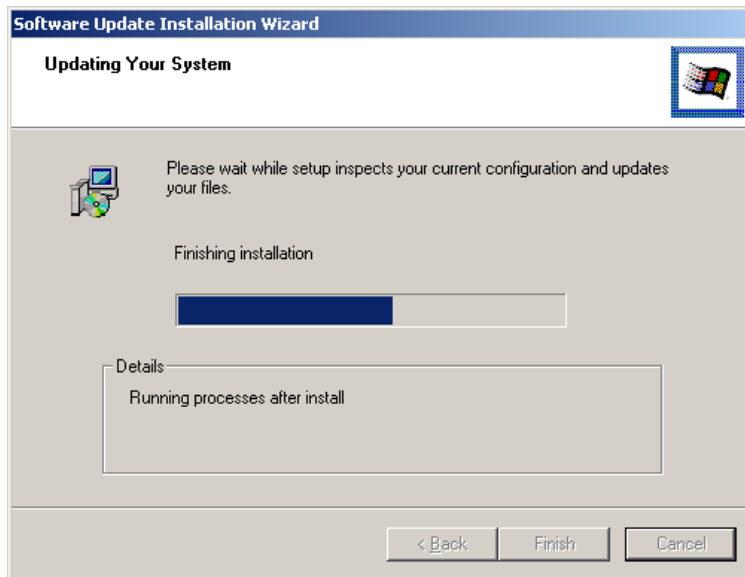

Figure 7-50: Installation Wizard Updates the System

Step 13: After the driver installation process is complete, a confirmation screen appears (Figure 7-51).

IMB-Q354 uATX Motherboard

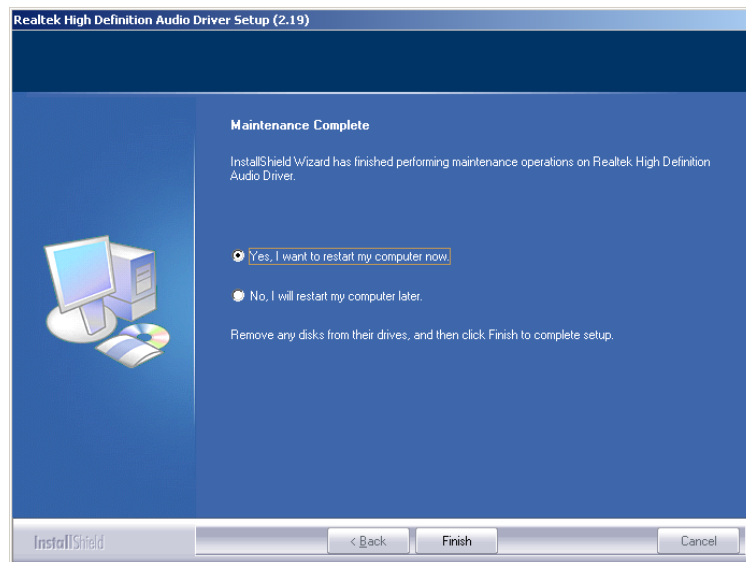

Figure 7-51: Restart the Computer

Step 14: The confirmation screen offers the option of restarting the computer now or later.

For the settings to take effect, the computer must be restarted. Click **FINISH** to restart the computer.

7.8 Intel® Matrix Storage Manager Driver Installation

To install the Intel® Matrix Storage Manager driver, please follow the steps below:

Step 1: Select **SATA** from the list in **Figure 7-2**.

Step 2: A new window opens (**Figure 7-52**).

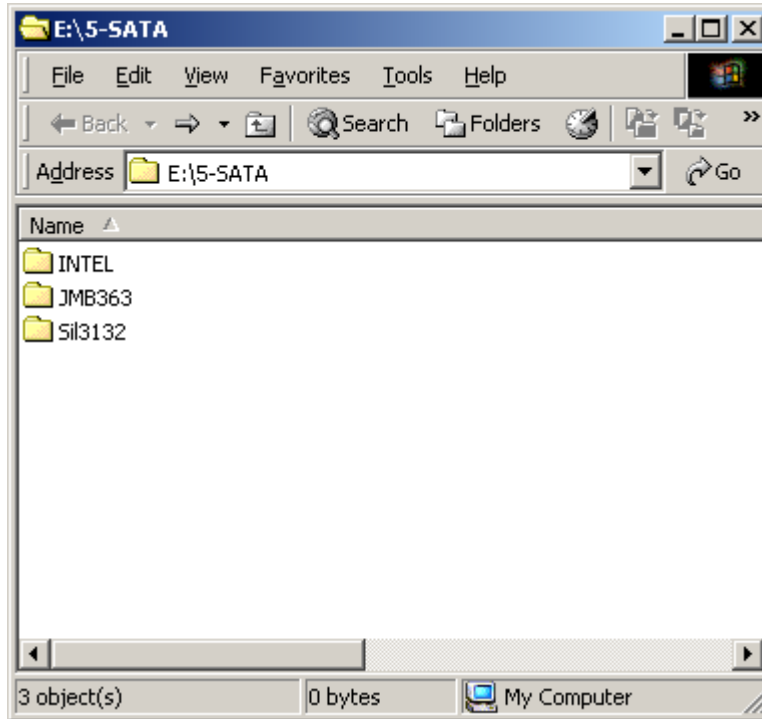

Figure 7-52: SATA RAID Driver Installation Program

Step 3: Double-click the **INTEL®** folder.

Step 4: Double-click the **iata62_cd.exe** program icon in **Figure 7-53**.

IMB-Q354 uATX Motherboard

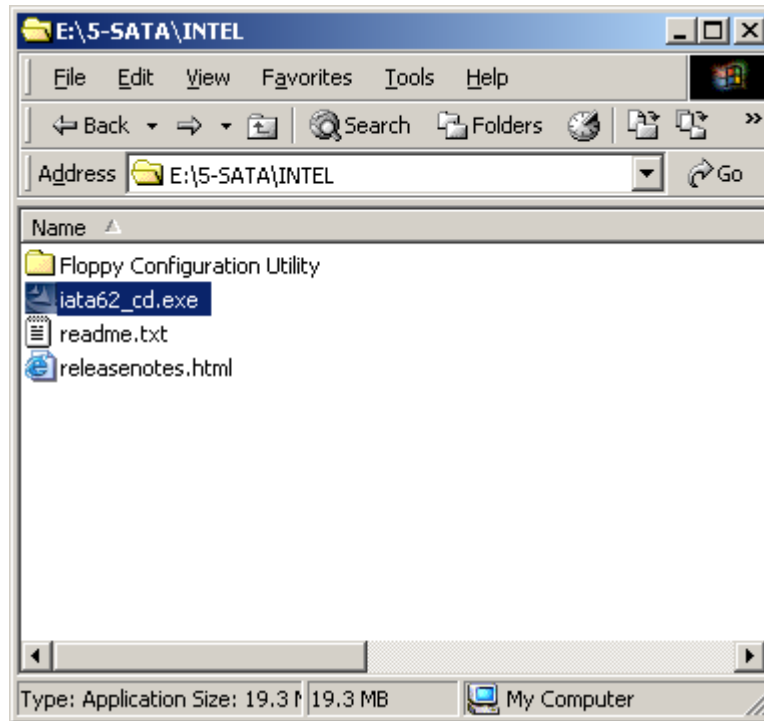

Figure 7-53: SATA RAID Setup Program Icon

Step 5: Figure 7-54 shows the InstallShield Wizard preparing to guide the user through the rest of the process.

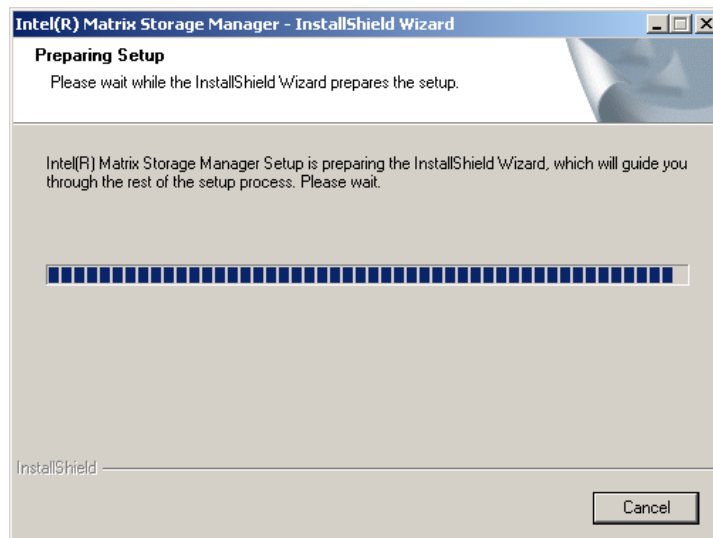

Figure 7-54: InstallShield Wizard Setup Screen

Step 6: Figure 7-55 shows the **Matrix Storage Manager** software configuring the installation process.

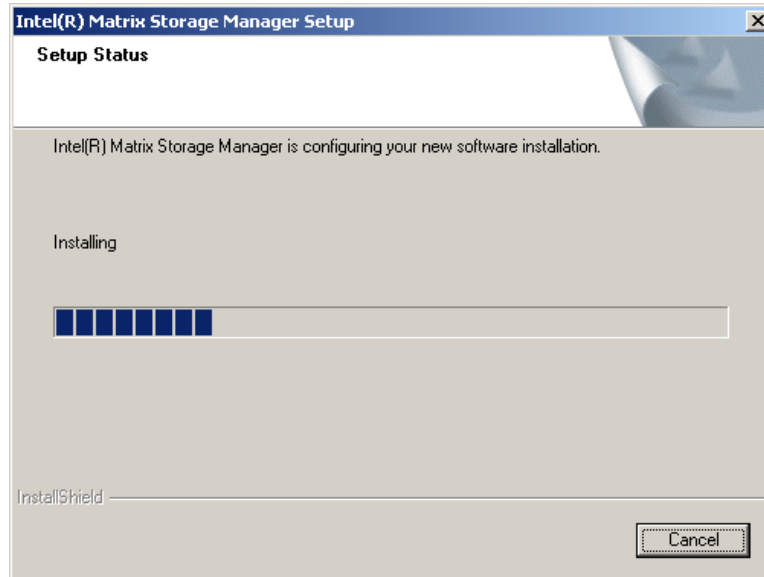

Figure 7-55: Matrix Storage Manager Setup Screen

Step 7: Figure 7-56 shows the **Matrix Storage Manager** welcome screen.

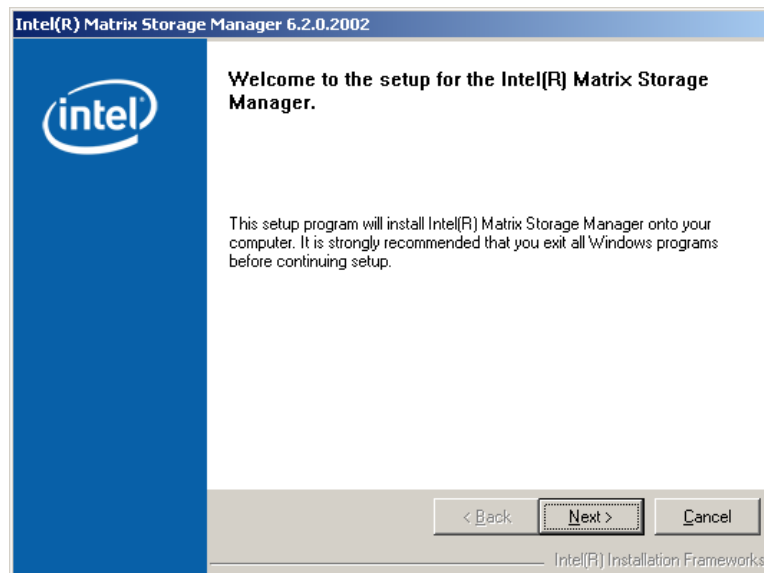

Figure 7-56: Matrix Storage Manager Welcome Screen

Step 8: Click **NEXT** and a warning appears (**Figure 7-57**). Read the warning carefully

and decide whether or not to continue the installation process.

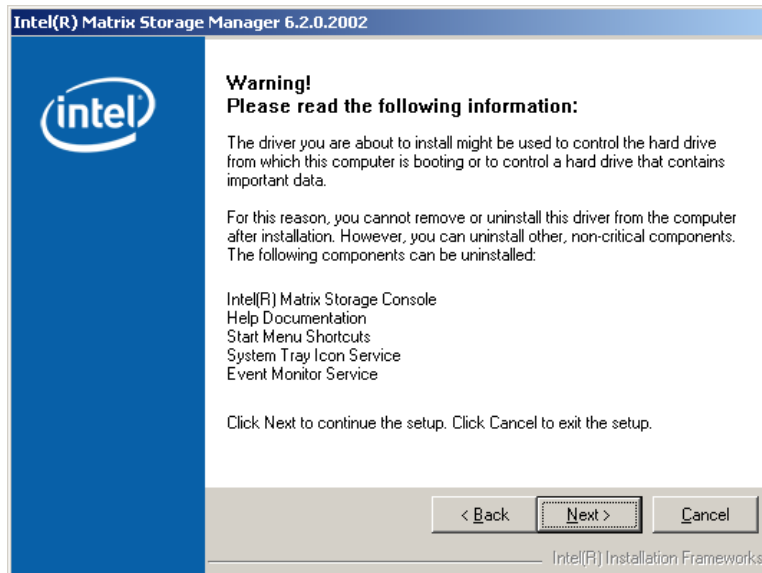

Figure 7-57: Matrix Storage Manager Warning Screen

Step 9: Click **NEXT** and a license agreement appears (**Figure 7-58**).

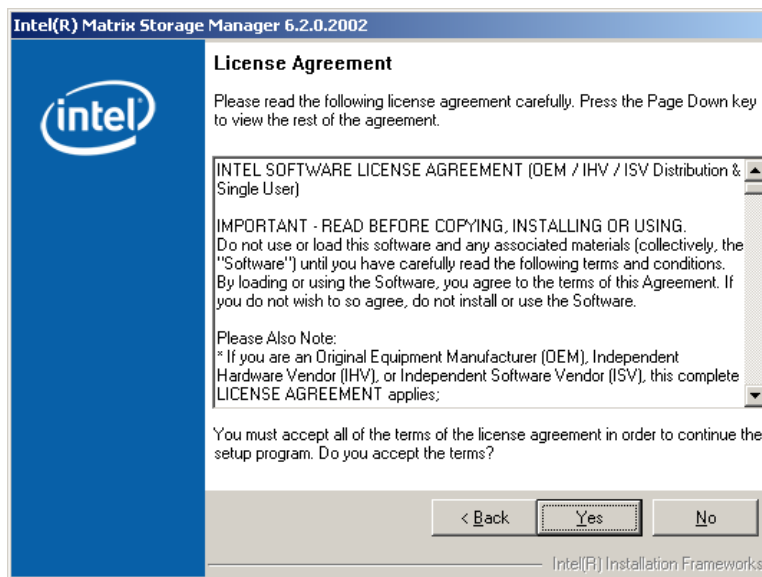

Figure 7-58: Matrix Storage Manager License Agreement

Step 10: Read the license agreement. To accept the terms and conditions stipulated in the license agreement shown, click **YES** and the Readme information file shown in **Figure 7-59** appears.

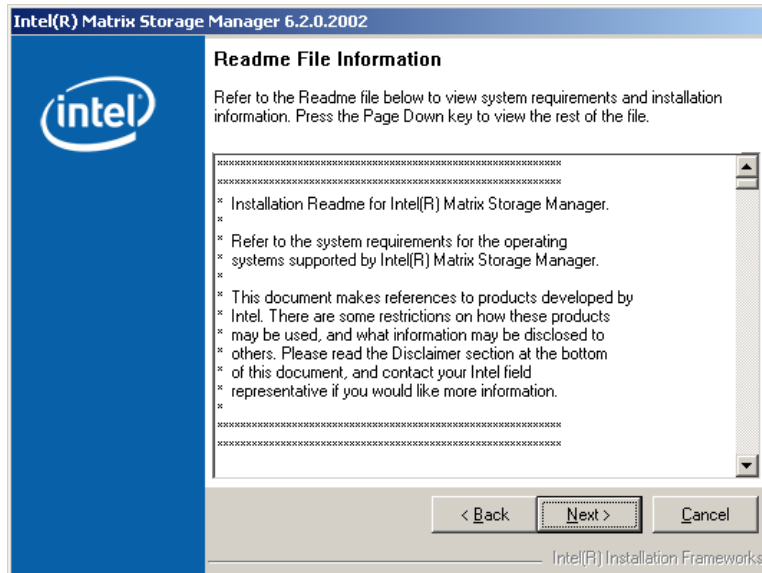

Figure 7-59: Matrix Storage Manager Readme File

Step 11: Read the Readme file information and click **NEXT**.

Step 12: After the driver installation process is complete, a confirmation screen appears (Figure 7-60).

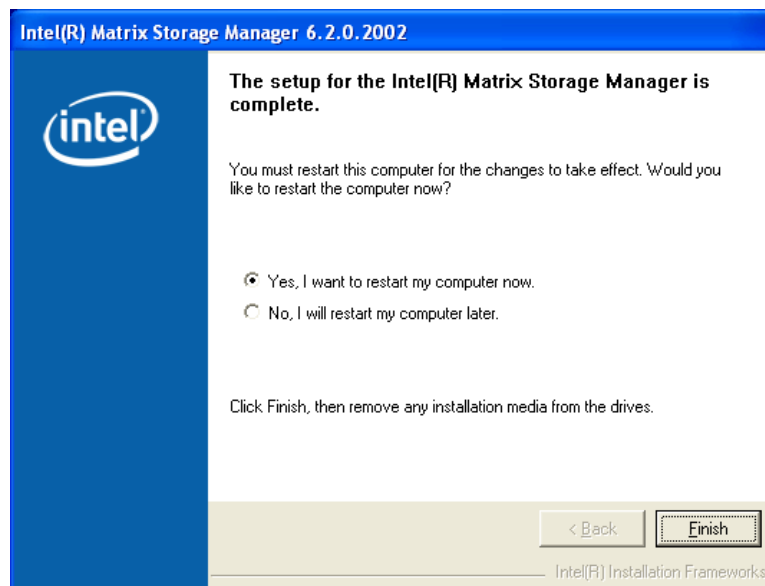

Figure 7-60: Matrix Storage Manager Setup Complete

Step 13: The confirmation screen offers the option of restarting the computer now or later.

IMB-Q354 uATX Motherboard

For the settings to take effect, the computer must be restarted. Click **FINISH** to restart the computer.

7.9 Intel® Active Management Technology Driver Installation

To install the Intel® Active Management Technology (IAMT) driver, please follow the steps below:

Step 1: Select **iAMT and Utilities** from the list in **Figure 7-2**.

Step 2: The screen in **Figure 7-61** appears.

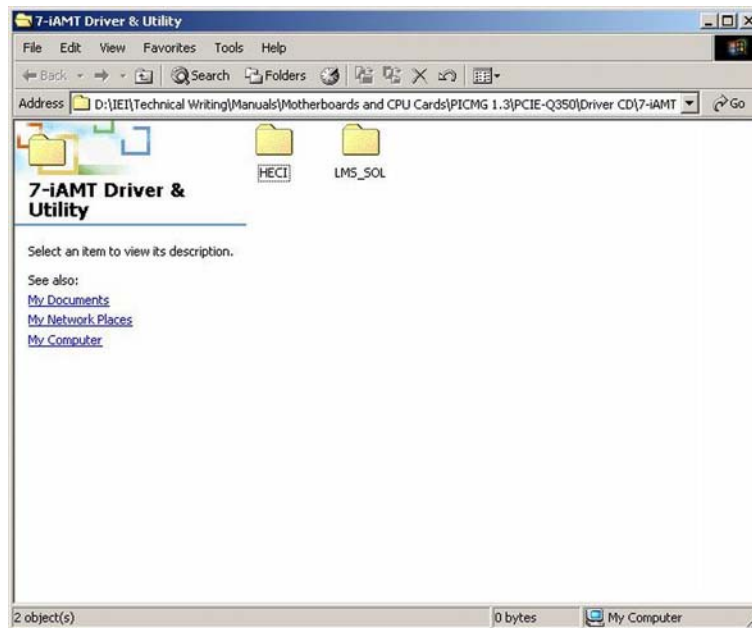

Figure 7-61: IAMT Driver Directory

Step 3: Click on the LMS_SOL directory icon. The window in **Figure 7-62** appears.

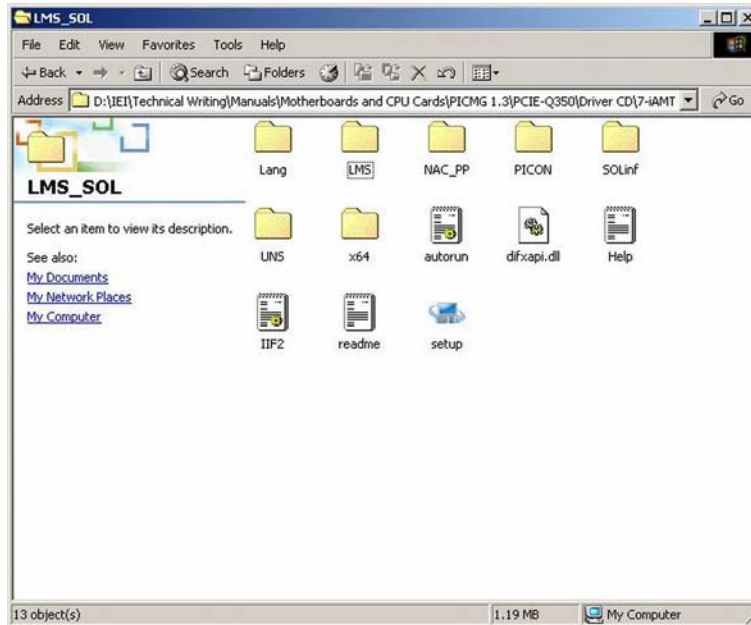

Figure 7-62: IAMT Driver Installation Icon

Step 4: Double click the setup icon in **Figure 7-62**.

Step 5: The window in **Figure 7-63** appears.



Figure 7-63: IAMT Welcome Screen

Step 6: Click **NEXT** to continue. The **License Agreement** in **Figure 7-64** appears.

IMB-Q354 uATX Motherboard



Figure 7-64: IAMT License Agreement

Step 7: Agree to the terms and conditions in the license agreement by clicking **YES**.

Step 8: The IAMT Readme file in **Figure 7-65** appears



Figure 7-65: IAMT Readme File

Step 9: Click **NEXT** to continue.

Step 10: Setup operations are performed. See **Figure 7-66**.

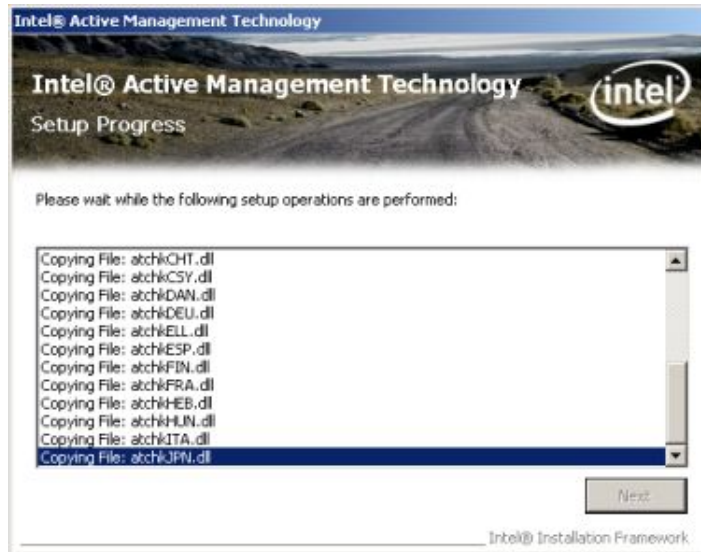

Figure 7-66: IAMT Setup Operations

Step 11: When the Setup Operations in **Figure 7-66** are complete, the window in **Figure 7-67** appears.



Figure 7-67: Completed Installation

Step 12: Click **FINISH** to complete the IAMT installation.

Step 13: Go back to **iAMT and Utilities** directory (**Figure 7-68**).

IMB-Q354 uATX Motherboard

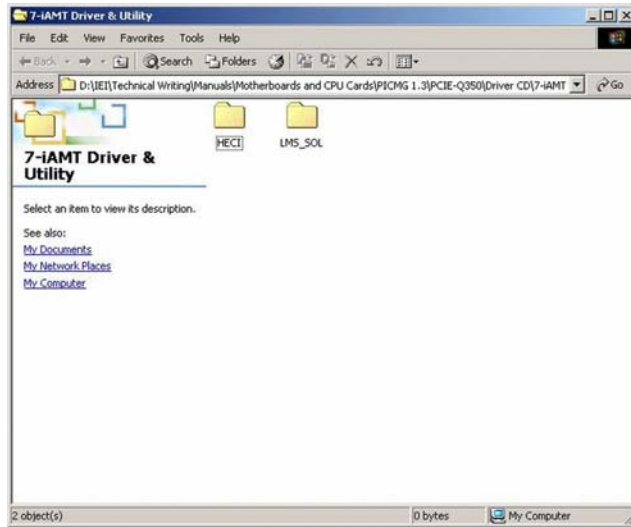

Figure 7-68: IAMT Driver Directory

Step 14: Click on the HECI directory icon. The window in **Figure 7-69** appears.

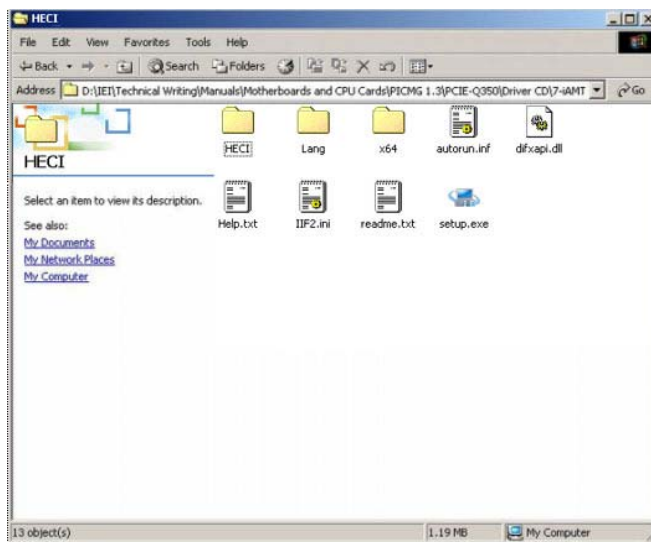

Figure 7-69: HECI Driver Installation Icon

Step 15: Double click the setup icon in **Figure 7-69**.

Step 16: Follow the step-by-step installation process to install the HECI driver.

THIS PAGE IS INTENTIONALLY LEFT BLANK

Chapter

8

Intel[®] AMT Configuration

8.1 Intel® AMT Setup Procedure

The IMB-Q354 is featured with the Intel® Active Management Technology (AMT) 3.0. To enable the Intel® AMT function, follow the steps below.

Step 1: Make sure the **DIMM1** socket is installed with one DDR2 DIMM.

Step 2: Connect an Ethernet cable to the RJ-45 connector labeled **LAN2_USB23**.

Step 3: The AMI BIOS options regarding the Intel® ME or Intel® AMT must be enabled, including:

- Intel® AMT Configuration [Advanced] (see **Section 6.3.8**)
- ME Subsystem Configuration [Advanced] (see **Section 6.3.8.1**)

Step 4: Configure the Intel® Management Engine BIOS extension (MEBx) (see **Section 8.2** below)

Step 5: Properly install the Intel® AMT drives. Make sure to install both HECI and LMS_SOL drivers from the iAMT Driver & Utility directory in the driver CD (see **Section 7.9**).

Step 6: The following dialog window is displayed after the OS is loaded to show the Intel® AMT status on the IMB-Q354 is enabled.



Figure 8-1: Intel® Active Management Technology Status Dialog

8.2 Intel® Management Engine BIOS Extension

This section describes the essential steps for using the Intel® Management Engine BIOS extension (MEBx).

Step 1: A screen prompts the user to press <Ctrl+P> after a single beep during boot-up process. To get into the Intel® MEBx settings, press <Ctrl+P>.

Step 2: Enter the Intel® current ME password as it requires (**Figure 8-2**). Enter the IEI factory ME password: **Abab12!@** (the Intel® default password is **admin**).



NOTE:

The default Intel® ME password is **admin**. The IEI has reset the password to **Abab12!@** in quality control process. After clearing the CMOS, the ME password bound to Intel® default password (admin). Use Intel® default password to enter the Intel® ME BIOS and change the password (refer to **Step 3** below) to be able to configure the Intel® AMT and ME options.



Figure 8-2: Intel® Current ME Password

Step 3: To change the password, select **Change Intel® ME Password**. Enter a new password following the strong password rule (containing at least one upper case letter, one lower case letter, one digit and one special character, and be at least eight characters). (**Figure 8-3**)

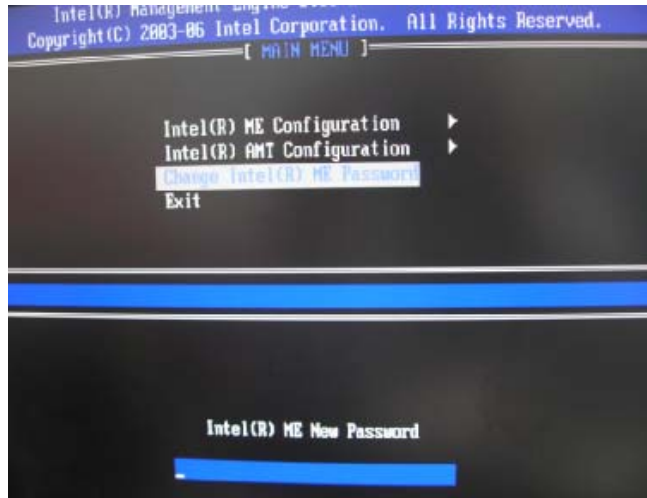

Figure 8-3: Change Intel® ME Password

Step 4: Verify the new password by entering again (**Figure 8-4**).

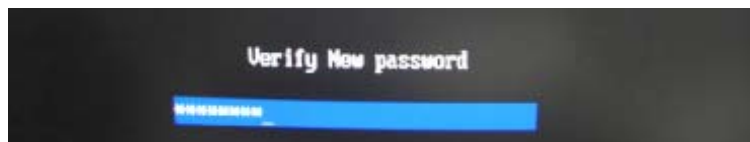

Figure 8-4: Verify New Password

Step 5: Select **Intel® AMT Configuration** and press **Enter** (**Figure 8-5**).



Figure 8-5: Intel® AMT Configuration

IMB-Q354 uATX Motherboard

Step 6: Select **Provision Model** and press **Enter**. (Figure 8-6)

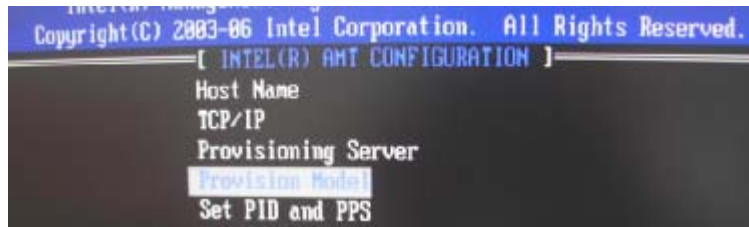

Figure 8-6: Provision Model

Step 7: When the screen in **Figure 8-7** prompts, enter **N** and press **Enter**.

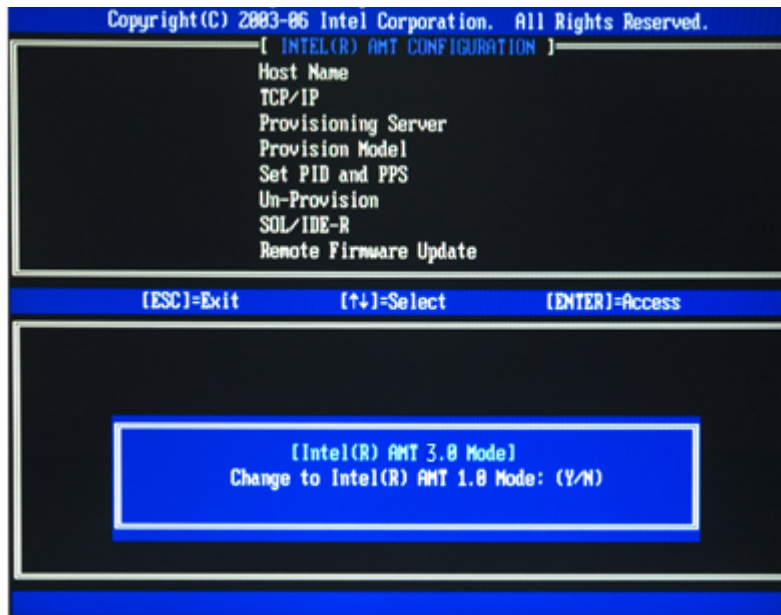

Figure 8-7: Intel® AMT 3.0 Mode

Step 8: A message prompts to confirm to Change to Small Business (Figure 8-8). Enter **Y** and press **Enter**.



Figure 8-8: Enterprise

Step 9: Select TCP/IP (in Intel AMT Configuration) and press **Enter**. A message prompts for disabling network interface. Enter **N** to enable network interface.



Figure 8-9: Enable Network Interface

IMB-Q354 uATX Motherboard

Step 10: Enable or disable DHCP. DHCP is enabled by default. If DHCP is disabled, enter the following TCP/IP settings:

- Static TCP/IP address (the static TCP/IP address and Intel® AMI Host Name must be different from those configured in the operating system)
- Subnet mask
- Default Gateway address (optional)
- Preferred Domain Naming Services (DNS) server address (optional)
- Alternate DNS server address (optional)
- Domain name (optional)

Step 11: Make other necessary settings in the Intel® MEBx depending on users' need.

Step 12: To exit the Intel® MEBx, return to the main menu and select **Exit**. (Figure 8-10)

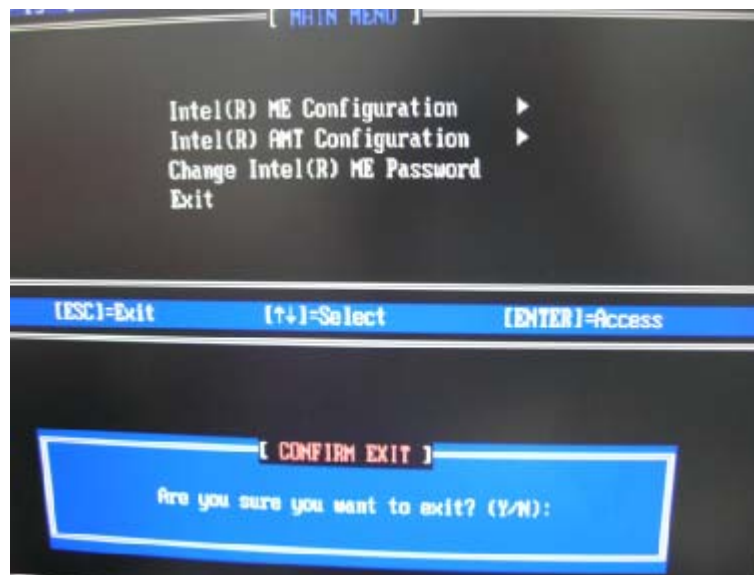

Figure 8-10: Exit

8.3 Using the Intel® AMT Web Interface



NOTE:

Prior to use the Intel® AMT web interface, please make sure the Intel® AMT drivers are properly installed in the IMB-Q354 and the Intel® AMT enabled confirmation dialog window displays after boot-up.

To access an Intel® AMT client system from a remote console, follow the steps below.

Step 1: Obtain the IP address of the client system.

Step 2: On the remote management console, open a web browser.

Step 3: If DHCP is enabled in the TCP/IP menu of the Intel® ME BIOS (**Section 8.2, Step 10**), get the client system IP address in the MS DOS. Enter the client system IP address and the port number in the web browser:

`http://ip_address:16992` Example: `http://192.168.1.7:16992` (**Figure 8-11**)

Or simply enter the defined host name: `http://host_name:16992`

Example: `http://AMTsystem:16992`



Figure 8-11: Intel® AMT Web Address

Step 4: If a static IP address is defined for the Intel® AMT client system, enter the defined client system IP address and the port number in the web browser.

Step 5: A login window prompts (**Figure 8-12**).

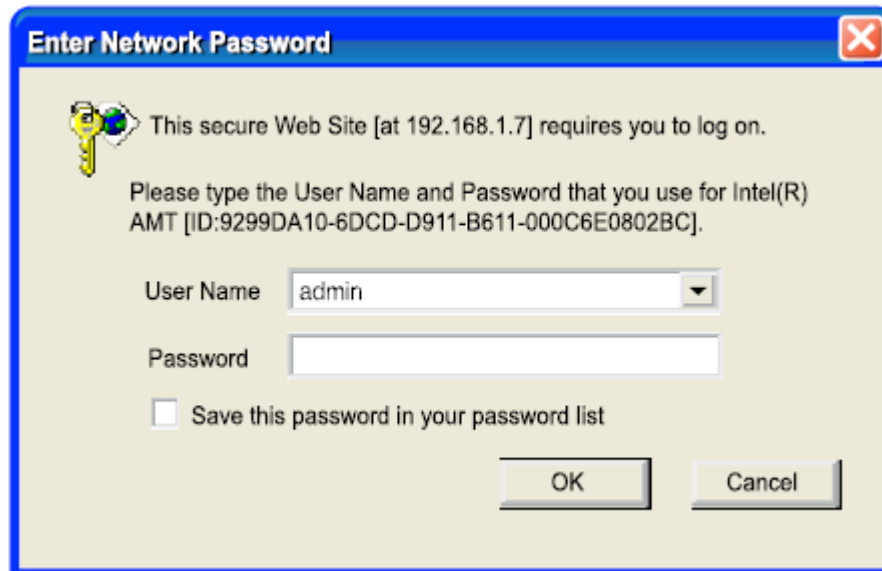

Figure 8-12: Intel® AMT Web Login Dialog

- Step 6:** Enter **admin** as the user name (**Figure 8-12**).
- Step 7:** Enter the password changed in the Intel® MEBx configuration (**Section 8.2, Step 3**). If the password remained as default, enter Abab12!@
- Step 8:** Press **OK** and the Intel® AMT web interface appears (**Figure 8-13**).

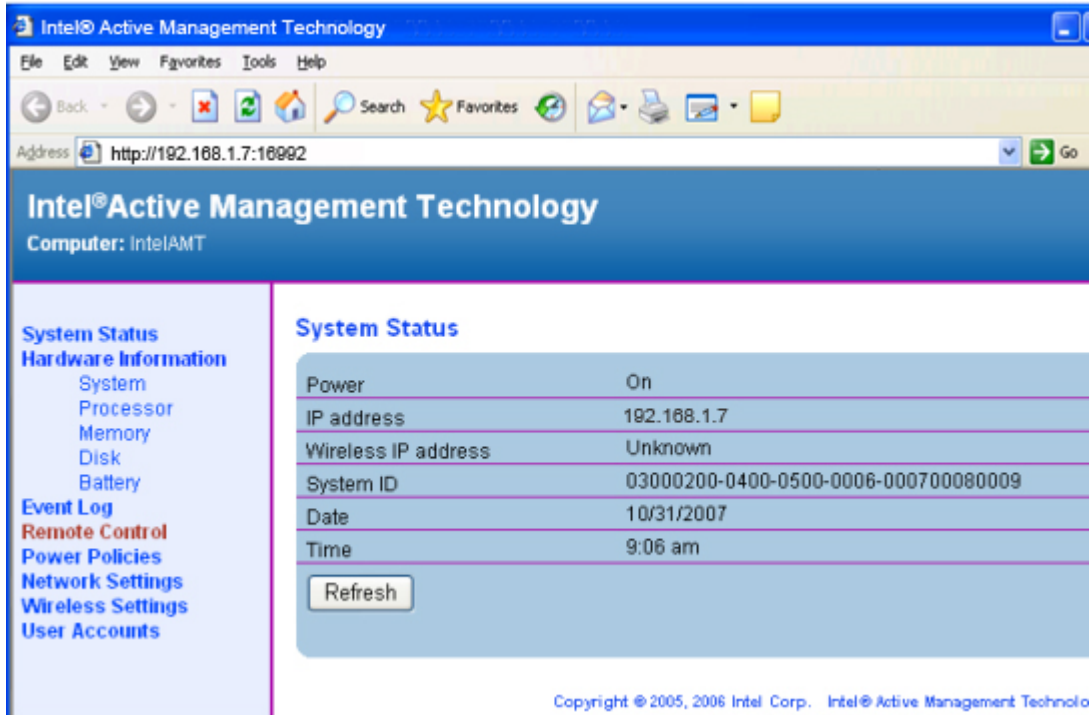

Figure 8-13: Intel® AMT Web Interface



NOTE:

To enhance the platform manageability of the IMB-Q354, work with the Independent Software Vendors (ISV) to implement the Intel® AMT management utility on the system.

Appendix

A

BIOS Options

System Overview	112
System Time [xx:xx:xx].....	113
System Date [xx/xx/xx].....	113
SATA#1 Configuration [Enhanced].....	116
Configure SATA as [IDE]	116
IDE Master and IDE Slave	117
Auto-Detected Drive Parameters	118
Type [Auto].....	119
ZIP	119
LS-120	119
LBA/Large Mode [Auto]	120
Block (Multi Sector Transfer) [Auto].....	120
PIO Mode [Auto].....	120
DMA Mode [Auto].....	121
S.M.A.R.T [Auto]	122
32Bit Data Transfer [Enabled]	122
Floppy A	123
Serial Port1 Address [3F8/IRQ4]	124
Serial Port2 Address [2F8/IRQ3]	125
Serial Port2 Mode [IrDA]	125
COMB Port Duplex Mode [Half Duplex].....	125
Parallel Port Address [Disabled].....	126
Serial Port3 Address [3E8]	126
Serial Port3 IRQ [10].....	126
Serial Port4 Address [2E8]	126
Serial Port4 IRQ [10].....	127
Serial Port5 Address [2F0].....	127
Serial Port5 IRQ [10].....	127
FAN 2 Mode Setting [Full On Mode]	128
Suspend Mode [S1(POS)]	130
AHCI Port n [Not Detected].....	131

IMB-Q354 uATX Motherboard

SATA Port n [Auto]	132
S.M.A.R.T [Enabled]	132
Intel AMT Support [Enable]	133
BootBlock HECI Message [Disabled]	134
HECI Message [Disabled]	134
End Of Post S5 HECI Message [Disabled]	135
ME-HECI [Disabled]	135
ME-IDER [Disabled]	135
ME-KT [Disabled].....	135
Remote Access [Disabled]	136
Serial Port Number	137
Serial Port Mode	137
Flow Control.....	137
Redirection after BIOS POST	137
Terminal Type	137
VT-UTF8 Combo Key Support.....	137
TCG/TPM Support [No]	138
Clearing the TPM [Press Enter].....	138
USB Configuration	139
USB Devices Enabled	139
USB Function [Enabled]	139
USB 2.0 Controller [Enabled]	140
Legacy USB Support [Enabled]	140
USB2.0 Controller Mode [FullSpeed].....	140
USB Mass Storage Reset Delay [20 Sec]	141
Device ##	142
Emulation Type [Auto]	142
IRQ# [Available]	144
DMA Channel# [Available]	144
Reserved Memory Size [Disabled].....	145
Quick Boot [Enabled].....	146

Quiet Boot [Disabled].....	146
AddOn ROM Display Mode [Force BIOS].....	147
Bootup Num-Lock [On]	147
Boot From LAN Support (82573L) [Disabled]	147
Change Supervisor Password.....	150
Change User Password	150
Clear User Password.....	151
Memory Remap Feature [Enabled]	152
Memory Hole [Disabled].....	152
Initiate Graphic Adapter [PEG/PCI].....	153
Internal Graphics Mode Select [Enable, 8MB]	153
HDA Controller [Enabled]	154
Restore on AC Power Loss [Power Off].....	154
ASF Support [Enabled]	155
Resume on KeyBoard/Mouse [Disabled]	155
Save Changes and Exit	156
Discard Changes and Exit	156
Discard Changes	157
Load Optimal Defaults	157
Load Failsafe Defaults	157

Appendix

B

Terminology

ACPI	Advanced Configuration and Power Interface (ACPI) is an OS-directed configuration, power management, and thermal management interface.
AHCI	Advanced Host Controller Interface (AHCI) is a SATA Host controller register-level interface.
ATA	The Advanced Technology Attachment (ATA) interface connects storage devices including hard disks and CD-ROM drives to a computer.
APM	The Advanced Power Management (APM) application program interface (API) enables the inclusion of power management in the BIOS.
ARMD	An ATAPI Removable Media Device (ARMD) is any ATAPI device that supports removable media, besides CD and DVD drives.
ASKIR	Amplitude Shift Keyed Infrared (ASKIR) is a form of modulation that represents a digital signal by varying the amplitude (“volume”) of the signal. A low amplitude signal represents a binary 0, while a high amplitude signal represents a binary 1.
BIOS	The Basic Input/Output System (BIOS) is firmware that is first run when the computer is turned on and can be configured by the end user
CODEC	The Compressor-Decompressor (CODEC) encodes and decodes digital audio data on the system.
CMOS	Complimentary metal-oxide-conductor is an integrated circuit used in chips like static RAM and microprocessors.
COM	COM refers to serial ports. Serial ports offer serial communication to expansion devices. The serial port on a personal computer is usually a male DB-9 connector.
DAC	The Digital-to-Analog Converter (DAC) converts digital signals to analog signals.
DDR	Double Data Rate refers to a data bus transferring data on both the rising

IMB-Q354 uATX Motherboard

	and falling edges of the clock signal.
DMA	Direct Memory Access (DMA) enables some peripheral devices to bypass the system processor and communicate directly with the system memory.
DIMM	Dual Inline Memory Modules are a type of RAM that offer a 64-bit data bus and have separate electrical contacts on each side of the module.
DIO	The digital inputs and digital outputs are general control signals that control the on/off circuit of external devices or TTL devices. Data can be read or written to the selected address to enable the DIO functions.
EHCI	The Enhanced Host Controller Interface (EHCI) specification is a register-level interface description for USB 2.0 Host Controllers.
EIDE	Enhanced IDE (EIDE) is a newer IDE interface standard that has data transfer rates between 4.0 MBps and 16.6 MBps.
FSB	The Front Side Bus (FSB) is the bi-directional communication channel between the processor and the Northbridge chipset.
GbE	Gigabit Ethernet (GbE) is an Ethernet version that transfers data at 1.0 Gbps and complies with the IEEE 802.3-2005 standard.
GPIO	General purpose input
HDD	Hard disk drive (HDD) is a type of magnetic, non-volatile computer storage device that stores digitally encoded data.
ICH	The Input/Output Control Hub (ICH) is an Intel® Southbridge chipset.
IrDA	Infrared Data Association (IrDA) specify infrared data transmission protocols used to enable electronic devices to wirelessly communicate with each other.
L1 Cache	The Level 1 Cache (L1 Cache) is a small memory cache built into the system processor.

L2 Cache	The Level 2 Cache (L2 Cache) is an external processor memory cache.
LCD	Liquid crystal display (LCD) is a flat, low-power display device that consists of two polarizing plates with a liquid crystal panel in between.
MAC	The Media Access Control (MAC) protocol enables several terminals or network nodes to communicate in a LAN, or other multipoint networks.
PCIe	PCI Express (PCIe) is a communications bus that uses dual data lines for full-duplex (two-way) serial (point-to-point) communications between the SBC components and/or expansion cards and the SBC chipsets. Each line has a 2.5 Gbps data transmission rate and a 250 MBps sustained data transfer rate.
POST	The Power-on Self Test (POST) is the pre-boot actions the system performs when the system is turned-on.
RAID	Redundant Array of Inexpensive Disks (RAID) refers to redundantly backing up data on multiple disks to ensure that if one disk fails, the data is not lost and can be restored from the remaining disks in the array.
RAM	Random Access Memory (RAM) is volatile memory that loses data when power is lost. RAM has very fast data transfer rates compared to other storage like hard drives.
SATA	Serial ATA (SATA) is a serial communications bus designed for data transfers between storage devices and the computer chipsets. The SATA bus has transfer speeds up to 1.5 Gbps and the SATA II bus has data transfer speeds of up to 3.0 Gbps.
S.M.A.R.T	Self Monitoring Analysis and Reporting Technology (S.M.A.R.T) refers to automatic status checking technology implemented on hard disk drives.
UART	Universal Asynchronous Receiver-transmitter (UART) is responsible for asynchronous communications on the system and manages the system's serial communication (COM) ports.

IMB-Q354 uATX Motherboard

UHCI	The Universal Host Controller Interface (UHCI) specification is a register-level interface description for USB 1.1 Host Controllers.
USB	The Universal Serial Bus (USB) is an external bus standard for interfacing devices. USB 1.1 supports 12Mbps data transfer rates, while USB 2.0 supports 480Mbps data transfer rates.
VGA	The Video Graphics Array (VGA) is a graphics display system developed by IBM.

THIS PAGE IS INTENTIONALLY LEFT BLANK

Appendix

C

DIO Interface

C.1 DIO Interface Introduction

The DIO connector on the IMB-Q354 is interfaced to GPIO ports on the ITE IT8712F Super I/O chipset. The DIO has both 4-bit digital inputs and 4-bit digital outputs. The digital inputs and digital outputs are generally control signals that control the on/off circuit of external devices or TTL devices. Data can be read or written to the selected address to enable the DIO functions.



NOTE:

For further information, please refer to the datasheet for the ITE IT8712F Super I/O chipset.

C.2 DIO Connector Pinouts

The following table describes how the DIO connector pins are connected to the Super I/O GPIO port 1.

Pin	Description	Super I/O Pin	Super I/O Pin Description
1	Ground	N/A	N/A
2	VCC	N/A	N/A
3	Output 3	GP27	General purpose I/O port 2 bit 7.
4	Output 2	GP26	General purpose I/O port 2 bit 6.
5	Output 1	GP25	General purpose I/O port 2 bit 5.
6	Output 0	GP24	General purpose I/O port 2 bit 4.
7	Input 3	GP23	General purpose I/O port 2 bit 3.
8	Input 2	GP22	General purpose I/O port 2 bit 2
9	Input 1	GP21	General purpose I/O port 2 bit 1
10	Input 0	GP20	General purpose I/O port 2 bit 0

C.3 Assembly Language Samples

C.3.1 Enable the DIO Input Function

The BIOS interrupt call INT 15H controls the digital I/O. An assembly program to enable digital I/O input functions is listed below.

MOV	AX, 6F08H	Sets the digital port as input
INT	15H	Initiates the INT 15H BIOS call

C.3.2 Enable the DIO Output Function

The BIOS interrupt call INT 15H controls the digital I/O. An assembly program to enable digital I/O output functions is listed below.

MOV	AX, 6F09H	Sets the digital port as output
MOV	BL, 09H	
INT	15H	Initiates the INT 15H BIOS call

THIS PAGE IS INTENTIONALLY LEFT BLANK

Appendix

D

Watchdog Timer

NOTE:

The following discussion applies to DOS environment. IEI support is contacted or the IEI website visited for specific drivers for more sophisticated operating systems, e.g., Windows and Linux.

The Watchdog Timer is provided to ensure that standalone systems can always recover from catastrophic conditions that cause the CPU to crash. This condition may have occurred by external EMI or a software bug. When the CPU stops working correctly, Watchdog Timer either performs a hardware reset (cold boot) or a Non-Maskable Interrupt (NMI) to bring the system back to a known state.

A BIOS function call (INT 15H) is used to control the Watchdog Timer:

INT 15H:

AH – 6FH Sub-function:	
AL – 2:	Sets the Watchdog Timer's period.
BL:	Time-out value (Its unit-second is dependent on the item "Watchdog Timer unit select" in CMOS setup).

Table D-1: AH-6FH Sub-function

Call sub-function 2 to set the time-out period of Watchdog Timer first. If the time-out value is not zero, the Watchdog Timer starts counting down. While the timer value reaches zero, the system resets. To ensure that this reset condition does not occur, calling sub-function 2 must periodically refresh the Watchdog Timer. However, the Watchdog timer is disabled if the time-out value is set to zero.

A tolerance of at least 10% must be maintained to avoid unknown routines within the operating system (DOS), such as disk I/O that can be very time-consuming.

**NOTE:**

When exiting a program it is necessary to disable the Watchdog Timer, otherwise the system resets.

Example program:

```
; INITIAL TIMER PERIOD COUNTER
```

```
;
```

```
W_LOOP:
```

```
    MOV    AX, 6F02H    ;setting the time-out value
```

```
    MOV    BL, 30      ;time-out value is 48 seconds
```

```
    INT    15H
```

```
;
```

```
; ADD THE APPLICATION PROGRAM HERE
```

```
;
```

```
    CMP    EXIT_AP, 1    ;is the application over?
```

```
    JNE    W_LOOP      ;No, restart the application
```

```
    MOV    AX, 6F02H    ;disable Watchdog Timer
```

```
    MOV    BL, 0      ;
```

```
    INT    15H
```

```
;
```

```
; EXIT ;
```

THIS PAGE IS INTENTIONALLY LEFT BLANK

Appendix

E

Address Mapping

E.1 Address Map

I/O address Range	Description
000-01F	DMA Controller
020-021	Interrupt Controller
040-043	System time
060-06F	Keyboard Controller
070-07F	System CMOS/Real time Clock
080-09F	DMA Controller
0A0-0A1	Interrupt Controller
0C0-0DF	DMA Controller
0F0-0FF	Numeric data processor
1F0-1F7	Primary IDE Channel
2F8-2FF	Serial Port 2
378-37F	Parallel Printer Port 1 (LPT1)
3B0-3BB	Intel® Graphics Controller
3C0-3DF	Intel® Graphics Controller
3F6-3F6	Primary IDE Channel
3F7-3F7	Standard floppy disk controller
3F8-3FF	Serial Port 1

Table E-1: IO Address Map

E.2 1st MB Memory Address Map

Memory address	Description
00000-9FFFF	System memory
A0000-BFFFF	VGA buffer
F0000-FFFFFF	System BIOS
1000000-	Extend BIOS

Table E-2: 1st MB Memory Address Map

E.3 IRQ Mapping Table

IRQ0	System Timer	IRQ8	RTC clock
IRQ1	Keyboard	IRQ9	ACPI
IRQ2	Available	IRQ10	LAN
IRQ3	COM2	IRQ11	LAN/USB2.0/SATA
IRQ4	COM1	IRQ12	PS/2 mouse
IRQ5	SMBus Controller	IRQ13	FPU
IRQ6	FDC	IRQ14	Primary IDE
IRQ7	Available	IRQ15	Secondary IDE

Table E-3: IRQ Mapping Table

E.4 DMA Channel Assignments

Channel	Function
0	Available
1	Available
2	Floppy disk (8-bit transfer)
3	Available
4	Cascade for DMA controller 1
5	Available
6	Available
7	Available

Table E-4: IRQ Mapping Table

THIS PAGE IS INTENTIONALLY LEFT BLANK

Appendix

F

Compatibility

**NOTE:**

The compatible items described here have been tested by the IEI R&D team and found to be compatible with the IMB-Q354.

F.1 Compatible Operating Systems

The following operating systems have been successfully run on the IMB-Q354.

- Microsoft Windows XP (SP2)
- Fedora Core 7

F.2 Compatible Processors

The following Intel® LGA775 processors have been successfully tested on the IMB-Q354.

CPU	Model Number	Frequency	FSB
65nm Intel® Core™ 2 Duo	E6850	3.0 GHz	1333 MHz
65nm Intel® Core™ 2 Duo	E6750	2.66 GHz	1333 MHz

F.3 Compatible Memory Modules

**NOTE:**

The memory modules listed below have been tested on the IMB-Q354 other memory modules that comply with the specifications may also work on the IMB-Q354 but have not been tested.

The following memory modules have been successfully tested on the IMB-Q354.

IMB-Q354 uATX Motherboard

Manufacturer	Model No.	Capacity	Speed
Twinmos	8D25JK-TT	512 MB	800 MHz
UMAX	RMUMX-512DDR667C	512 MB	667 MHz

THIS PAGE IS INTENTIONALLY LEFT BLANK

Appendix

G

Intel[®] Matrix Storage Manager

G.1 Introduction

The Intel® ICH9DO chipset can provide data protection for serial ATA (SATA) disks via the Intel® Matrix Storage Manager using one of three fault-tolerant RAID levels: RAID 1, 5 or 10. When using two hard drives, matrix RAID allows RAID 0 and RAID 1 functions to be combined, where critical files can be stored on RAID 1, and RAID 0 can be used for non-critical items such as software. RAID 5 and RAID 0 can be combined to provide higher performance, capacity, and fault tolerance.



CAUTION!

A configured RAID volume (which may consist of multiple hard drives) appears to an operating system as a contingent storage space. The operating system will not be able to distinguish the physical disk drives contained in a RAID configuration.

G.1.1 Precautions

One key benefit a RAID configuration brings is that a single hard drive can fail within a RAID array without damaging data. With RAID1 array, a failed drive can be replaced and the RAID configuration restored.



WARNING!

Irrecoverable data loss occurs if a working drive is removed when trying to remove a failed drive. It is strongly recommended to mark the physical connections of all SATA disk drives. Drive locations can be identified by attaching stickers to the drive bays. If a drive member of a RAID array should fail, the failed drive can then be correctly identified.

IMB-Q354 uATX Motherboard



CAUTION!

Do not accidentally disconnect the SATA drive cables. Carefully route the cables within the chassis to avoid system down time.

G.2 Features and Benefits

- Supports RAID levels 0, 1, 5 and 10
- Supports connectivity to two or more disk drives
- Supported Operating Systems include: Windows XP, Windows Server 2003 and Windows Vista

G.3 Accessing the Intel® Matrix Storage Manager

To access the Intel® Matrix Storage Manager, please follow the steps below.

Step 1: Connect SATA drives to the system. Connect two or more SATA drives to the system. Make sure the drives have the same capacity, are the same type and have the same speed.



NOTE:

Make sure the SATA drives are EXACTLY the same when they are configured in a RAID configuration. If they are not the same size, disk drive capacity is sacrificed and overall performance affected.

Step 2: Enable SATA drives in BIOS. Start the computer and access the BIOS setup program. Enable SATA support for all IDE devices. Refer to the applicable BIOS configuration section in this user manual.

- Step 3: Save and Exit BIOS.** After the **SATA** support option is enabled, save and exit the **BIOS**.
- Step 4: Reboot the system.** Reboot the system after saving and exiting the **BIOS**.
- Step 5: Press Ctrl+I.** During the system boot process, press **Ctrl+I** when prompted to enter the RAID configuration software.
- Step 6: Configure the RAID settings.** Use the Intel® Matrix Storage Manager to configure the RAID array. Brief descriptions of configuration options are given below.
- Step 7: Install the OS.** After the RAID array has been configured, install the OS. To do this, please refer to the documentation that came with the OS.

G.4 RAID Configuration

G.4.1 Creating a RAID Volume



WARNING!

All data previously stored on the member drives of a RAID configuration are destroyed during the RAID initialization process. If “used” drives are used to create a RAID array, make sure the data has been moved or backed up before creating a RAID array out of the disk drives.

-
- Step 1: Select “Create RAID Volume”.** Use the arrow keys to highlight **Create RAID Volume** and press **ENTER**. See **Figure G-1**.

IMB-Q354 uATX Motherboard

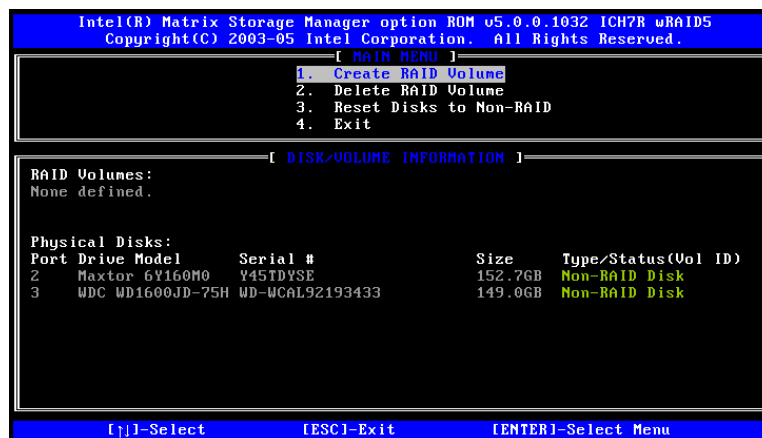

Figure G-1: Matrix Storage Manager Main Menu

Step 2: **Name the RAID volume.** Enter a name for the RAID volume, or press **ENTER** to accept the default volume name. Upper and lower case alphabetic, numeric, space, and underscore characters are all applicable for naming an array. See **Figure G-2.**

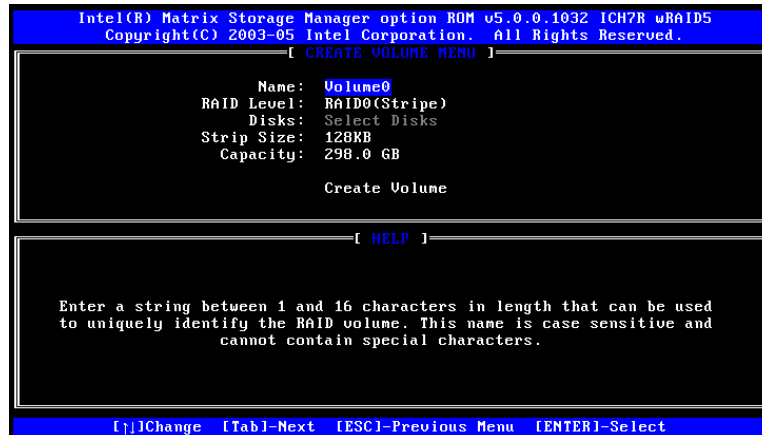

Figure G-2: Create RAID Volume Name

Step 3: **Choose the RAID level.** Select a RAID level from the list. RAID levels include RAID 0, 1, 5 and 10. See **Figure G-3.**

NOTE:

RAID 0 and RAID1 levels require a minimum of two hard drives.

RAID5 level requires a minimum of three hard drives.

RAID10 level requires a minimum of four hard drives.

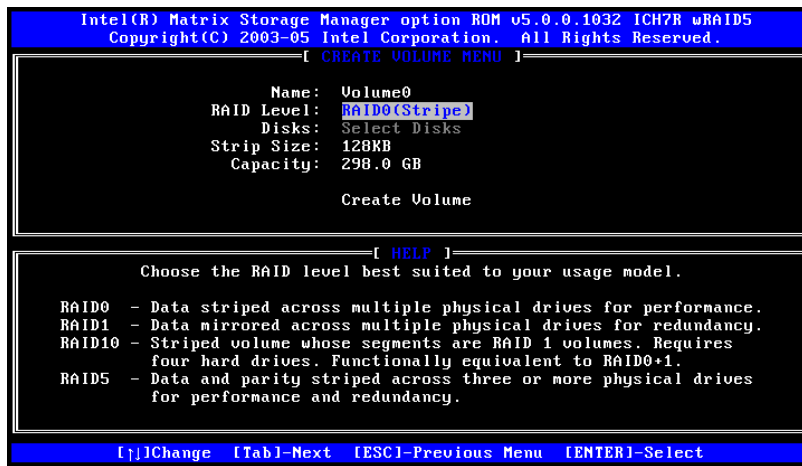

Figure G-3: Choose the Raid Level

Step 4: Select the Stripe Size. Select a stripe size from the list. See **Figure G-4**.

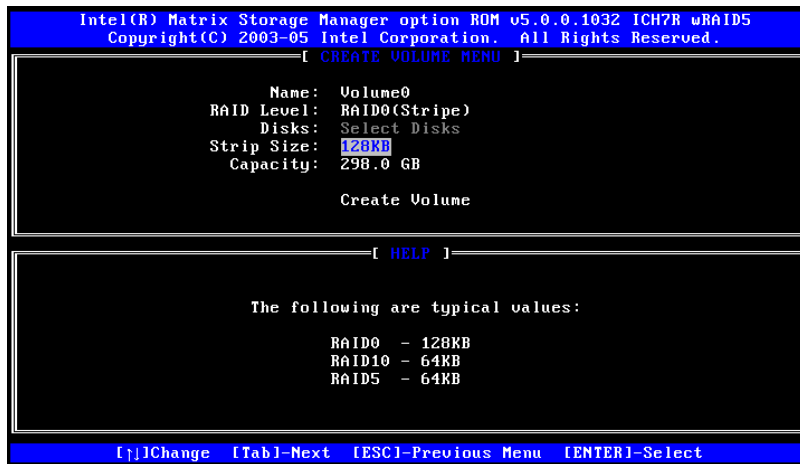

Figure G-4: Select the Stripe Size

Step 5: Enter the Volume Capacity. Enter the volume capacity, or press **ENTER** to accept the default capacity. See **Figure G-5**.

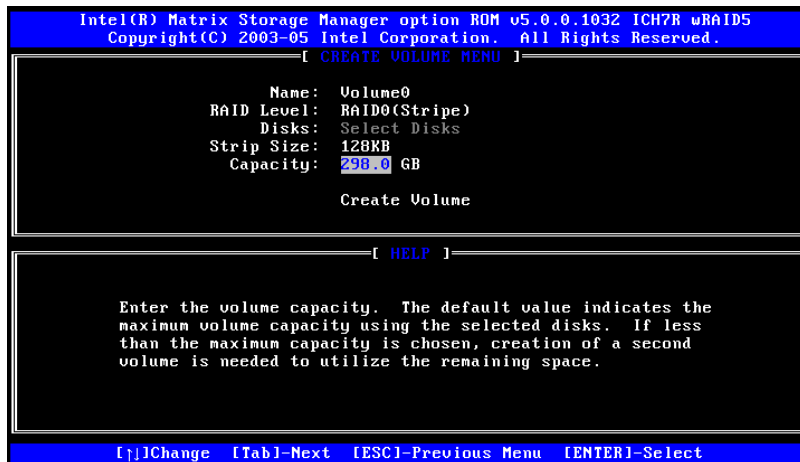

Figure G-5: Enter the Volume Capacity

Step 6: Create the RAID Volume. Press **ENTER** to create the RAID volume as specified. See **Figure G-6**.

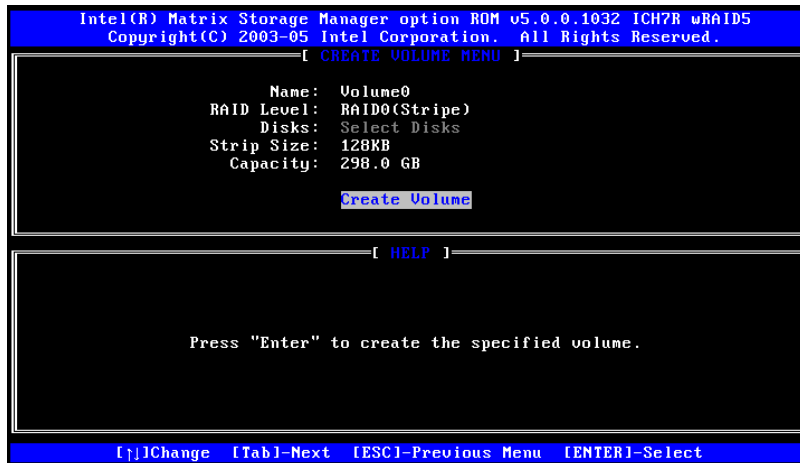

Figure G-6: Create the RAID Volume

Step 7: Create RAID Volume Verification. After reading the warning, press **Y** to create the RAID volume as specified, or **N** to return to the **Create RAID Volume** menu.

See **Figure G-7**.

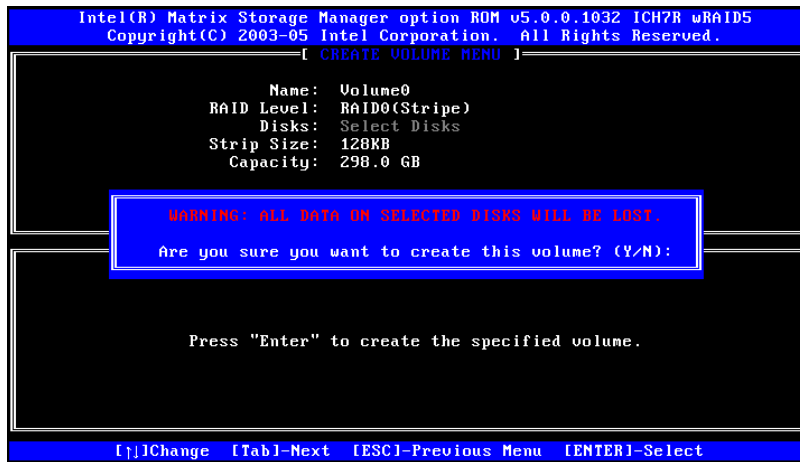

Figure G-7: Create RAID Volume Verification

G.4.2 Deleting a RAID Volume



WARNING!

All data stored on the member drives of a RAID volume are destroyed during the RAID deletion process. Make sure any data to be saved has been moved or backed up before deleting a RAID volume.

Step 1: Select “Delete RAID Volume.” Use the arrow keys to highlight **Delete RAID Volume** and press **ENTER**. See **Figure G-8**.

```

Intel(R) Matrix Storage Manager option ROM v5.0.0.1032 ICH7R wRAID5
Copyright(C) 2003-05 Intel Corporation. All Rights Reserved.

[ MAIN MENU ]
1. Create RAID Volume
2. Delete RAID Volume
3. Reset Disks to Non-RAID
4. Exit

[ DISK/VOLUME INFORMATION ]

RAID Volumes:
ID Name Level Strip Size Status Bootable
0 Volume0 RAID0 (Stripe) 128KB 298.0GB Normal Yes

Physical Disks:
Port Drive Model Serial # Size Type/Status(Vol ID)
2 Maxtor 6Y160M0 Y45TDYSE 152.7GB Member Disk(0)
3 WDC WD1600JD-75H WD-WCAL92193433 149.0GB Member Disk(0)

[↑] Select [ESC] Exit [ENTER] Select Menu
    
```

Figure G-8: Delete RAID Volume Menu

Step 2: Select RAID Volume to be Deleted. Use the arrow keys to highlight the RAID volume to be deleted and press **ENTER**. See **Figure G-9**.

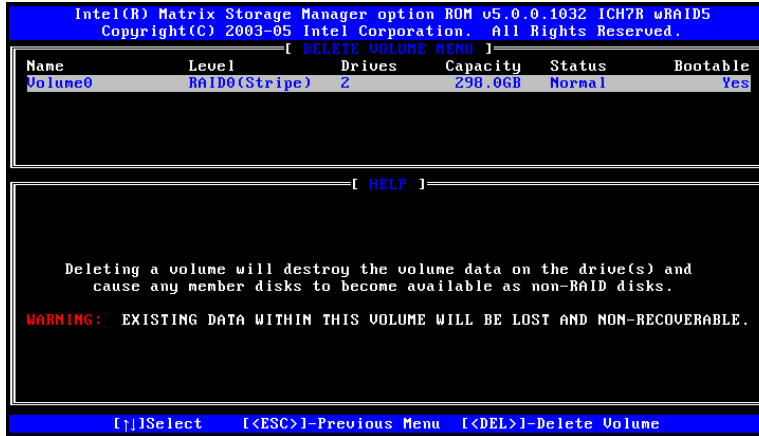

Figure G-9: Select RAID Volume to be Deleted

Step 3: Delete Volume Verification. After reading the warning, press **Y** to delete the specified RAID volume, or **N** to return to the **Delete Volume** menu.

See **Figure G-10**.

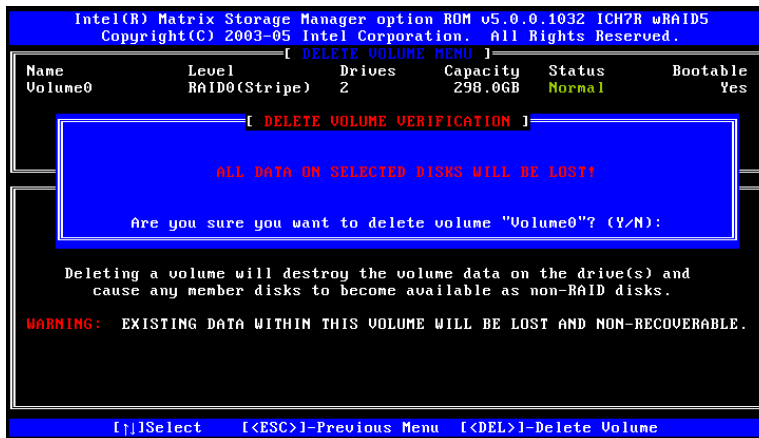

Figure G-10: Delete Volume Verification

Step 4: Non-RAID Disks. After deleting the RAID volume, the disks belonging to the volume will be shown as non-RAID disks. See **Figure G-11**.

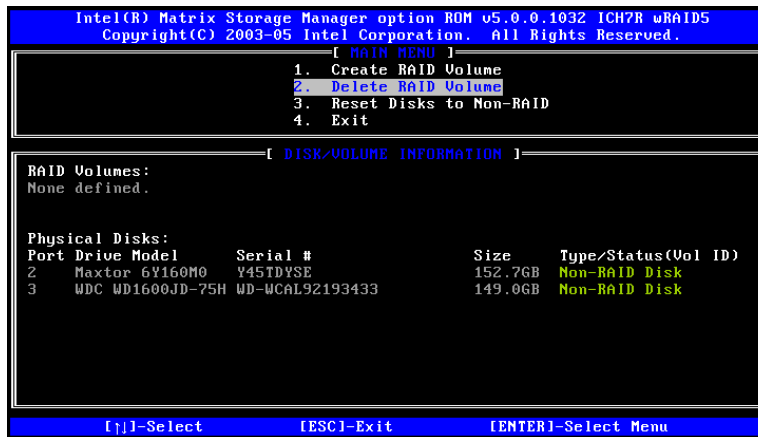

Figure G-11: Non-RAID Disks

G.4.3 Resetting a Disk to Non-RAID



WARNING!

All data stored on the disk drive of a RAID volume is destroyed when resetting it to non-RAID. Make sure any data to be saved has been moved or backed up before resetting a disk to non-RAID.

Step 1: Select “Reset Disk to Non-RAID.” Use the arrow keys to highlight **Reset Disk to Non-RAID** and press **ENTER**. See **Figure G-12**.

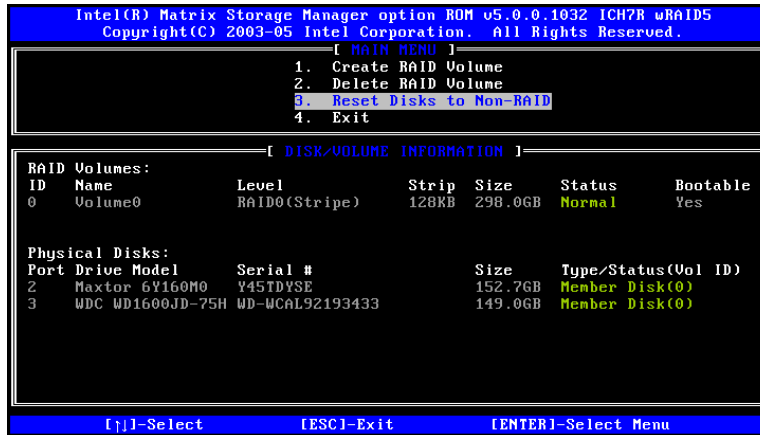

Figure G-12: Reset Disk to Non-RAID Menu

Step 2: Select Disks to Reset. Use the arrow keys to scroll through the disk drives and press **SPACE** to select which drives are to be reset as non-RAID. After all the disks to be reset have been chosen, press **ENTER**. See **Figure G-13**.

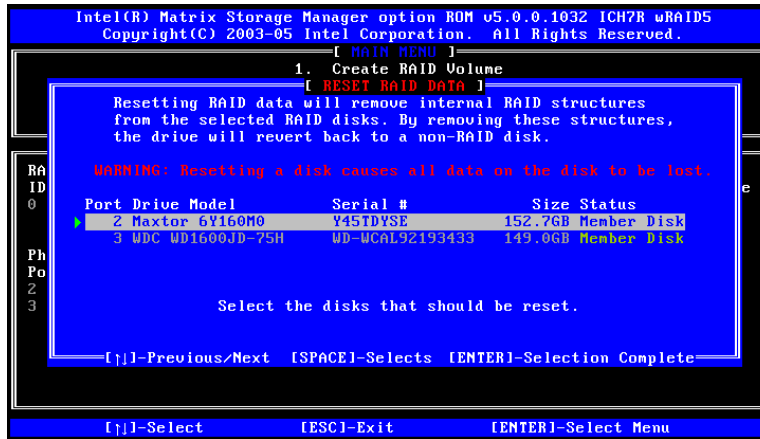

Figure G-13: Select Disk to Reset

Step 3: Reset Disk Verification. After reading the warning, press **Y** to reset the selected disks as non-RAID, or **N** to return to the **Reset RAID Data** menu. See **Figure G-14**.

IMB-Q354 uATX Motherboard

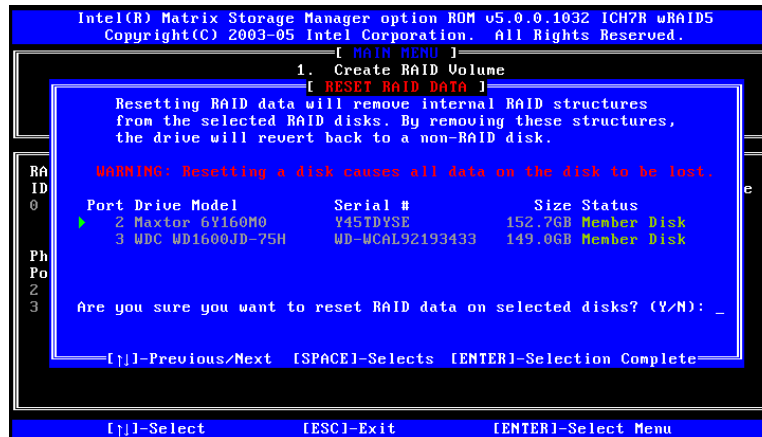

Figure G-14: Reset Disk Verification

Step 4: **Disk Drive and RAID Volume Status.** After the disk drives have been reset, the **Matrix Storage Manager Main** menu is shown indicating the status of the RAID volumes and disk drives. See **Figure G-15**.

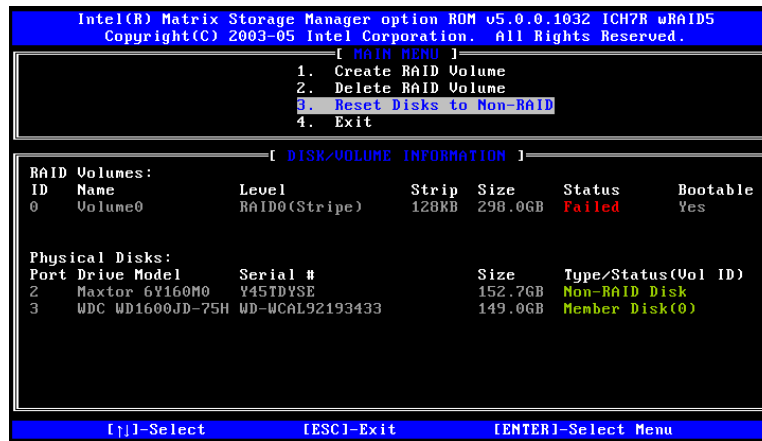

Figure G-15: Disk Drive and RAID Volume Status

G.4.4 Exiting the Matrix Storage Manager

Step 1: Select "Exit." Use the arrow keys to highlight **Exit** and press **ENTER**.

See **Figure G-16**.

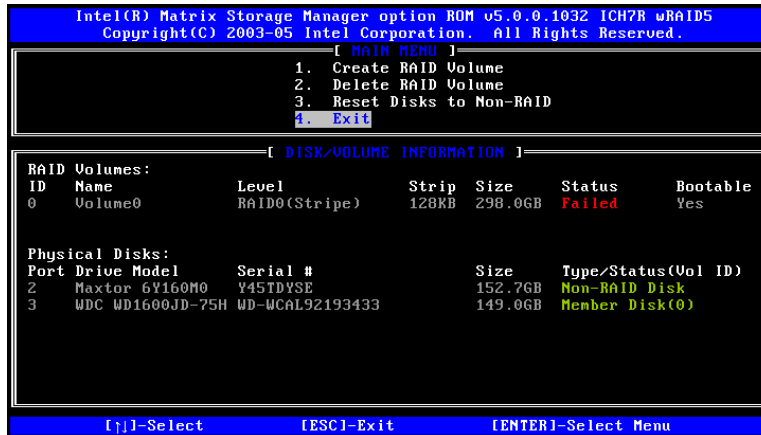

Figure G-16: Exit Menu

Step 2: Exit Verification. Press **Y** to exit the **Matrix Storage Manager**, or **N** to return to the **Main** menu. See **Figure G-17**.

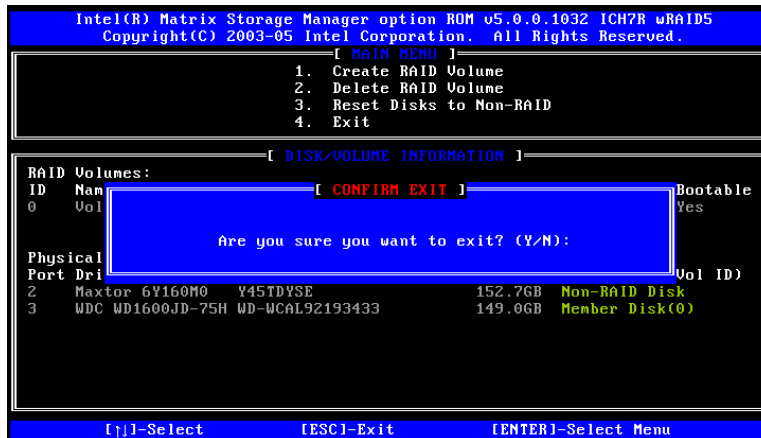

Figure G-17: Exit Verification

Appendix

H

Hazardous Materials Disclosure

H.1 Hazardous Material Disclosure Table for IPB Products Certified as RoHS Compliant Under 2002/95/EC Without Mercury

The details provided in this appendix are to ensure that the product is compliant with the Peoples Republic of China (China) RoHS standards. The table below acknowledges the presences of small quantities of certain materials in the product, and is applicable to China RoHS only.

A label will be placed on each product to indicate the estimated “Environmentally Friendly Use Period” (EFUP). This is an estimate of the number of years that these substances would “not leak out or undergo abrupt change.” This product may contain replaceable sub-assemblies/components which have a shorter EFUP such as batteries and lamps. These components will be separately marked.

Please refer to the table on the next page.

IMB-Q354 uATX Motherboard

Part Name	Toxic or Hazardous Substances and Elements					
	Lead (Pb)	Mercury (Hg)	Cadmium (Cd)	Hexavalent Chromium (CR(VI))	Polybrominated Biphenyls (PBB)	Polybrominated Diphenyl Ethers (PBDE)
Housing	x	O	O	O	O	x
Display	X	O	O	O	O	X
Printed Circuit Board	X	O	O	O	O	X
Metal Fasteners	X	O	O	O	O	O
Cable Assembly	X	O	O	O	O	X
Fan Assembly	X	O	O	O	O	X
Power Supply Assemblies	X	O	O	O	O	X
Battery	O	O	O	O	O	O

O: This toxic or hazardous substance is contained in all of the homogeneous materials for the part is below the limit requirement in SJ/T11363-2006

X: This toxic or hazardous substance is contained in at least one of the homogeneous materials for this part is above the limit requirement in SJ/T11363-2006

此附件旨在确保本产品符合中国 RoHS 标准。以下表格标示此产品中某有毒物质的含量符合中国 RoHS 标准规定的限量要求。

本产品上会附有“环境友好使用期限”的标签，此期限是估算这些物质“不会有泄漏或突变”的年限。本产品可能包含有较短的环境友好使用期限的可替换元件，像是电池或灯管，这些元件将会单独标示出来。

部件名称	有毒有害物质或元素					
	铅 (Pb)	汞 (Hg)	镉 (Cd)	六价铬 (CR(VI))	多溴联苯 (PBB)	多溴二苯醚 (PBDE)
壳体	X	○	○	○	○	X
显示	X	○	○	○	○	X
印刷电路板	X	○	○	○	○	X
金属螺帽	X	○	○	○	○	○
电缆组装	X	○	○	○	○	X
风扇组装	X	○	○	○	○	X
电力供应组装	X	○	○	○	○	X
电池	○	○	○	○	○	○

O: 表示该有毒有害物质在该部件所有物质材料中的含量均在 SJ/T11363-2006 标准规定的限量要求以下。
X: 表示该有毒有害物质至少在该部件的某一均质材料中的含量超出 SJ/T11363-2006 标准规定的限量要求。

Index

A

ACPI	129, 130, 131, 133
Advanced Power Management	155
airflow	95
ATX	51
anti-static precautions.....	42, 78
anti-static pad	42, 78
anti-static wristband.....	42, 78
handling.....	42, 78
self-grounding.....	42, 78
ASKIR interface	61
AT power connector.....	54
location and pinouts	54
ATX power connector	51
audio connector CD in	53
location and pinouts	53
audio connector, external	69
audio connectors	69
Audio device connector	101
audio devices, external.....	69
audio jacks.....	69
audio jacks.....	69

B

BIOS .110, 111, 112, 113, 114, 115, 116, 117, 118, 123, 124, 128, 129, 130, 131, 132, 133, 134, 136, 137, 138, 139, 140, 141, 143, 145, 146, 147, 148, 149, 150, 151, 152, 154, 156

C

cables.....	96
dual port USB	44, 99
dual RS-232.....	43, 96
SATA drive	43, 97
SATA drive power	43, 97
chassis	95
installation.....	95
chipset.....	20
southbridge	20
chipset driver.....	166
clear CMOS jumper	5, 91
location	92
settings	92
CMOS	91
clear CMOS jumper	91
COM	
pin 9 setup jumper	92
pin 9 voltage setup jumper	94
COM port pin 9 setting jumper.....	92
location	93
settings	93
COM port pin 9 voltage setting jumper	94
location	94
settings	94
connectors, external	
audio jacks.....	69
keyboard PS/2 connector	70
LAN connector.....	71
mouse PS/2 connector	70
parallel port.....	73
RJ-45 connector	71

IMB-Q354 uATX Motherboard

connectors, pinouts and location		digital input/output connector	55
ATX power	51	location and pinouts.....	55
Audio	59	dimensions.....	10
audio CD in.....	53	board	10
CPU fan	56	external peripheral interface connector	
CPU power	54	panel.....	11
Digital Input/Output.....	54	DIMM	87
fan.....	56, 57	installation.....	87
floppy disk	58	specifications.....	87
front panel.....	60	Drivers	
infrared interface	61	Intel® Matrix Storage Manager	193
PCIe power.....	62	Realtek HD Audio	187
SATA.....	63	dual port USB cable.....	99
serial ports	64		
SPDIF	65	E	
system fan	57	electrostatic discharge	42, 78
trusted platform module (TPM).....	66	Enhanced Hardware Monitor	34
USB (internal).....	68	Ethernet	
cooling	95	RJ-45 connector	5
airflow	95	Ethernet connector, external.....	71
cooling fan	56, 57, 86, 129	Ethernet controllers.....	71
cooling kit installation.....	85	external indicators.....	60
CPU		external peripheral interface	101
cooling fan	86	connection	101
heat sink	86	connectors	101
installation.....	82	external switches	60
CPU cooling fan.....	56		
CPU fan connector	56	F	
location and pinouts	56	fan connector	57
		location and pinouts.....	57
D		fan connector	56
DB-15 connector.....	107	location and pinouts.....	56
DB-25 connector.....	103	fan speed controller	35
DB-9 connector.....	105	FDD.....	124

floppy disk connector	58
location and pinouts	58
floppy disk drive	58
front panel connector	60
location and pinouts	60
FSB	115

H

hard disk drives	
SATA	63
heat sink	86
HT technology	82
system requirements	82
hyper-threading technology	82
system requirements	82

I

infrared interface	61
Amplitude Shift Key Infrared	61
ASKIR	61
Serial Infrared	61
SIR	61
infrared interface connector	61
location and pinouts	61
installation checklist	80
IrDA	125, 126, 132

J

jumper	90, 91
clear CMOS	91
COM pin 9 voltage setting	94
COM port pin 9 setting	92
jumper configuration	91

jumper settings	90
-----------------------	----

K

keyboard connector	70
keyboard connector	70
keyboard controller	35

L

LAN connection	102
LAN connector	71
LPC bus	31
LPC interface	23, 33

M

memory module installation	87
motherboard	96
installation	96
mouse connector	70

P

Parallel Device Connection	103
parallel port	35, 73
PCI bus	30
PCI interface	24
PCIe power connector	62
location and pinouts	62
PCIe x16 card	100
installation	100
PCIe x16 expansion card installation	100
peripheral connectors	51
peripheral device cables	96
power button	60
Power Button Mode	131

IMB-Q354 uATX Motherboard

power supply.....	54, 62	SATA drives.....	63
AT power supply	54	Serial Device	
PCIe power supply	62	connection	105
PS/2 connector	70	serial port connector	65, 74
PS/2 connector	70	location and pinouts.....	65, 74
PS/2 keyboard and mouse		serial ports	34
connection	104	SIR interface	61
R			
RAID	63	socket LGA775 CPU	
real time clock.....	24	cooling kit.....	85
RJ-45 connection.....	102	cooling kit installation.....	85
single connector	102	installation.....	82
RJ-45 connector	71	southbridge chipset.....	20
RJ-45 connector	72	Super I/O chipset	32
RJ-45 Ethernet connector.....	5	system cooling fan	57
RJ-45 LAN connector	71	system fan connector.....	57
RS-232.....	65, 74, 96	location and pinouts.....	57
cable connection	96	system voltages	128, 129
COM 1 location and pinouts.....	74	T	
COM 2 location and pinouts.....	65	technical specifications	6
connector location and pinouts.....	65, 74	temperature.....	128
dual cable	96	trusted platform module	67
serial port devices	65	trusted platform module (TPM) connector	67
RS-232 serial port devices	65	location and pinouts.....	67
S			
Safety Precautions.....	238	U	
SATA drive	97	unpacking.....	42, 81
cables	97	unpacking checklist	43
connection	97	unpacking precautions.....	42, 81
power cable	97	USB.....	68, 99, 138, 139, 140
SATA drive connector	63	cable	
location and pinouts	63	dual port	99
		cable	99
		cable connection.....	99

IMB-Q354 uATX Motherboard

connectors	99
devices	68
external USB device connection	106
port	68
USB 1.1	68
USB 2.0	68
USB 1.1	68
USB 2.0	68, 140
USB 2.0 connectors.....	5
USB 2.0 port	72
USB cable	
dual port	99
USB connector, internal.....	68

location and pinouts.....	68
USB device connection.....	106
single connector	106

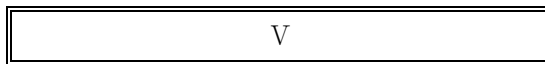

VGA	107
VGA connector	5
VGA monitor.....	107
connection	107

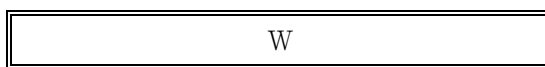

warranty validation.....	80
--------------------------	----