



## **LNX-0802C-SFP Series**

**8-Port Industrial Unmanaged Ethernet Switches, with  
6\*10/100Tx and 2\* Gigabit Combo Ports (2\*10/100/1000Tx RJ45,  
and 2\*100/1000 SFP Slots)**



### **User Manual**

Version 1.2



## © Copyright 2018 Antaira Technologies, LLC

All Rights Reserved

This document contains information, which is protected by copyright. Reproduction, adaptation or translation without prior permission is prohibited, except as allowed under the copyright laws.

## Trademark Information

Antaira is a registered trademark of Antaira Technologies, LLC, Microsoft Windows and the Windows logo are the trademarks of Microsoft Corp. NetWare is the registered trademark of Novell Inc. WMM and WPA are the registered trademarks of Wi-Fi Alliance. All other brand and product names are trademarks or registered trademarks of their respective owners.

**Notice:** Copyrights © 2018 by Antaira Technologies, LLC. All rights reserved. Reproduction, adaptation, or translation without prior permission of Antaira Technologies, LLC is prohibited, except as allowed under the copyright laws.

## Disclaimer

Antaira Technologies, LLC provides this manual without warranty of any kind, expressed or implied, including but not limited to the implied warranties of merchantability and fitness for a particular purpose. Antaira Technologies, LLC may make improvements and/or changes to the product and/or specifications of the product described in this manual, without prior notice. Antaira Technologies, LLC will not be liable for any technical inaccuracies or typographical errors found in this guide. Changes are periodically made to the information contained herein and will be incorporated into later versions of the manual. The information contained is subject to change without prior notice.

## **FCC Notice**

This equipment has been tested and found to comply with the limits for a Class-A digital device, pursuant to Part 15 of the FCC rules. These limits are designed to provide reasonable protection against harmful interference in a residential installation. This equipment generates, uses, and can radiate radio frequency energy. It may cause harmful interference to radio communications if the equipment is not installed and used in accordance with the instructions. However, there is no guarantee that interference will not occur in a particular installation. If this equipment does cause harmful interference to radio or television reception, which can be determined by turning the equipment off and on, the user is encouraged to try to correct the interference by one or more of the following measures:

- Reorient or relocate the receiving antenna.
- Increase the separation between the equipment and receiver.
- Connect the equipment into an outlet on a circuit different from that to which the receiver is connected.
- Consult the dealer or an experienced radio/TV technician for help.

**Caution:** Any changes or modifications not expressly approved by the grantee of this device could void the user's authority to operate the equipment.

## **CE Mark Warning**

This is a Class-A product. In a domestic environment this product may cause radio interference in which case the user may be required to take adequate measures.

## **Industrial Ethernet Switches**

Industrial Grade Gigabit Unmanaged Ethernet Switches

User Manual

Version 1.2 (April 2018)

This manual supports the following models:

- LNX-0802C-SFP
- LNX-0802C-SFP-T

This document is the current official release manual. Please check our website ([www.antaira.com](http://www.antaira.com)) for any updated manual or contact us by e-mail ([support@antaira.com](mailto:support@antaira.com)).

# Table of Contents

<b>1. Overview .....</b>	<b>1</b>
1.1 Key Features .....	1
1.2 Package Contents .....	2
1.3 Safety Precaution.....	2
<b>2. Hardware Description .....</b>	<b>3</b>
2.1 Physical Dimensions .....	3
2.2 Front Panel.....	4
2.3 Top View .....	4
2.4 LED Indicators .....	5
2.5 Ethernet Ports.....	6
2.6 Cabling .....	8
2.6.1 Gigabit Combo Port - Copper/SFP (Mini-GBIC) .....	8
2.7 Wiring the Power Inputs.....	11
2.8 Wiring the Fault Alarm Contact .....	12
<b>3. Mounting Installation .....</b>	<b>13</b>
3.1 DIN-Rail Mounting .....	13
3.2 Wall Mounting.....	15
<b>4. Hardware Installation .....</b>	<b>16</b>
4.1 Installation Steps .....	16
<b>5. Network Application .....</b>	<b>17</b>
<b>6. Trouble Shooting.....</b>	<b>18</b>
<b>7. Technical Specifications .....</b>	<b>19</b>

# 1. Overview

Antaira Technologies' LNX-0802C-SFP industrial Gigabit unmanaged Ethernet switch series is IP30 rated and DIN-Rail mountable with 6\*10/100Tx + 2\*GigE combo ports (2\*10/100/1000Tx RJ45, and 2\*100/100 SFP slots for fiber), making it ideal for applications that demand high bandwidth and long distance communication.

This product series provides a high EFT and ESD protection to prevent any unregulated voltage and is suitable for harsh environments. It supports the power redundancy feature by having a dual power input design with reverse power polarity protection. In addition, the built-in relay warning function alerts maintainers when power failures occur.

The LNX-0802C-SFP series includes two models: one with an operating temperature range of -10 to 70°C, and the other one with an extended operating temperature range of -40 to 75°C. It is a perfectly designed product to fulfill any special needs for industrial automation, outdoor applications and harsh weather environments.

## 1.1 Key Features

- System Interface/Performance
  - All RJ-45 ports support the auto MDI/MDI-X function
  - Embedded 6\*10/100Tx, 2\*Gigabit combo ports (2\*10/100/1000Tx RJ45, and 2\*100/1000 SFP)
  - Store-and-forward switching architecture
  - 8K MAC address table
  - Power line EFT protection: 2,000VDC; Ethernet ESD protection: 6,000VDC
- Power Input
  - DC 12~48V redundant power
- Operating Temperature
  - Standard operating temperature model: -10°C ~ 70°C
  - Extended operating temperature model (-T): -40°C ~ 75°C
- Case/Installation
  - IP-30 protection
  - DIN-Rail and wall mount design

## 1.2 Package Contents

- 1 - LNX-0802C-SFP (T): 8-port industrial unmanaged Ethernet switch, with 6\*10/100Tx, 2\* Gigabit combo ports (2\*10/100/1000Tx RJ45, and 2\* 100/1000 SFP slots)
- 1 - User manual
- 1 - Product CD
- 2 - Wall mounting brackets and screws
- 1 - DC cable –18 AWG & DC jack 5.5x2.1mm

## 1.3 Safety Precaution

**Attention:** If the DC voltage is supplied by an external circuit, please use a protection device on the power supply input. The industrial Ethernet switch's hardware specs, ports, cabling information, and wiring installation will be described within this user manual.

## 2. Hardware Description

### 2.1 Physical Dimensions

Figure 2.1, below, shows the physical dimensions of Antaira Technologies' LNX-0802C-SFP series: 8-port industrial unmanaged Ethernet switches, with 6\*10/100Tx, 2\* Gigabit combo ports (2\*10/100/1000Tx RJ45, and 2\* 100/1000 SFP slots).

(W x D x H) is **46mm x 99mm x 142mm**

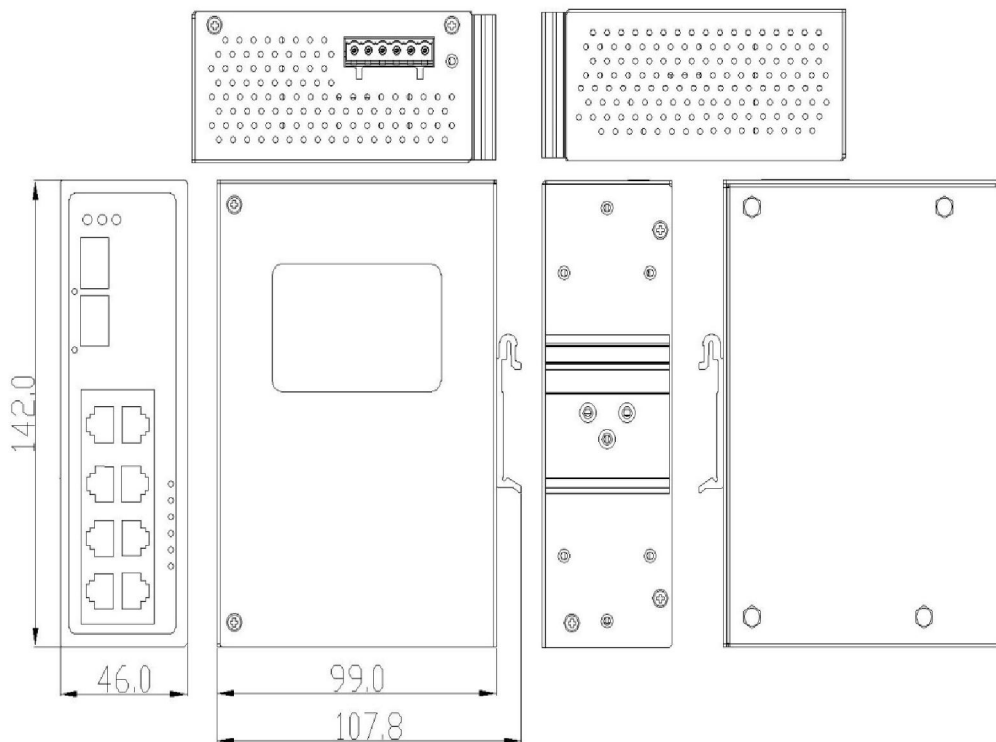
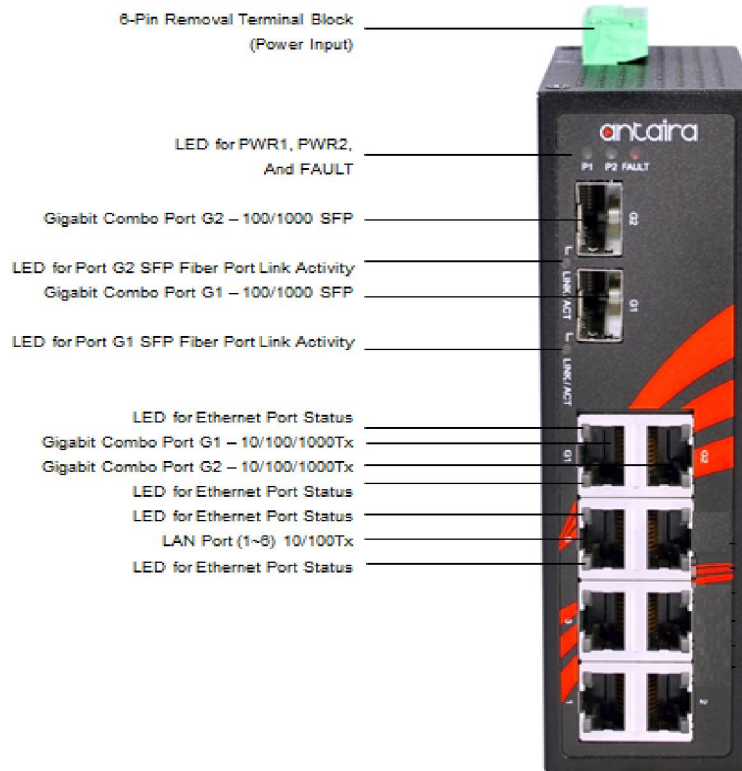


Figure 2.1

LNX-0802C-SFP Series Physical Dimensions

## 2.2 Front Panel

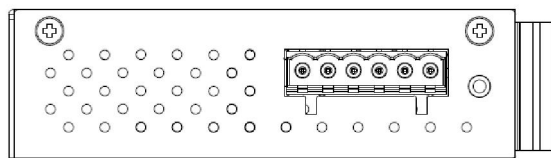
The front panel of the LNX-0802C-SFP series: 8-port industrial unmanaged Ethernet switches, with 6\*10/100Tx, 2\* Gigabit combo ports (2\*10/100/1000Tx RJ45, and 2\* 100/1000 SFP slots) is shown below in *Figure 2.2*.



*Figure 2.2 - The Front Panel of the LNX-0802C-SFP Series*

## 2.3 Top View

*Figure 2.3*, below, shows the top panel of the LNX-0802C-SFP switch series that is equipped with one 6-pin removal terminal block connector for dual DC power inputs (12~48VDC).





*Figure 2.3 - Top Panel View of LNX-0802C-SFP Series*



## 2.4 LED Indicators

There are LED light indicators located on the front panel of the industrial Ethernet switch that display the power status and network status. Each LED indicator has a different color and has its own specific meaning, see below in *Table 2.1*.

LED	Color	Description	
P1	Green	On	Power input 1 is active
		Off	Power input 1 is inactive
P2	Green	On	Power input 2 is active
		Off	Power input 2 is inactive
Fault	Red	On	Power input 1 or 2 is inactive
		Off	Power input 1 and 2 are both functional, or no power, inputs/ports link is active/port alarm is disabled
LAN Port 1 ~ 6 (Upper LED)	Green 	On	Connected to network, 100Mbps
		Flashing	Networking is active
		Off	Not connected to network
LAN Port 1 ~ 6 (Lower LED)	Green 	On	Connected to network, 10Mbps
		Flashing	Networking is active
		Off	Not connected to network

### Gigabit Combo Port LED Indicators



LED	Color	Description	
SFP Port Combo G1~G2 LNK/ACT	Green	On	Connected to network
		Flashing	Networking is active
		Off	Not connected to network
LAN Port Combo G1 ~G2 (Upper LED)	Green 	On	Connected to network, 1000Mbps
		Flashing	Networking is active
		Off	Not connected to network
LAN Port Combo G1 ~G2 (Lower LED)	Green 	On	Connected to network, 10/100Mbps
		Flashing	Networking is active
		Off	Not connected to network

Table 2.1 - LED Indicators for the LNX-0802C-SFP Series

## 2.5 Ethernet Ports

### ■ RJ-45 Ports

**RJ-45 Ports (Auto MDI/MDIX):** The RJ-45 ports (LAN 1~6) are auto-sensing for 10Base-T or 100Base-Tx device connections. The Gigabit combo RJ-45 ports (LAN G1~G2) are auto-sensing for 10Base-T, 100Base-Tx, and 1000Base-T device connections. Auto MDI/MDIX means that the switch can connect to another switch or workstation without changing the straight-through or crossover cabling. See the figures below for straight-through and crossover cabling schematics.

### ■ RJ-45 Pin Assignments (Table 2.2)

Pin Number	Assignment
1	Rx+
2	Rx-
3	Tx+
6	Tx-

Table 2.2  
RJ45 Pin Assignments

**Note** “+” and “-” signs represent the polarity of the wires that make up each wire pair.

All ports on this industrial Ethernet switch support automatic MDI/MDI-X operation. Users can use straight-through cables (see figure below) for all network connections to PCs, servers, other switches or hubs. With straight-through cabling, pins 1, 2, 3, and 6 are at one end of the cable and are connected straight through to pins 1, 2, 3 and 6 at the other end of the cable. The table below (Table 2.3) shows the 10BASE-T/100BASE-TX/1000BASE-T MDI and MDI-X port pin outs.

Pin MDI-X	Signal Name	MDI Signal Name
1	Receive Data Plus (RD+)	Transmit Data Plus (TD+)
2	Receive Data Minus (RD-)	Transmit Data Minus (TD-)
3	Transmit Data Plus (TD+)	Receive Data Plus (RD+)
6	Transmit Data Minus (TD-)	Receive Data Minus (RD-)

Table 2.3 - Ethernet Signal Pin Outs

The following figures show the cabling schematics for straight-through and crossover.

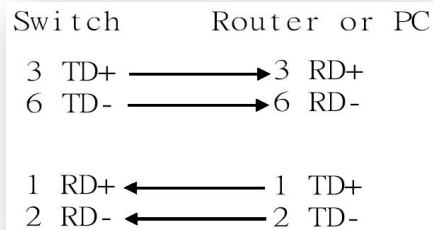


Figure 2.4 - Straight-Through Cable Schematic

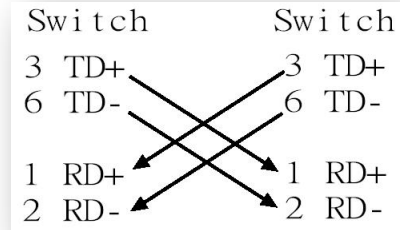


Figure 2.5 - Crossover Cable Schematic

The following figures show the 10 and 100 Ethernet RJ-45 pin outs.

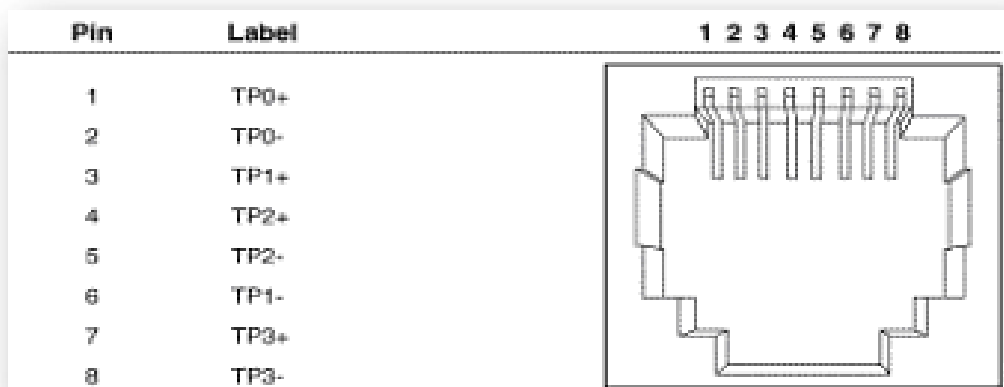


Figure 2.6 - RJ45 Ethernet Port Pin Outs

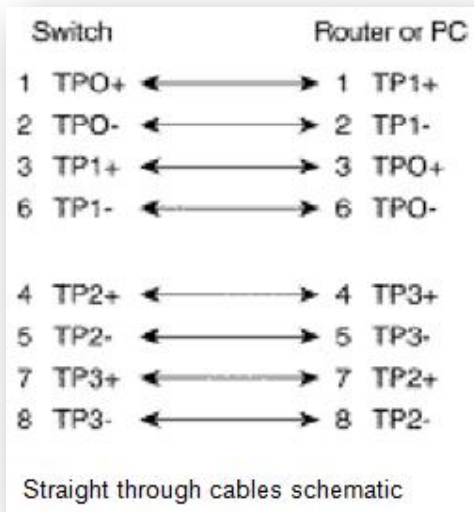


Figure 2.7 - Straight-Through Cable Schematic

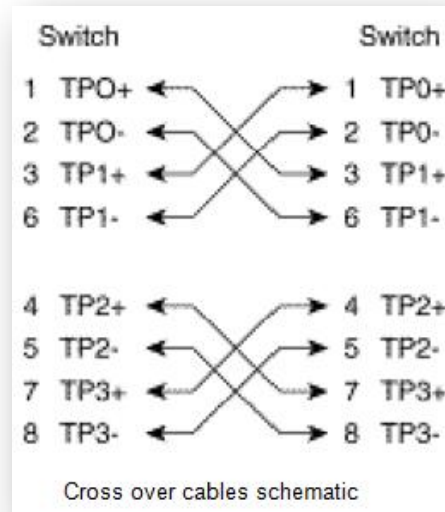


Figure 2.8 - Crossover Cable Schematic

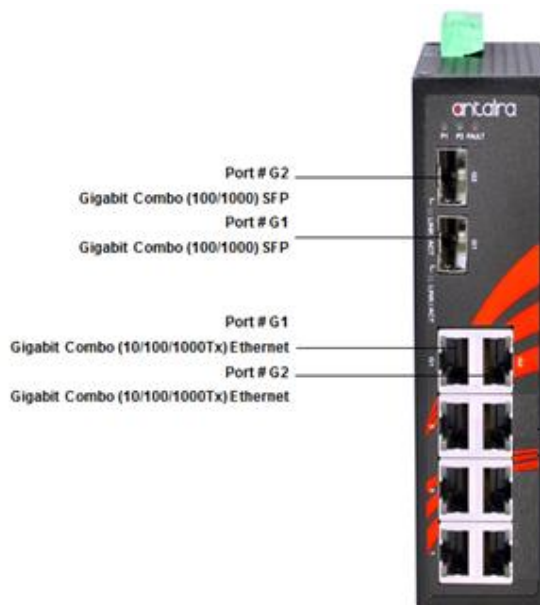
## 2.6 Cabling

Use the four twisted-pair, category 5e, or the above cabling for the RJ-45 port connections. The cable between the switch and the link partner (switch, hub, workstation, etc.) must be less than 100 meters (328 ft.) in length.

### 2.6.1 Gigabit Combo Port - Copper/SFP (Mini-GBIC)

Antaira's LNX-0802C-SFP series has two auto-detected Gigabit combo ports (2\*10/100/1000Tx RJ45, and 2\*100/1000 SFP slots for fiber connection).

- The Gigabit copper (10/100/1000T) ports should use category 5e or the above UTP/STP cable for the connection up to 1000Mbps. The small form-factor pluggable (SFP) is a compact optical transceiver used in optical communications for both telecommunication and data communications.
- The SFP slots support dual rate mode, which can switch the connection speed between 100 and 1000Mbps. They are used for connecting to the network segment with single or multi-mode fiber. Users must first choose the appropriate SFP transceiver to plug into the slots, and then choose the proper multi-mode or single-mode fiber according to the transceiver being used. When fiber optic is used, it transmits at a speed up to 1000 Mbps and it can prevent noise interference from the system.



---

#### **\*\*Note:**

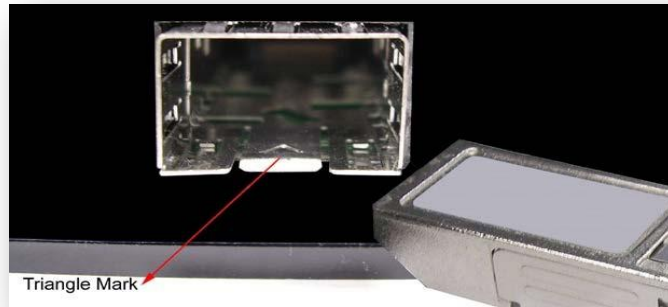
**The Gigabit combo ports (SFP/Copper) cannot be working at the same time.** The SFP port has the higher priority than the copper port. When inserting a 100M or 1000M SFP transceiver (which has connected to the remote device via fiber cable) into the SFP port, the connection of the accompanying copper port will be linked down.

---

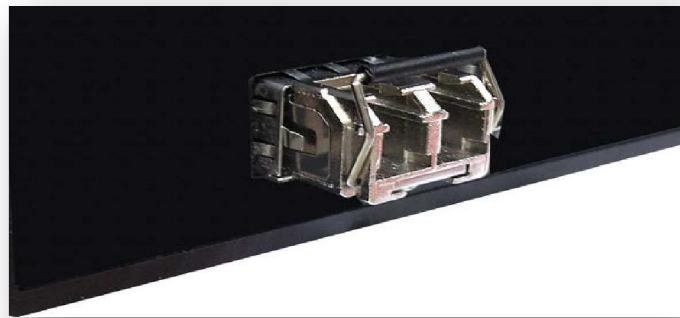
The small form-factor pluggable (SFP) is a compact optical transceiver used in optical communications for both telecommunication and data communication applications.

To connect the transceiver and LC cable, please follow the steps below:

First, insert the SFP transceiver module into the SFP slot as shown below in *Figure 2.9*. Notice that the triangle mark is at the bottom of the SFP slot. *Figure 2.10* shows SFP transceiver module was inserted.

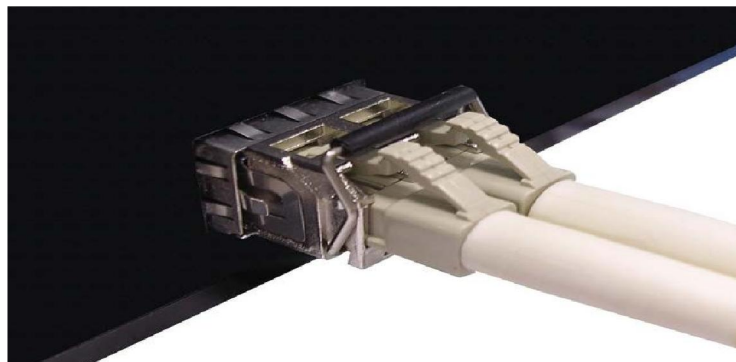


*Figure 2.9 Transceiver to the SFP Module*



*Figure 2.10 Transceiver Inserted*

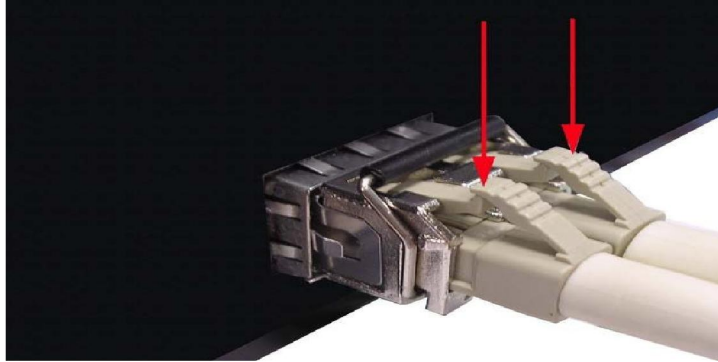
Second, insert the fiber cable of the LC connector into the transceiver as shown below in *Figure 2.11*.



*Figure 2.11 - LC Connector to the Transceiver*

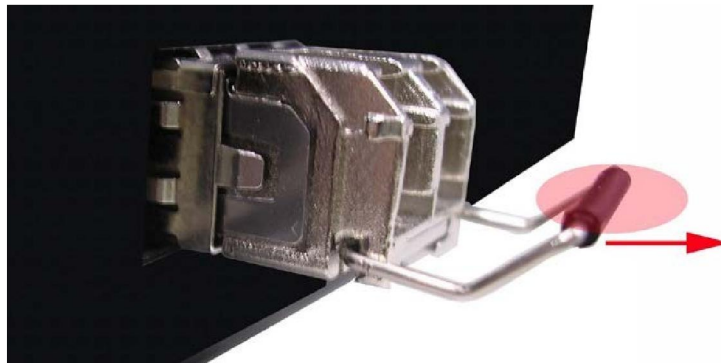
To remove the LC connector from the transceiver, please follow the steps shown below:

1. Press the upper side of the LC connector from the transceiver and pull it out to release as shown below in *Figure 2.12*.



*Figure 2.12*  
*Remove LC Connector*

2. Push down the metal clasp and pull the transceiver out by the plastic part as shown below in *Figure 2.13*.

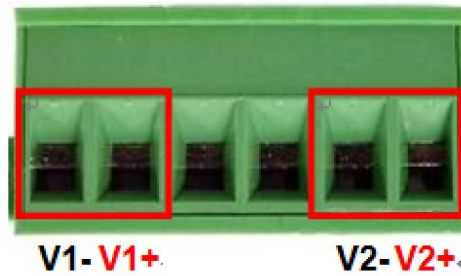


*Figure 2.13*  
*Pull Out from the SFP Module*

## 2.7 Wiring the Power Inputs

Please follow the steps below to insert the power wire.

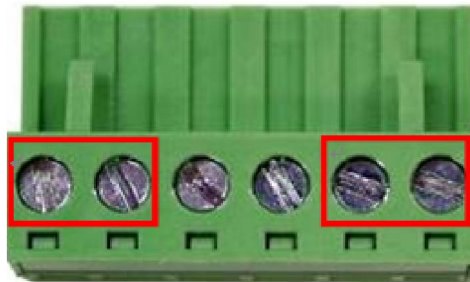
1. Insert the positive and negative wires into the PWR1 (V1+, V1-) and PWR2 (V2+, V2-) contacts on the terminal block connector as shown below in *Figure 2.14*.



*Figure 2.14*

*Power Terminal Block*

2. Tighten the wire-clamp screws to prevent the wires from loosening, as shown below in *Figure 2.15*.



*Figure 2.15*

*Power Terminal Block*

- 
- \*\*Note:**
- Only use copper conductors, 60/75°C, tighten to 5 lbs.
  - The wire gauge for the terminal block should range between 18~20 AWG.
-

## 2.8 Wiring the Fault Alarm Contact

The fault alarm contact is in the middle of the terminal block connector as the picture shows below in *Figure 2.16*. By inserting the wires, it will detect the fault status including power failure or port link failure (managed industrial switch only) and form a normal open circuit. An application example for the fault alarm contact is shown below in *Figure 2.16*.

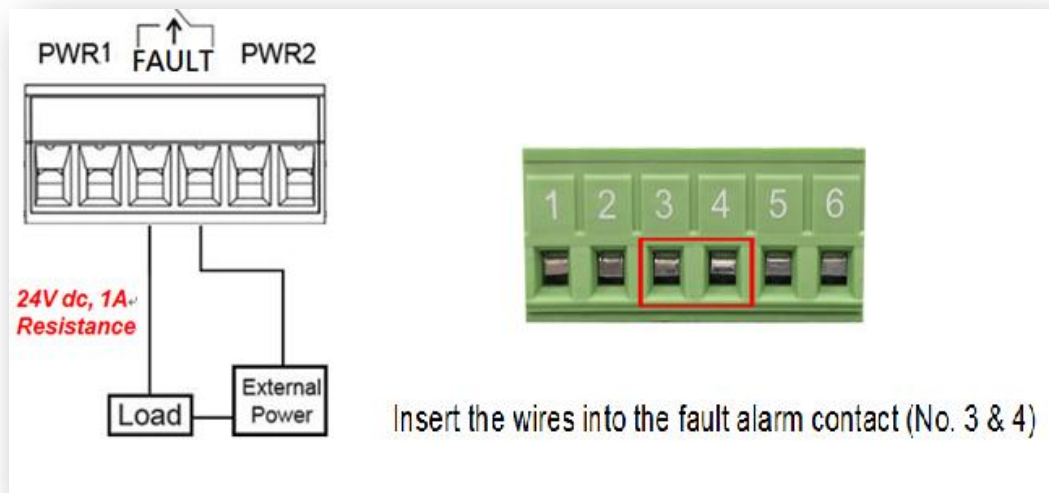


Figure 2.16

Wiring the Fault Alarm Contact

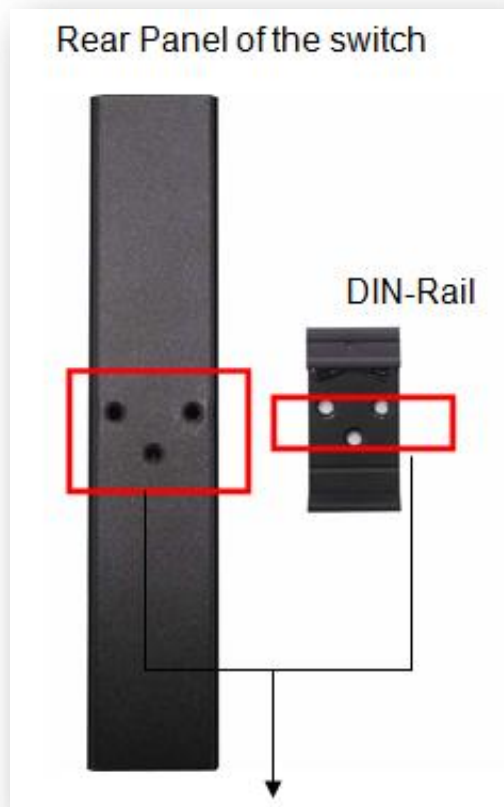
- 
- \*\*Note:**
- The wire gauge for the terminal block should range between 12 ~ 24 AWG.
  - If only using one power source, jumper Pin 1 to Pin 5 and Pin 2 to Pin 6 to eliminate the power fault alarm.
-



## 3. Mounting Installation

### 3.1 DIN-Rail Mounting

The DIN-Rail is pre-installed on the industrial Ethernet switch from the factory. If the DIN-Rail is not on the industrial Ethernet switch, please see *Figure 3.1* to learn how to install the DIN-Rail on the switch.



*Figure 3.1*

*The Rear Side of the Switch and DIN-Rail Bracket*

Follow the steps below to learn how to hang the industrial Ethernet switch.

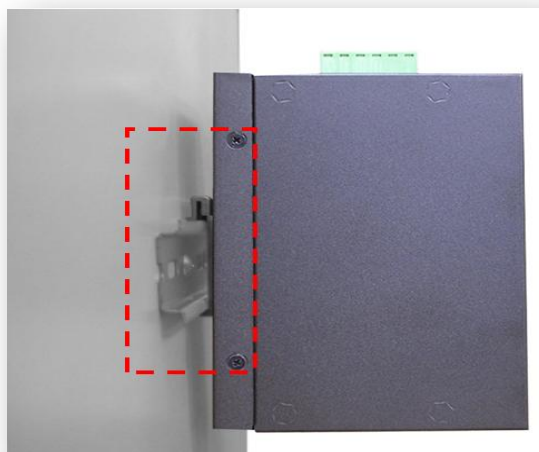
1. Use the screws to install the DIN-Rail bracket on the rear side of the industrial Ethernet switch.
2. To remove the DIN-Rail bracket, do the opposite from step 1.
3. After the DIN-Rail bracket is installed on the rear side of the switch, insert the top of the DIN-Rail on to the track as shown below in *Figure 3.2*.



*Figure 3.2*

*Insert the Switch on the DIN-Rail*

4. Lightly pull down the bracket on to the rail as shown below in *Figure 3.3*.



*Figure 3.3*

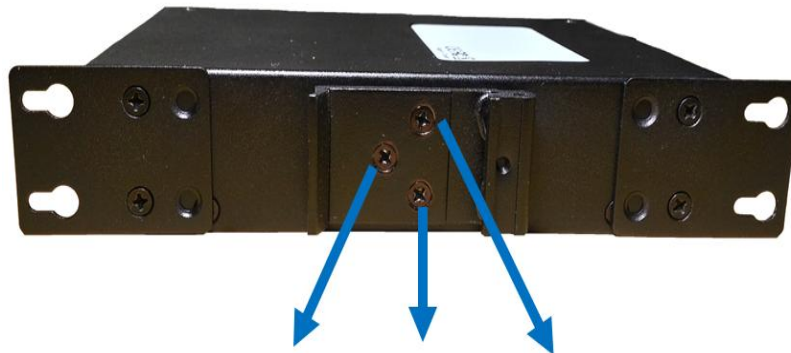
*Stable the Switch on DIN-Rail*

5. Check if the bracket is mounted tightly on the rail.
6. To remove the industrial Ethernet switch from the rail, do the opposite from the above steps.

## 3.2 Wall Mounting

Follow the steps below to mount the industrial Ethernet switch using the wall mounting bracket as shown below in *Figure 3.4*.

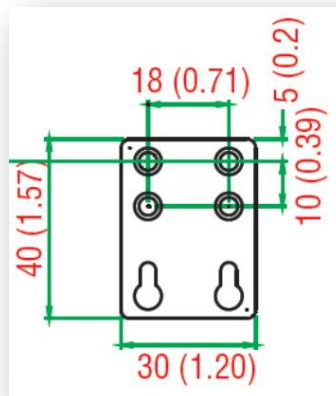
1. Remove the DIN-Rail bracket from the industrial Ethernet switch by loosening the screws.
2. Place the wall mounting brackets on the top and bottom of the industrial Ethernet switch.
3. Use the screws to screw the wall mounting bracket on the industrial Ethernet switch.
4. Use the hook holes at the corners of the wall mounting bracket to hang the industrial Ethernet switch on the wall.
5. To remove the wall mount bracket, do the opposite from the steps above.



*Figure 3.4*

*Remove DIN-Rail Bracket from the Switch*

Below, in *Figure 3.5* are the dimensions of the wall mounting bracket.



*Figure 3.5*

*Wall Mounting Bracket Dimensions*

## 4. Hardware Installation

### 4.1 Installation Steps

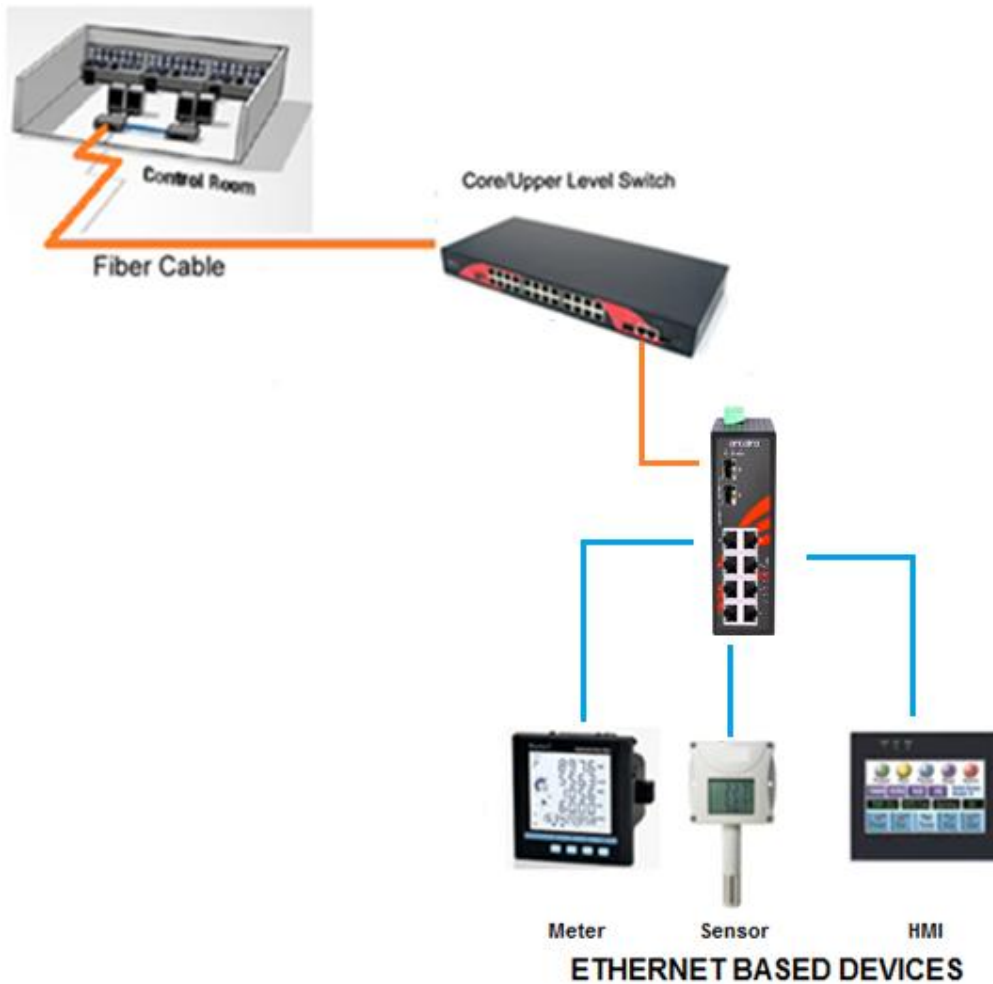
This section will explain how to install Antaira Technologies' LNX-0802C-SFP series: 8-port industrial unmanaged Ethernet switches, with 6\*10/100Tx, 2\* Gigabit combo ports (2\*10/100/1000Tx RJ45, and 2\*100/1000 SFP slots).

#### Installation Steps

1. Unpack the industrial Ethernet switch from the original packing box.
2. Check if the DIN-Rail bracket is screwed on the industrial Ethernet switch.
  - If the DIN-Rail is not screwed on the industrial Ethernet switch, please refer to the **DIN-Rail Mounting** section for DIN-Rail installation.
  - If you want to wall mount the industrial Ethernet switch, please refer to the **Wall Mounting** section for wall mounting installation.
3. To hang the industrial Ethernet switch on a DIN-Rail or wall, please refer to the **Mounting Installation** section.
4. Power on the industrial Ethernet switch and then the power LED light will turn on.
  - If you need help on how to wire power, please refer to the **Wiring the Power Inputs** section.
  - Please refer to the **LED Indicators** section for LED light indication.
5. Prepare the twisted-pair, straight-through or category 5e cable for Ethernet connection.
6. Insert one side of the RJ-45 cable into the switch's Ethernet port and on the other side into the networking device's Ethernet port, e.g. switch PC or server. The Ethernet port's (RJ-45) LED on the industrial Ethernet switch will turn on when the cable is connected to the networking device.
  - Please refer to the **LED Indicators** section for LED light indication.
7. When all connections are set and the LED lights all show normal, the installation is complete.

## 5. Network Application

This segment provides an example of an industrial Ethernet switch application (*Figure 5.1*).



*Figure 5.1*

*Industrial Ethernet Switch Application Reference*

## 6. Trouble Shooting

- Verify that the user has the right power cord or adapter. Never use a power supply or adapter with a non-compliant DC output voltage or it will burn the equipment.
- Select the proper UTP or STP cable in order to construct the network. Use an unshielded twisted-pair (UTP) or shielded twisted-pair (STP) cable for RJ-45 connections: 100Ω category 5e for 10M/100Mbps. Also be sure that the length of any twisted-pair connection does not exceed 100 meters (328 feet).
- **Diagnosing LED Indicators:** To assist in identifying problems, the switch can be easily monitored with the LED indicators which help to identify if any problems exist.
  - Please refer to the LED Indicators section for LED light indication.
- If the power indicator LED does not turn on when the power cord is plugged in, the user may have a problem with the power cord. Check for loose power connections, power losses or surges at the power outlet.
  - Please contact Antaira Technologies for technical support service at (844) 268-2472, if the problem still cannot be resolved.
- If the industrial switch LED indicators are normal and the connected cables are correct but the packets still cannot transmit, please check the system's Ethernet devices' configuration or status.

## 7. Technical Specifications

Table 7.1 has the technical specifications for Antaira Technologies' LNX-0802C-SFP series: 8-port industrial unmanaged switches, with 6\*10/100Tx, 2\* Gigabit combo ports (2\*10/100/1000Tx RJ45, and 2\*100/1000 SFP slots).

<b>Standard</b>	IEEE 802.3 10BaseT Ethernet IEEE 802.3u 100BaseTX Fast Ethernet IEEE 802.3ab 1000BaseT IEEE 802.3z gigabit Fiber
<b>Protocol</b>	CSMA/CD
<b>Transfer Rate</b>	14,880pps for Ethernet port 148,800pps for fast Ethernet port 1,488,000pps for gigabit Ethernet port
<b>Transmission Distance</b>	Up to 100M
<b>Transmission Speed</b>	Up to 1000Mbps
<b>MAC Address</b>	8K table size
<b>RJ45 (Ethernet) Port</b>	6*10/100Tx + 2* 10/100/1000Tx (Gigabit combo) auto negotiation speed, full/half duplex mode, and auto MDI/MDI-X connection
<b>SFP Slot</b>	2*100/1000 dual rate SFP for Fiber (Gigabit combo)
<b>LED</b>	Power Unit: P1 (Green), P2 (Green), Fault (Red) Ethernet port: Link/active (Green) SFP: Link/active (Green)
<b>Network Cable</b>	10BaseT: 2-pair UTP/STP Cat. 3, 4, 5 cable EIA/TIA-568 100-ohm (100m) 100BaseTX: 2-pair UTP/STP Cat. 5 cable EIA/TIA-568 100-ohm (100m) 1000BaseTX: UTP/STP Cat.5/5E cable; EIA/TIA-568 100-ohm (100m)
<b>Over Current Protection</b>	Single-blown fuse
<b>Power Input</b>	Redundant power DC 12~48V with connective 1*6-pin removable terminal block
<b>Fault Output</b>	1 Relay output
<b>Max Power Consumption</b>	10 Watts

<b>Installation</b>	DIN-Rail mounting, wall mounting (optional)
<b>Operating Temperature</b>	Standard: -10°C to 70°C (14° to 158°F) EOT: -40°C to 75°C (-40° to 167°F)
<b>Operating Humidity</b>	5% to 95% (Non-Condensing)
<b>Storage Temperature</b>	-40°C to 85°C (-40°F ~ 185°F)
<b>Case Dimension</b>	IP-30, 46mm (W) x 99mm (D) x 142mm (H)
<b>EMI</b>	FCC Class A CE EN61000-4-2,3,4,5,6,8 CE EN61000-6-2 CE EN61000-6-4
<b>Stability Testing</b>	IEC60068-2-32 (Free fall) IEC60068-2-27 (Shock) IEC60068-2-6 (Vibration)
<b>Safety</b>	FCC, CE, UL 61010-1, UL 61010-2-201 UL Class 1 Division 2, ISA 12.12.01

Table 7.1

*LNX-0802C-SFP Series Technical Specifications*

**Antaira Customer Service and Support**

(Antaira US Headquarter) + 844-268-2472

(Antaira Europe Office) + 48-22-862-88-81

(Antaira Asia Office) + 886-2-2218-9733

**Please report any problems to Antaira:**

[www.antaira.com](http://www.antaira.com) / [support@antaira.com](mailto:support@antaira.com)

[www.antaira.eu](http://www.antaira.eu) / [info@antaira.eu](mailto:info@antaira.eu)

[www.antaira.com.tw](http://www.antaira.com.tw) / [info@antaira.com.tw](mailto:info@antaira.com.tw)